



Ventilmotor s.r.l.

VENTILATORI CIVILI - INDUSTRIALI

**CENTRIFUGAL FANS
SERIE "EV-D"**

[**SERIE EV-D**]

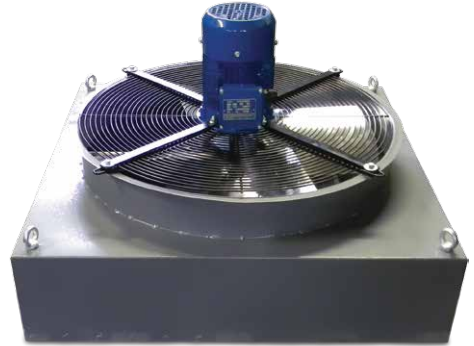

The "Stratifier" EV-D is a fan recycling the hot air, bringing it down and reducing the energy consumption for the heating. The saving can be up to 40%. To obtain a good result it's necessary to use a number of stratifier equal to 4 volumes/room/hour. The stratifier can be used also during the summer period to have a refreshing and airing effect.

MODEL	A	B	C	Pow. Inst. (kW)	RPM	Air Flow (m ³ /h)
EV-D 460	600	600	150	0.12	900	2900
EV-D 610	750	750	150	0.18	900	7000

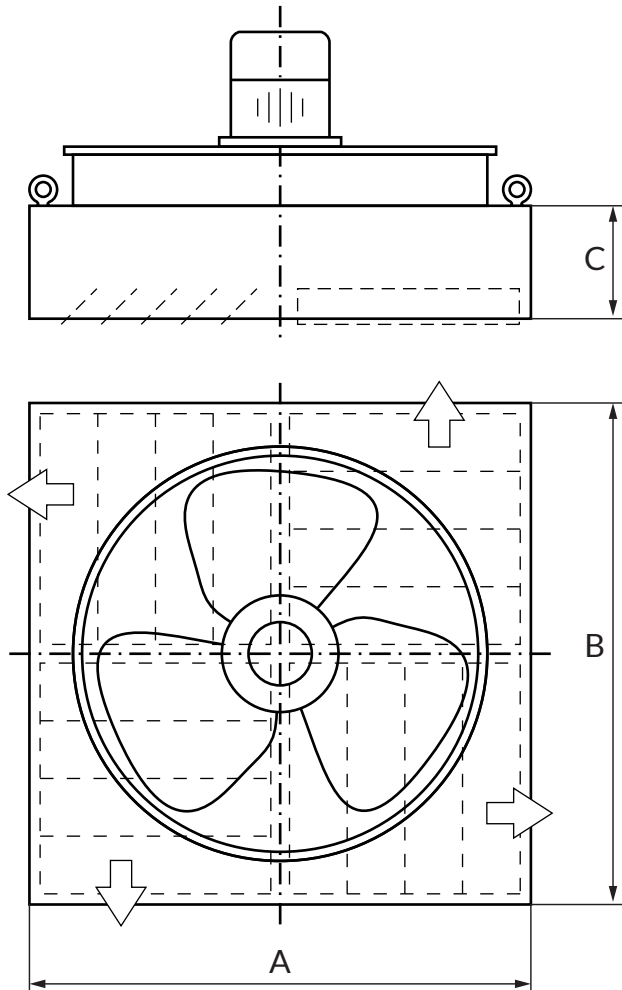

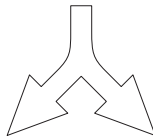
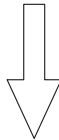
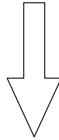
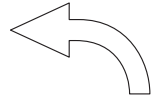
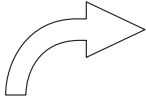
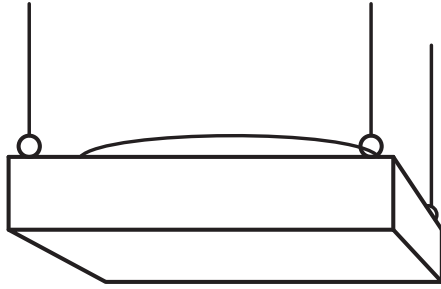

Ventilmotor s.r.l a socio unico ©2016

Uffici e Stabilimento: Via Piaggio, 74 - 20037 - Paderno Dugnano (MI) Sede Legale: Via G. Pogliani, 34 - Paderno Dugnano (MI)

Tel: +39 02.9101051 / +39 02.99041382 Fax: +39 02.9103661 Web: info@ventilmotor.com - www.ventilmotor.com

Capitale Sociale € 10400.00 i.v. - REA 1519030 - N° Registro Imprese MI 53691 - P. Iva 02632870966 - ITALY



Certificate n° 10-Q-10177-TIC