

The SERIE ETE roof fan is particularly suitable for large industrial ventilation, farms, stables, air supply or extraction of fumes. The supporting base is made of galvanized steel and the dome is made of fiberglass.

These air extractors, whose series consists of nine models, are ideal if you need to move large air volumes at relatively low pressures and maximum ambient temperature of 60 ° C.

Ventilmotor s.r.l. a socio unico

Uffici e Stabilimento: Via Piaggio, 74 - 20037 - Paderno Dugnano (MI) **Sede Legale:** Via G. Pogliani, 34 - Paderno Dugnano (MI)

Tel: +39 02.9101051 / +39 02.99041382 **Fax:** +39 02.9103661 **Web:** info@ventilmotor.com - www.ventilmotor.com

Capitale Sociale € 10400.00 i.v. - REA 1519030 - N° Registro Imprese MI 53691 - Partita IVA 02632870966



SERIE ETE

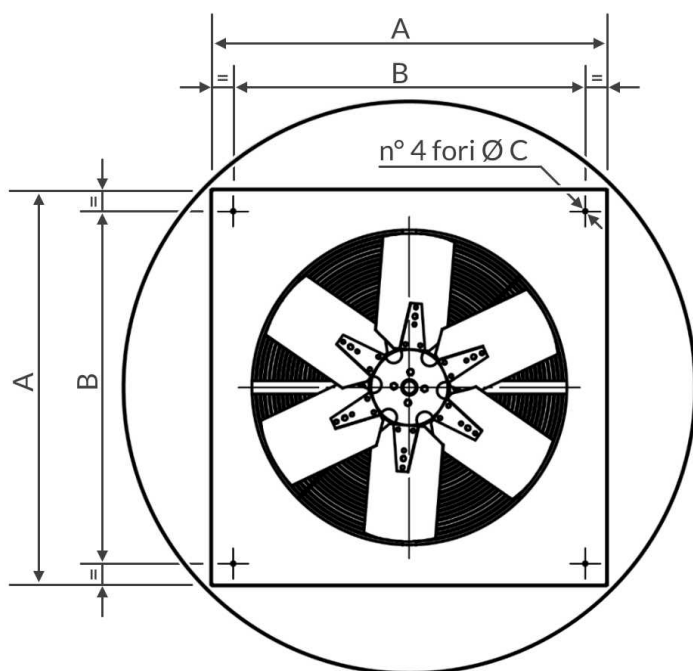
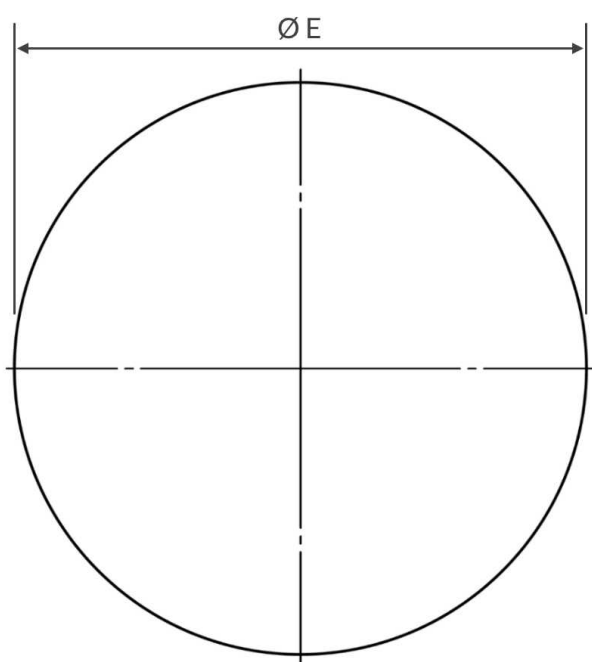
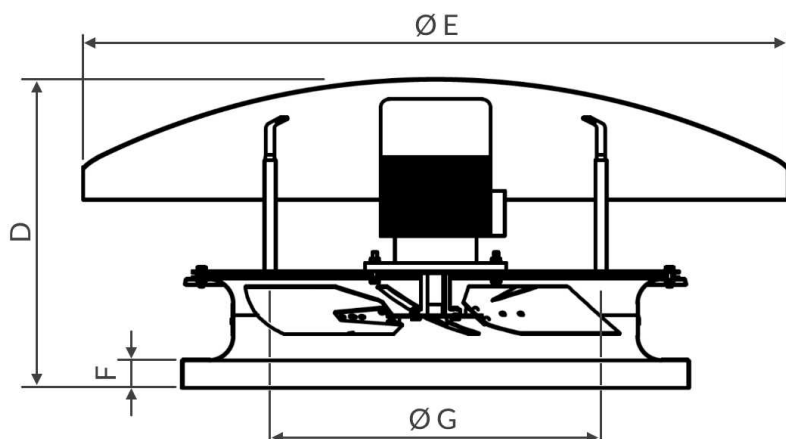

MODEL	A	B	C	D	E	F	G
ETE 260	350	300	8	350	560	35	265
ETE 310	400	350	8	400	800	50	315
ETE 360	450	400	8	440	800	50	365
ETE 410	500	450	9	440	800	50	420
ETE 510	600	550	9	520	1000	50	520
ETE 610	730	680	9	460	1250	50	620
ETE 710	900	800	9	470	1250	50	715
ETE 760	900	800	9	470	1250	50	780
ETE 910	1250	1150	14	650	1500	65	920

Ventilmotor s.r.l. a socio unico

Uffici e Stabilimento: Via Piaggio, 74 - 20037 - Paderno Dugnano (MI) **Sede Legale:** Via G. Pogliani, 34 - Paderno Dugnano (MI)

Tel: +39 02.9101051 / +39 02.99041382 **Fax:** +39 02.9103661 **Web:** info@ventilmotor.com - www.ventilmotor.com

Capitale Sociale € 10400.00 i.v. - REA 1519030 - N° Registro Imprese MI 53691 - Partita IVA 02632870966



Certificate n° 10-Q-10177-TIC



[ETE 260]

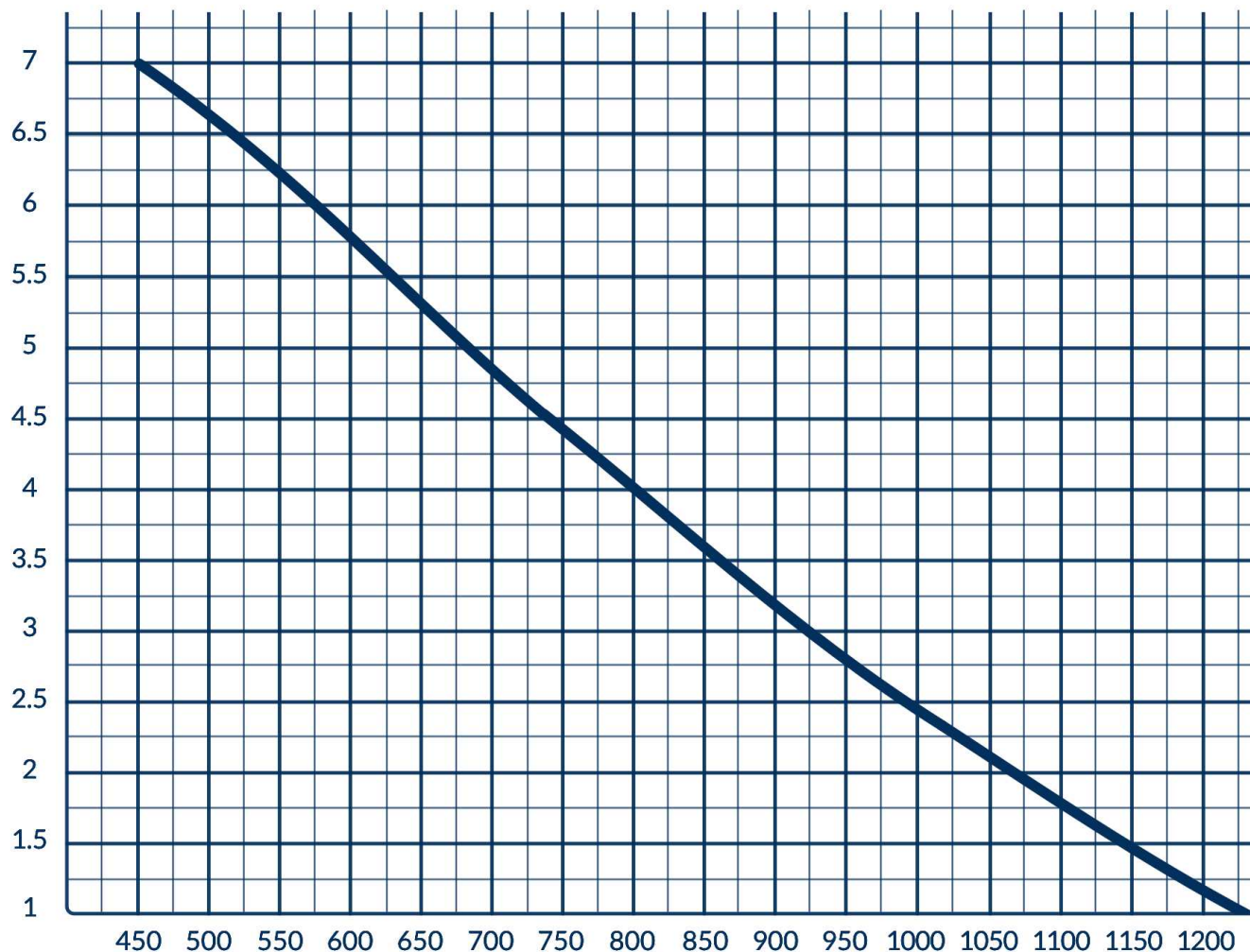

1400
rpm

0.12
kW

Ventilmotor s.r.l. a socio unico

Uffici e Stabilimento: Via Piaggio, 74 - 20037 - Paderno Dugnano (MI) **Sede Legale:** Via G. Pogliani, 34 - Paderno Dugnano (MI)

Tel: +39 02.9101051 / +39 02.99041382 **Fax:** +39 02.9103661 **Web:** info@ventilmotor.com - www.ventilmotor.com

Capitale Sociale € 10400.00 i.v. - REA 1519030 - N° Registro Imprese MI 53691 - Partita IVA 02632870966



Certificate n° 10-Q-10177-TIC



[ETE 310]

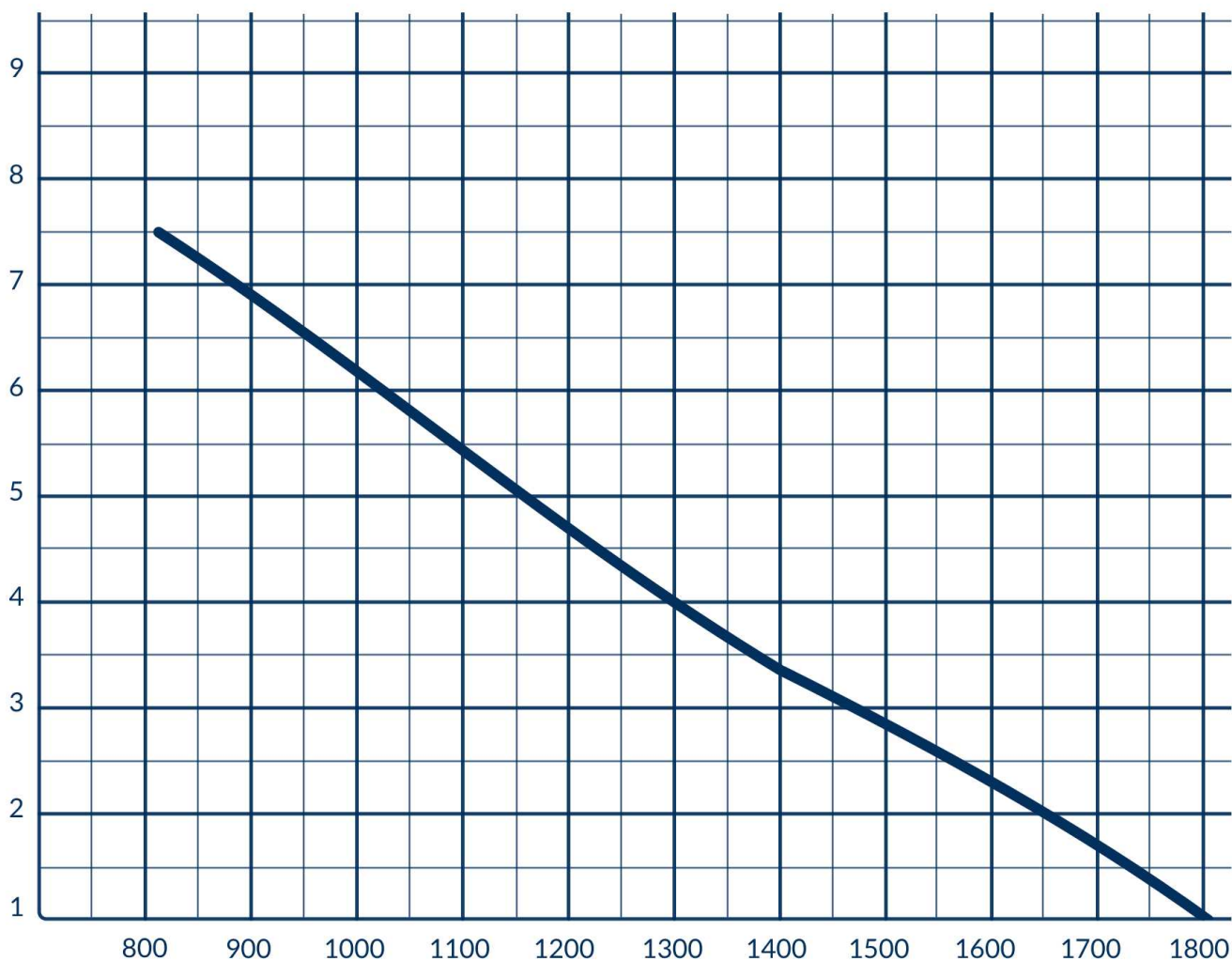

1400
rpm

0.12
kW

Ventilmotor s.r.l. a socio unico

Uffici e Stabilimento: Via Piaggio, 74 - 20037 - Paderno Dugnano (MI) **Sede Legale:** Via G. Pogliani, 34 - Paderno Dugnano (MI)

Tel: +39 02.9101051 / +39 02.99041382 **Fax:** +39 02.9103661 **Web:** info@ventilmotor.com - www.ventilmotor.com

Capitale Sociale € 10400.00 i.v. - REA 1519030 - N° Registro Imprese MI 53691 - Partita IVA 02632870966



Certificate n° 10-Q-10177-TIC



[ETE 360]

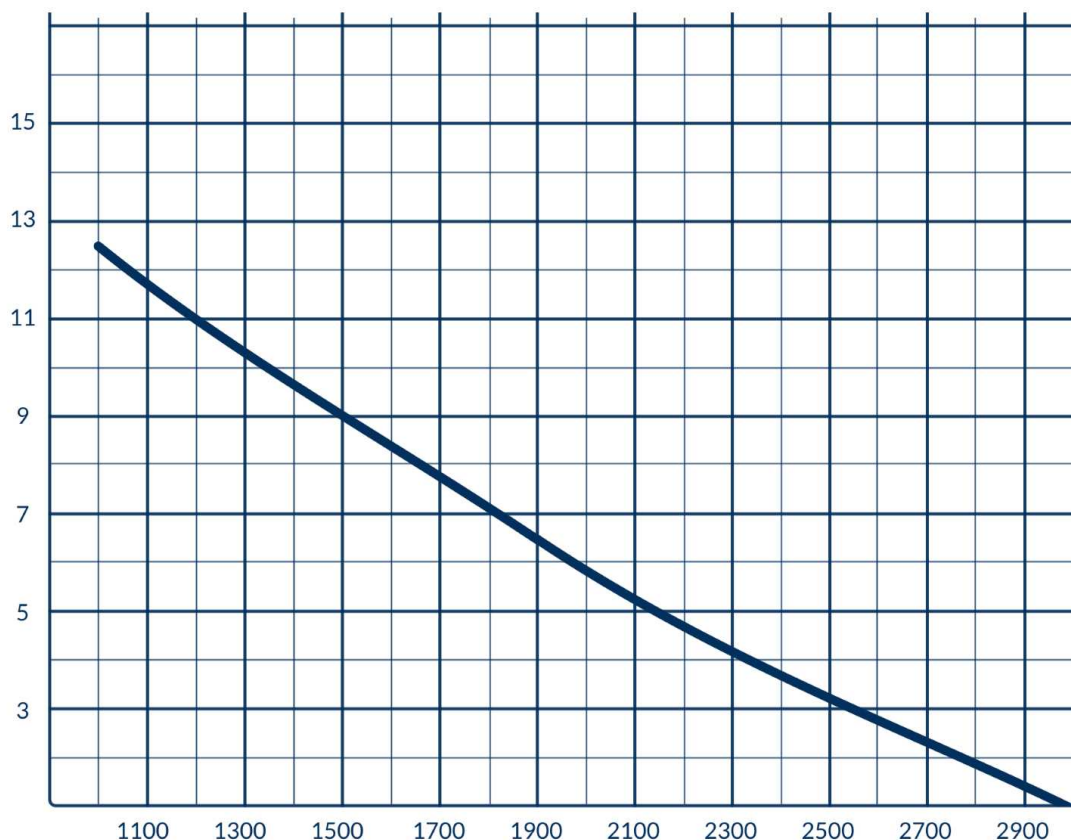

1400
rpm

0.18
kW

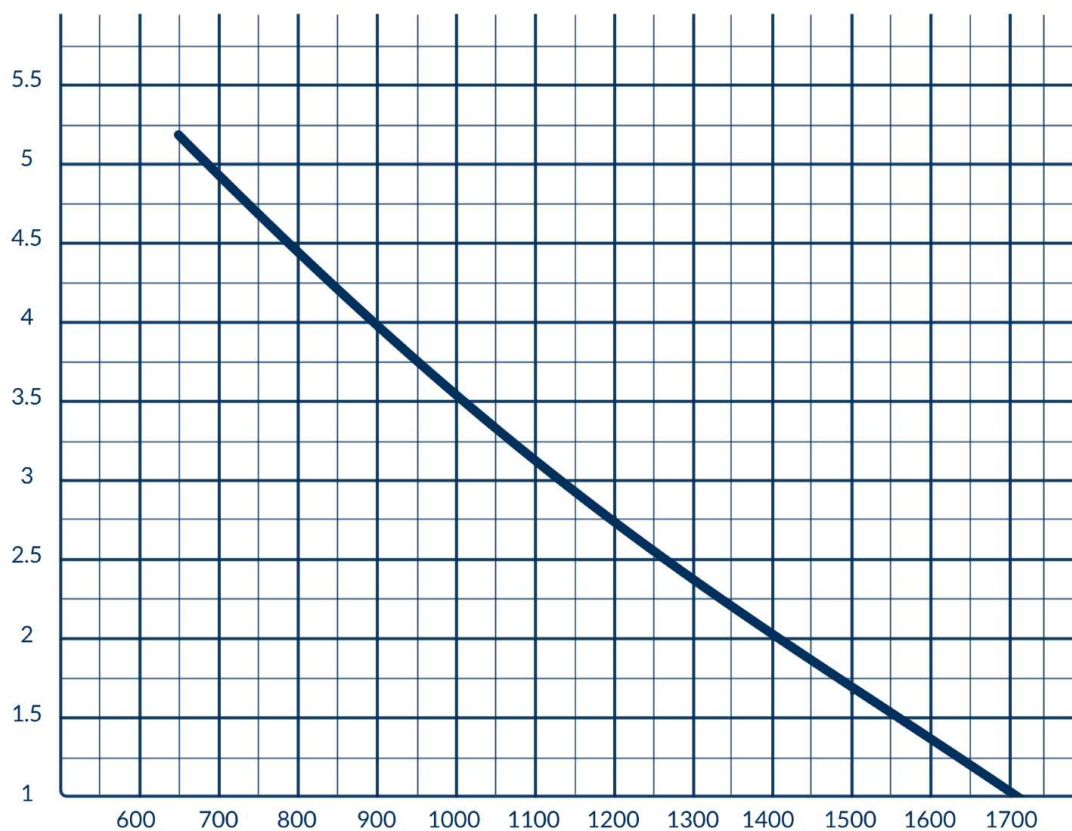

900
rpm

0.18
kW

Ventilmotor s.r.l. a socio unico

Uffici e Stabilimento: Via Piaggio, 74 - 20037 - Paderno Dugnano (MI) **Sede Legale:** Via G. Pogliani, 34 - Paderno Dugnano (MI)

Tel: +39 02.9101051 / +39 02.99041382 **Fax:** +39 02.9103661 **Web:** info@ventilmotor.com - www.ventilmotor.com

Capitale Sociale € 10400.00 i.v. - REA 1519030 - N° Registro Imprese MI 53691 - Partita IVA 02632870966



Certificate n° 10-Q-10177-TIC



[ETE 410]

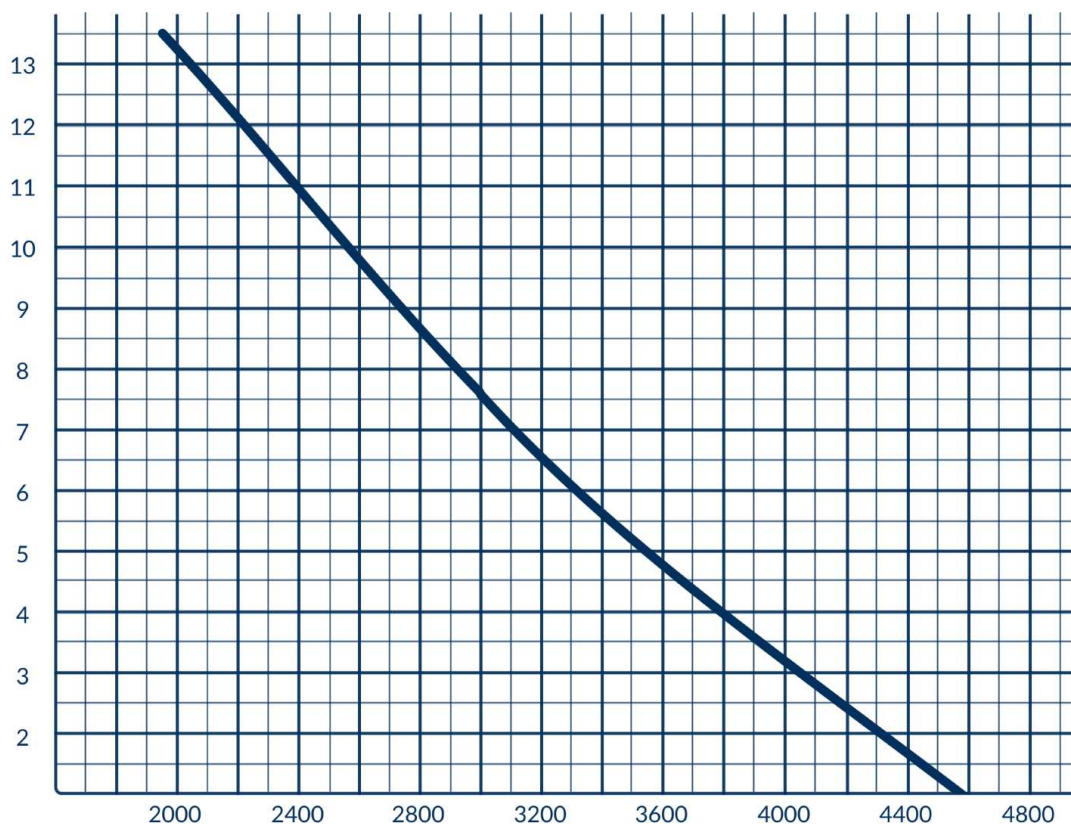

1400
rpm

0.25
kW

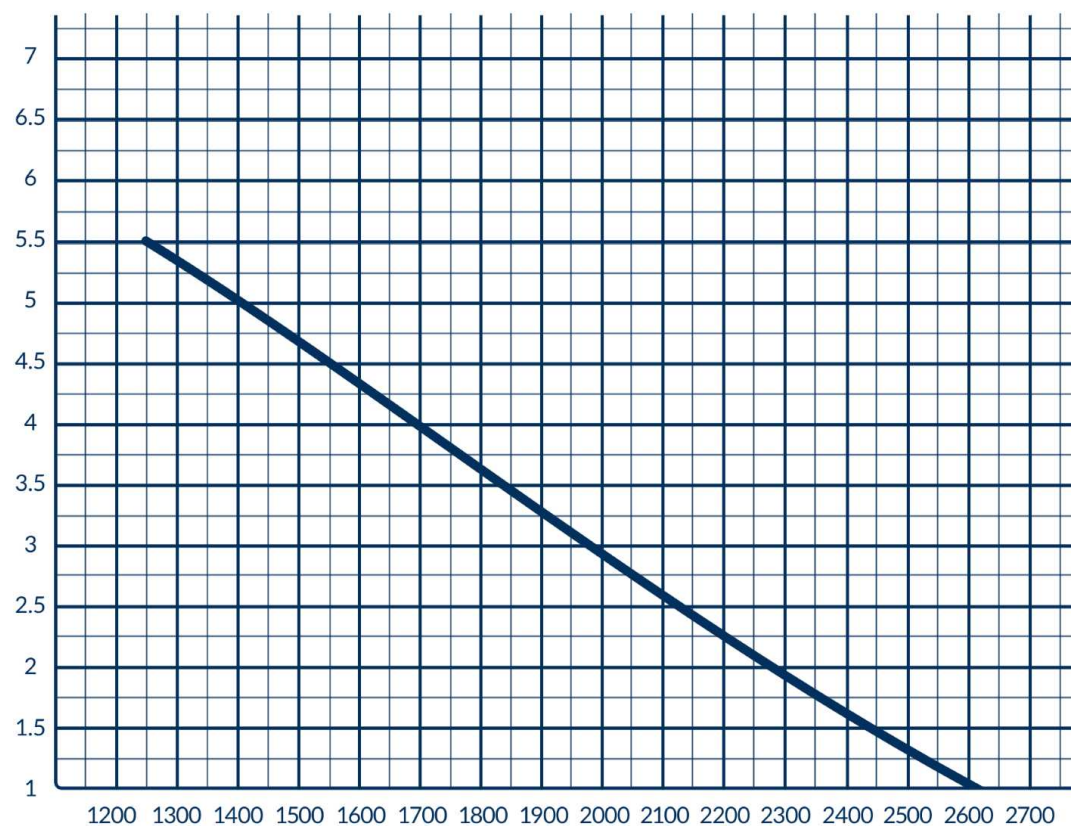

900
rpm

0.18
kW

Ventilmotor s.r.l. a socio unico

Uffici e Stabilimento: Via Piaggio, 74 - 20037 - Paderno Dugnano (MI) **Sede Legale:** Via G. Pogliani, 34 - Paderno Dugnano (MI)

Tel: +39 02.9101051 / +39 02.99041382 **Fax:** +39 02.9103661 **Web:** info@ventilmotor.com - www.ventilmotor.com

Capitale Sociale € 10400.00 i.v. - REA 1519030 - N° Registro Imprese MI 53691 - Partita IVA 02632870966



Certificate n° 10-Q-10177-TIC



[ETE 510]

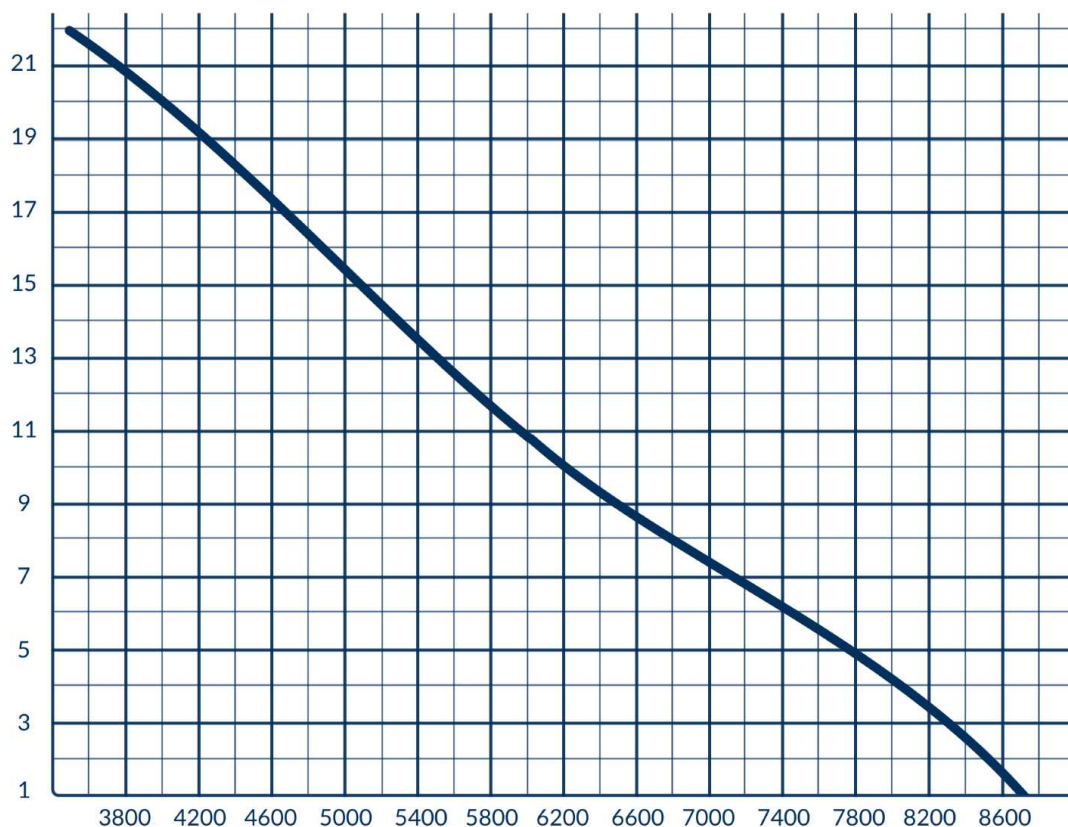

1400
rpm

0.75
kW

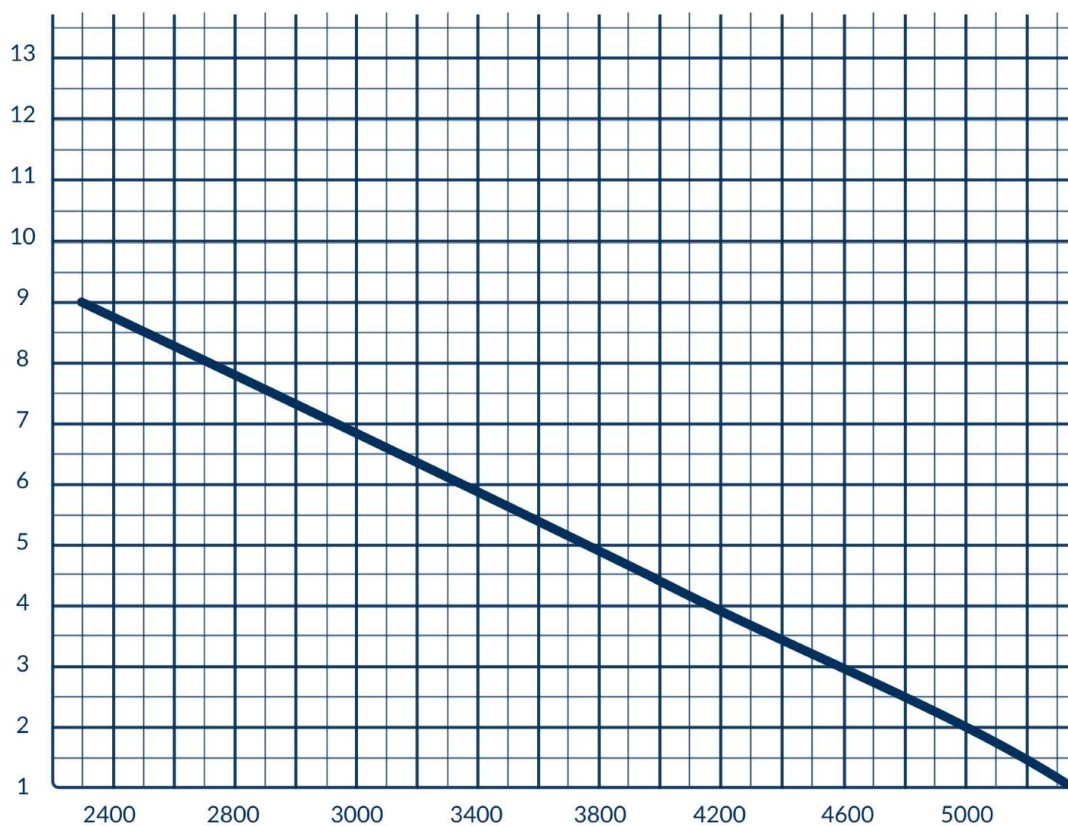

900
rpm

0.25
kW

Ventilmotor s.r.l. a socio unico

Uffici e Stabilimento: Via Piaggio, 74 - 20037 - Paderno Dugnano (MI) **Sede Legale:** Via G. Pogliani, 34 - Paderno Dugnano (MI)

Tel: +39 02.9101051 / +39 02.99041382 **Fax:** +39 02.9103661 **Web:** info@ventilmotor.com - www.ventilmotor.com

Capitale Sociale € 10400.00 i.v. - REA 1519030 - N° Registro Imprese MI 53691 - Partita IVA 02632870966



Certificate n° 10-Q-10177-TIC



[ETE 610]

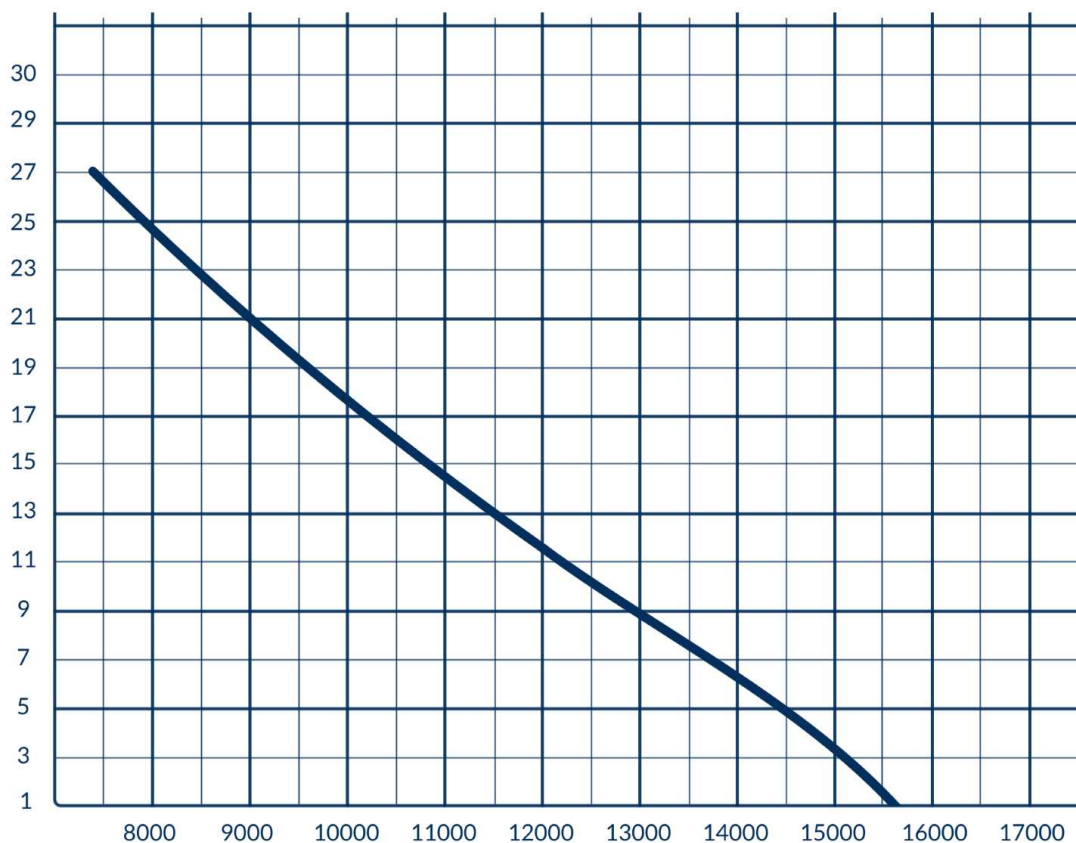

1400
rpm

1.5
kW

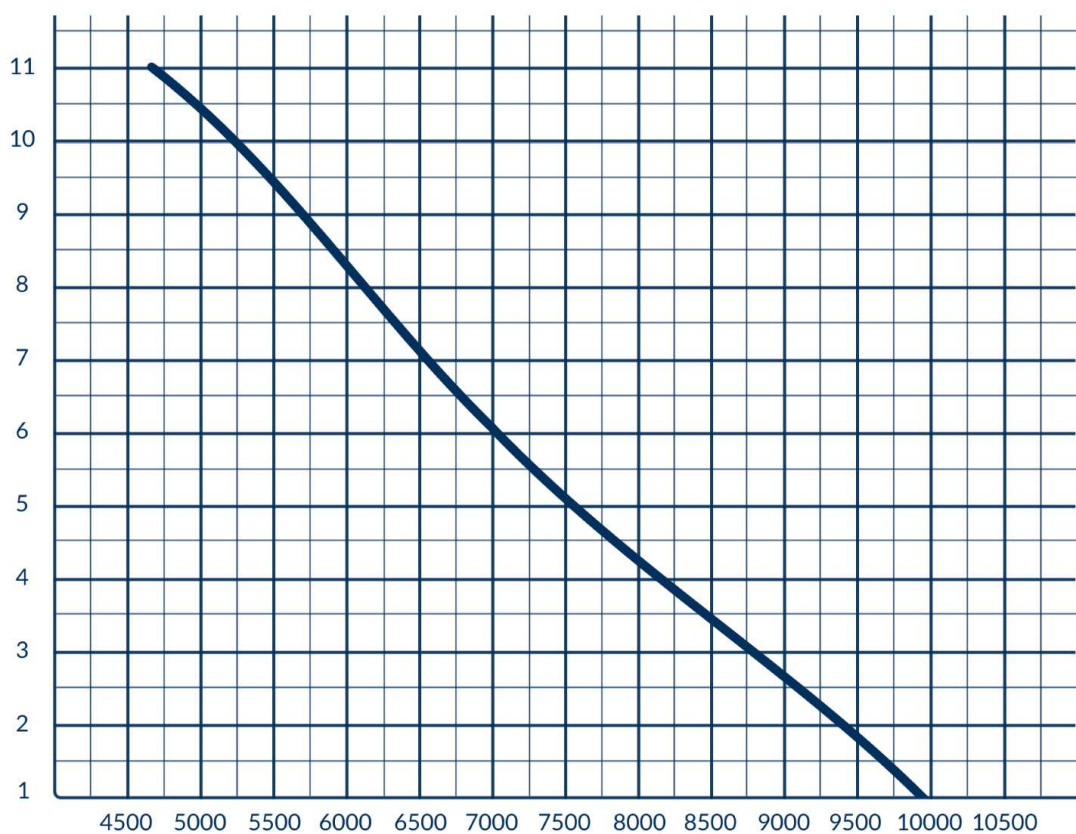

900
rpm

0.5
kW

Ventilmotor s.r.l. a socio unico

Uffici e Stabilimento: Via Piaggio, 74 - 20037 - Paderno Dugnano (MI) **Sede Legale:** Via G. Pogliani, 34 - Paderno Dugnano (MI)

Tel: +39 02.9101051 / +39 02.99041382 **Fax:** +39 02.9103661 **Web:** info@ventilmotor.com - www.ventilmotor.com

Capitale Sociale € 10400.00 i.v. - REA 1519030 - N° Registro Imprese MI 53691 - Partita IVA 02632870966



Certificate n° 10-Q-10177-TIC



[ETE 710]

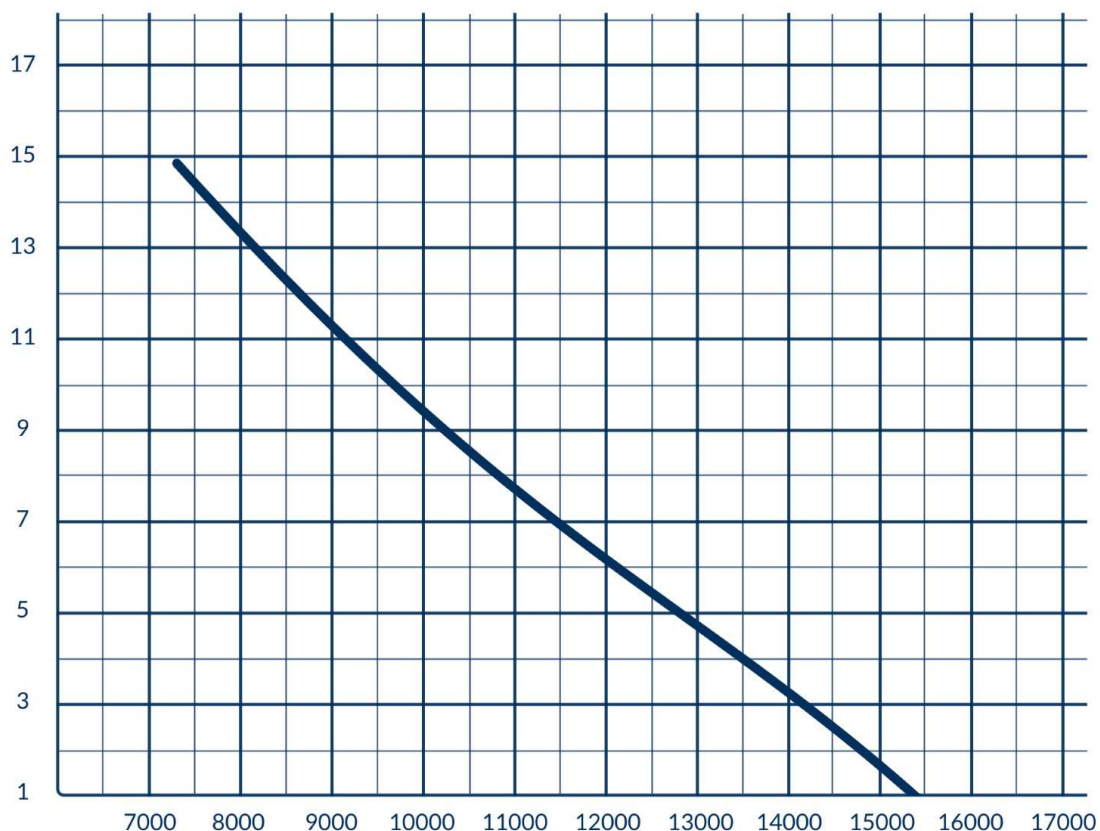

900
rpm

1.1
kW

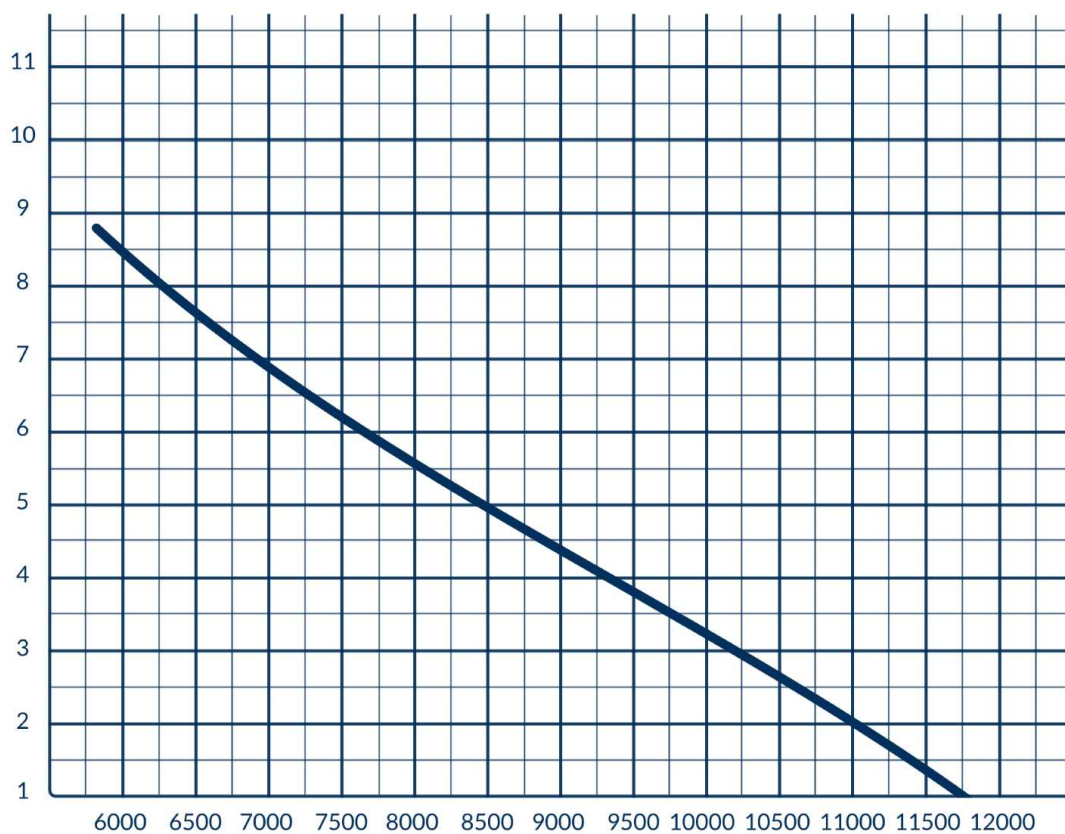

700
rpm

0.75
kW

Ventilmotor s.r.l. a socio unico

Uffici e Stabilimento: Via Piaggio, 74 - 20037 - Paderno Dugnano (MI) **Sede Legale:** Via G. Pogliani, 34 - Paderno Dugnano (MI)

Tel: +39 02.9101051 / +39 02.99041382 **Fax:** +39 02.9103661 **Web:** info@ventilmotor.com - www.ventilmotor.com

Capitale Sociale € 10400.00 i.v. - REA 1519030 - N° Registro Imprese MI 53691 - Partita IVA 02632870966



Certificate n° 10-Q-10177-TIC



[ETE 760]

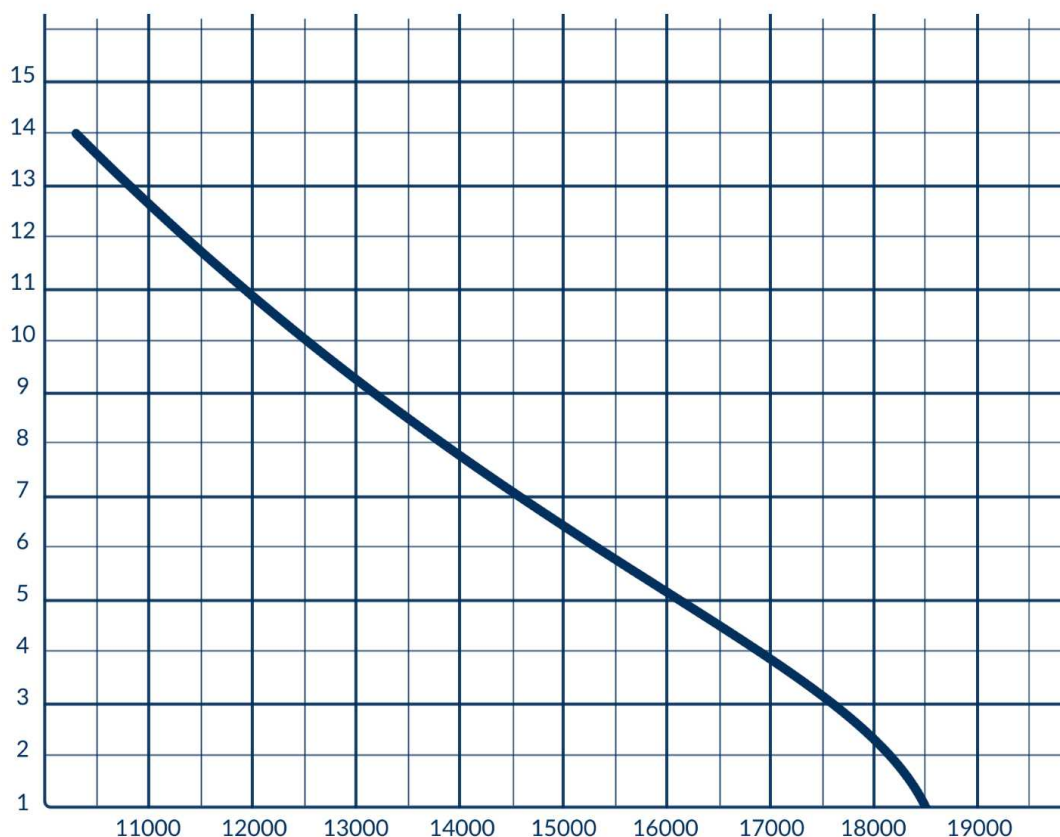

900
rpm

1.5
kW

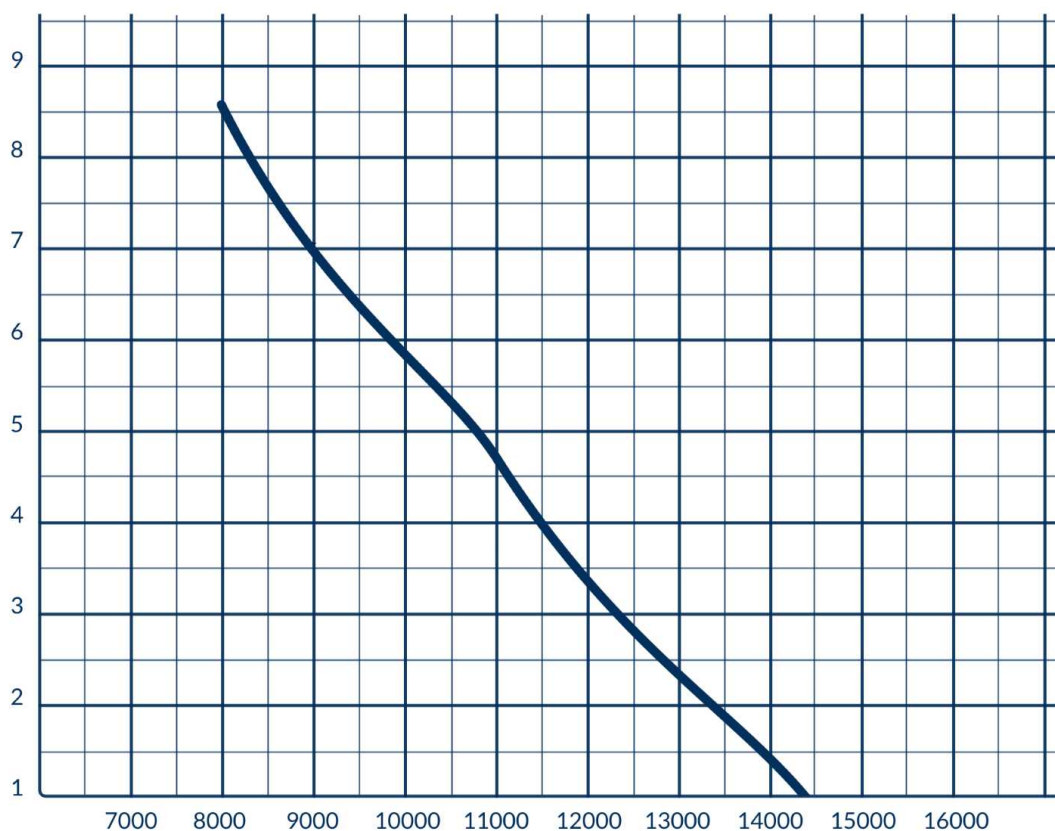

700
rpm

0.75
kW

Ventilmotor s.r.l. a socio unico

Uffici e Stabilimento: Via Piaggio, 74 - 20037 - Paderno Dugnano (MI) **Sede Legale:** Via G. Pogliani, 34 - Paderno Dugnano (MI)

Tel: +39 02.9101051 / +39 02.99041382 **Fax:** +39 02.9103661 **Web:** info@ventilmotor.com - www.ventilmotor.com

Capitale Sociale € 10400.00 i.v. - REA 1519030 - N° Registro Imprese MI 53691 - Partita IVA 02632870966



Certificate n° 10-Q-10177-TIC



[ETE 910]

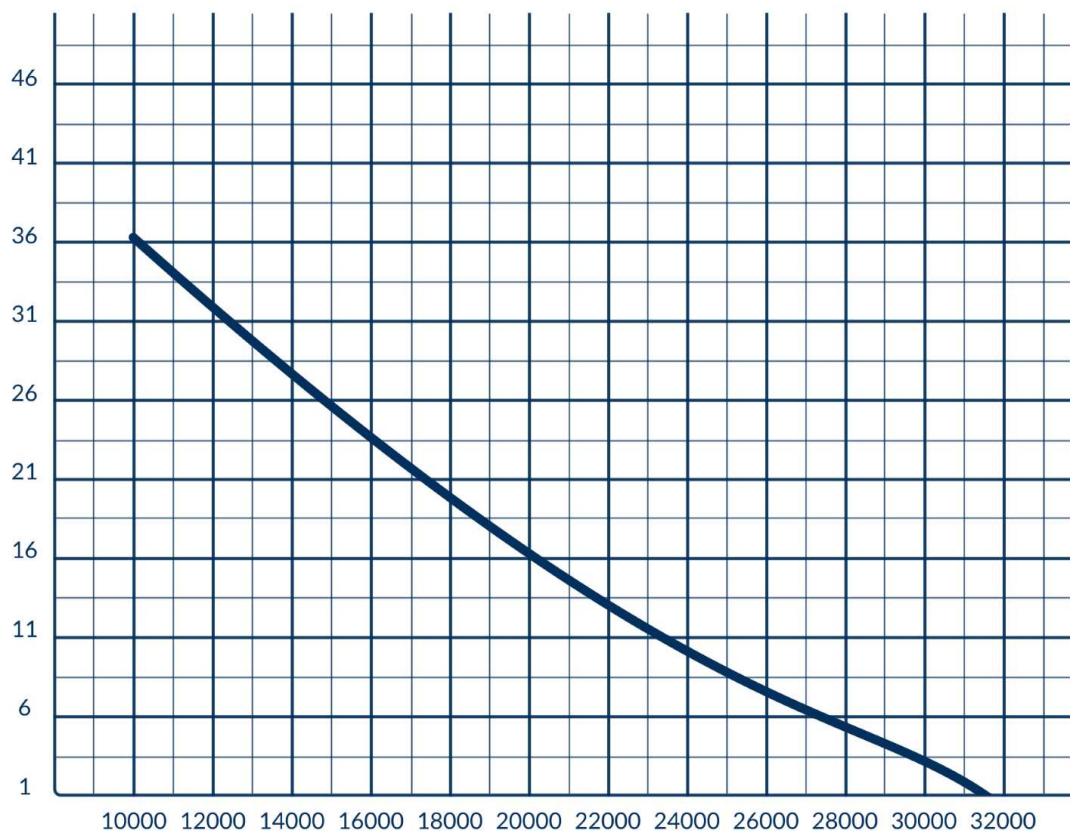

900
rpm

3
kW

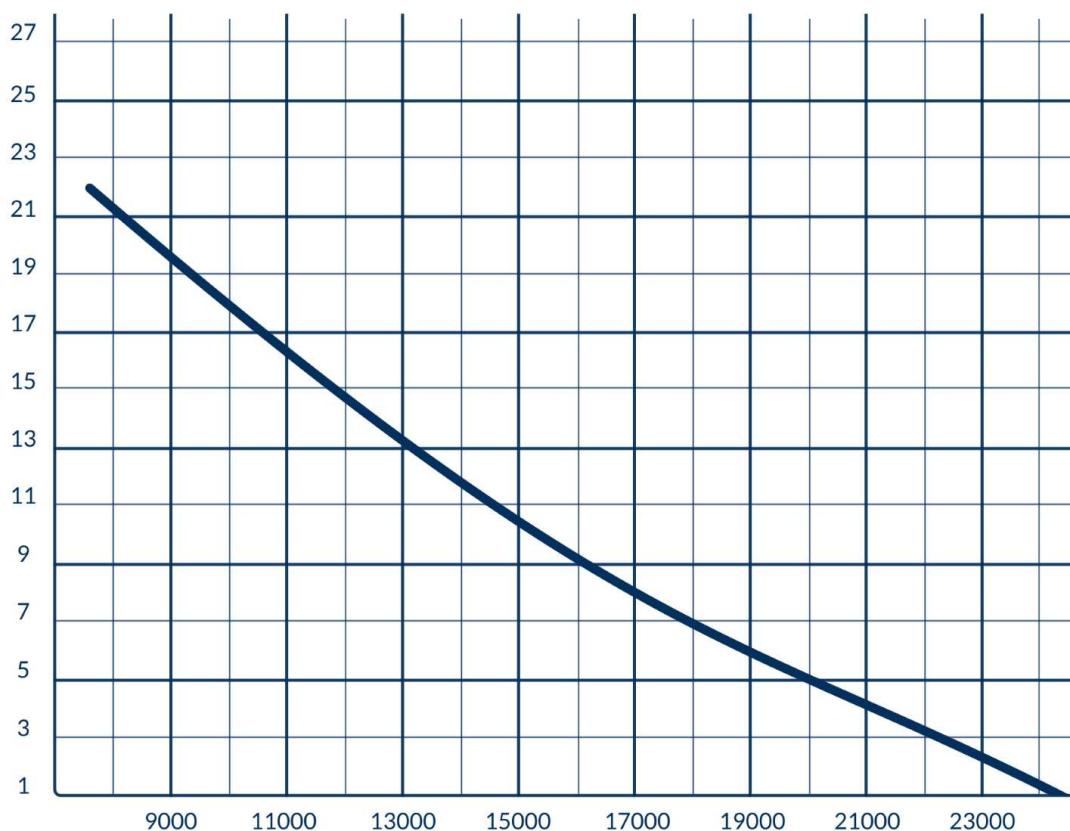

700
rpm

1.5
kW

Ventilmotor s.r.l. a socio unico

Uffici e Stabilimento: Via Piaggio, 74 - 20037 - Paderno Dugnano (MI) **Sede Legale:** Via G. Pogliani, 34 - Paderno Dugnano (MI)

Tel: +39 02.9101051 / +39 02.99041382 **Fax:** +39 02.9103661 **Web:** info@ventilmotor.com - www.ventilmotor.com

Capitale Sociale € 10400.00 i.v. - REA 1519030 - N° Registro Imprese MI 53691 - Partita IVA 02632870966



Certificate n° 10-Q-10177-TIC