



The SERIE ET roof centrifugal fans are especially suited to applications where it is necessary to suck clean air or fumes at temperatures up to 70°C. The base is produced in steel and the fan dome is produced in plastic reinforced by fiber glass.

These extractors, whose series consists of nine models suitable for extracting stale air from civil and industrial buildings and especially toilets, kitchens, etc ...

Each set consists of:

- Base, stands, motor support, and the safety net in galvanized steel
- Fiberglass protective dome
- Backward impeller made of steel sheet

Ventilmotor s.r.l. a socio unico

Uffici e Stabilimento: Via Piaggio, 74 - 20037 - Paderno Dugnano (MI) **Sede Legale:** Via G. Pogliani, 34 - Paderno Dugnano (MI)

Tel: +39 02.9101051 / +39 02.99041382 **Fax:** +39 02.9103661 **Web:** info@ventilmotor.com - www.ventilmotor.com

Capitale Sociale € 10400.00 i.v. - REA 1519030 - N° Registro Imprese MI 53691 - Partita IVA 02632870966



Measures and size

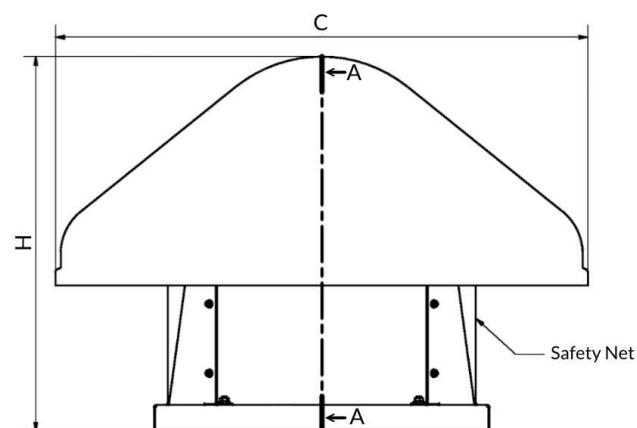
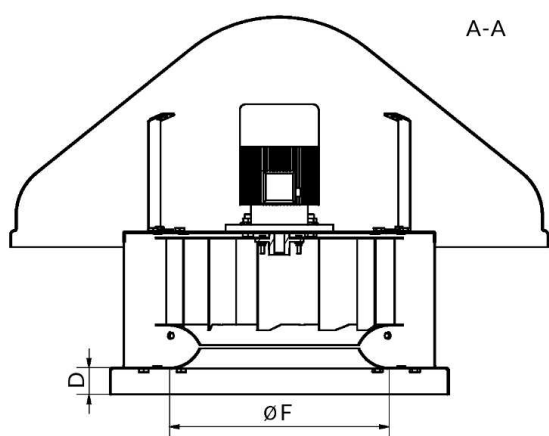
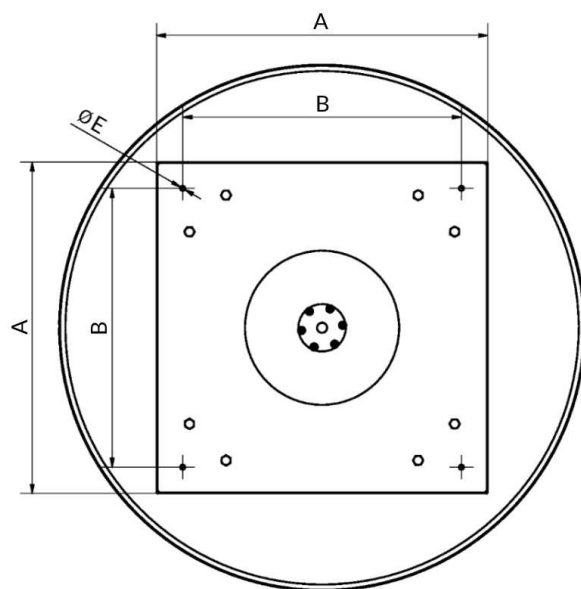

| Model | A | B | C | D | E | F | H |
|-------------|-----|-----|------|----|---|-----|-----|
| ET21 | 350 | 300 | 390 | 35 | 8 | 240 | 275 |
| ET24 | 350 | 300 | 600 | 35 | 8 | 240 | 275 |
| ET27 | 400 | 340 | 600 | 50 | 9 | 265 | 305 |
| ET32 | 500 | 400 | 1000 | 50 | 9 | 315 | 355 |
| ET37 | 560 | 460 | 1000 | 50 | 9 | 365 | 415 |
| ET42 | 630 | 530 | 1000 | 50 | 9 | 420 | 468 |
| ET47 | 710 | 610 | 1000 | 50 | 9 | 470 | 512 |
| ET52 | 800 | 700 | 1600 | 50 | 9 | 520 | 565 |
| ET57 | 900 | 800 | 1600 | 50 | 9 | 570 | 625 |
| ET62 | 900 | 800 | 1600 | 50 | 9 | 620 | 675 |

Ventilmotor s.r.l. a socio unico

Uffici e Stabilimento: Via Piaggio, 74 - 20037 - Paderno Dugnano (MI) **Sede Legale:** Via G. Pogliani, 34 - Paderno Dugnano (MI)

Tel: +39 02.9101051 / +39 02.99041382 **Fax:** +39 02.9103661 **Web:** info@ventilmotor.com - www.ventilmotor.com

Capitale Sociale € 10400.00 i.v. - REA 1519030 - N° Registro Imprese MI 53691 - Partita IVA 02632870966



Certificate n° 10-Q-10177-TIC



[ET 21]

[The model ET21 includes the dome made of aluminum]

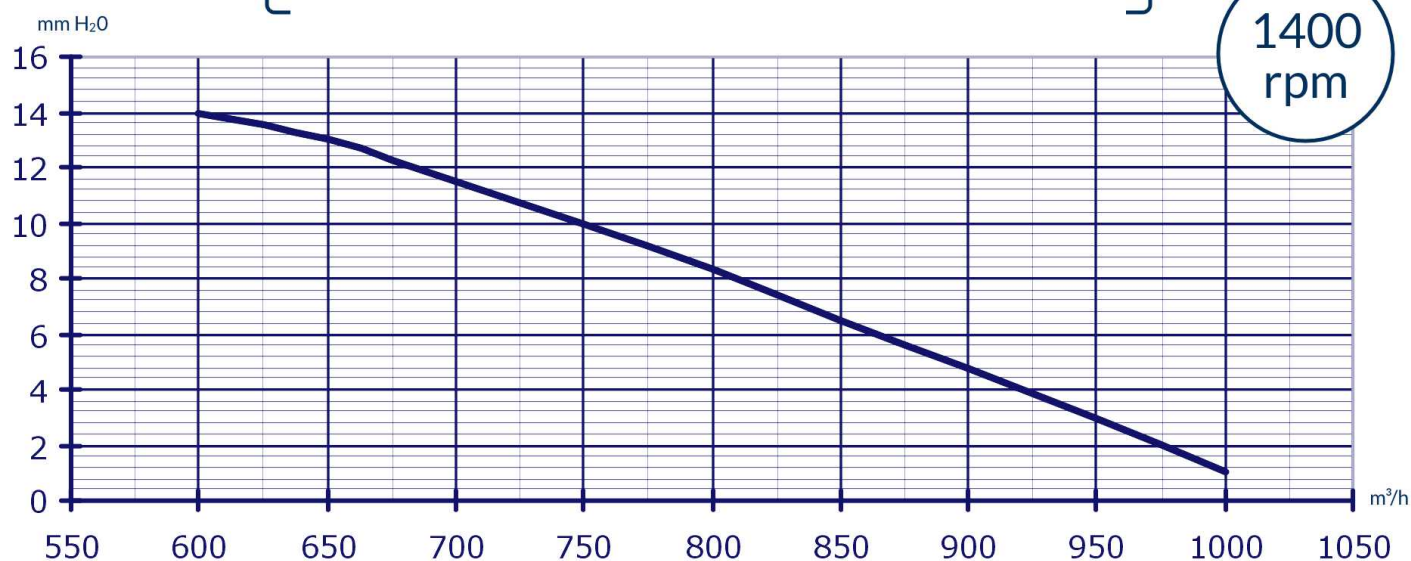

1400 rpm

[0.12kW]

[54dBA]

[18Kg]

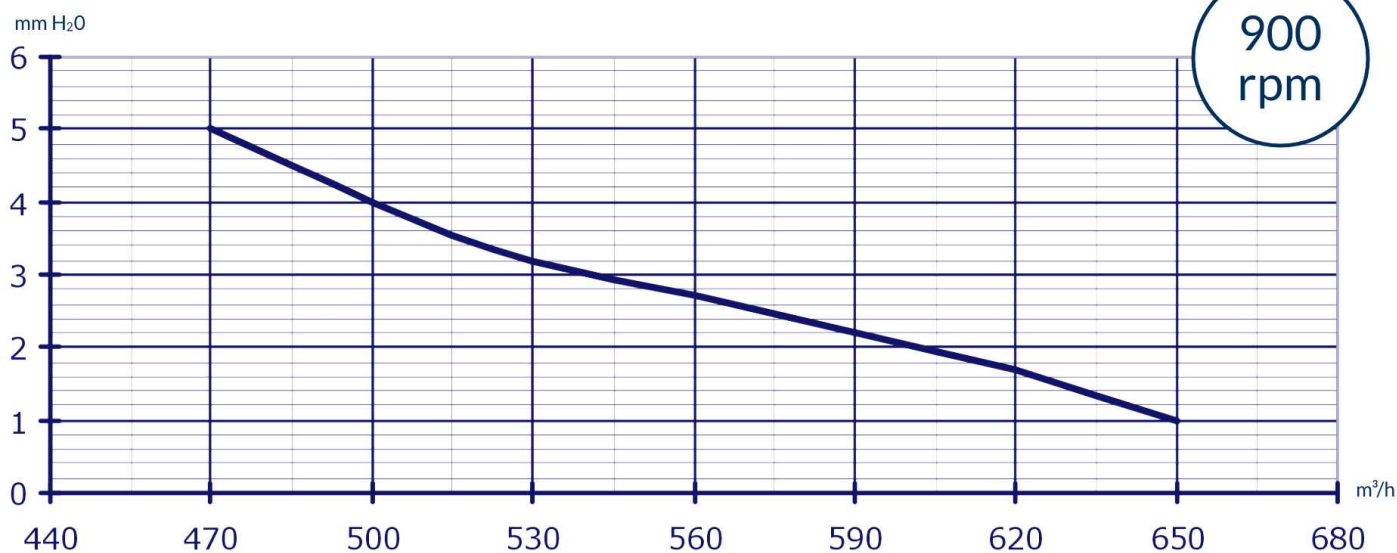

900 rpm

[0.09kW]

[43dBA]

[18Kg]

Ventilmotor s.r.l. a socio unico

Uffici e Stabilimento: Via Piaggio, 74 - 20037 - Paderno Dugnano (MI) Sede Legale: Via G. Pogliani, 34 - Paderno Dugnano (MI)

Tel: +39 02.9101051 / +39 02.99041382 Fax: +39 02.9103661 Web: info@ventilmotor.com - www.ventilmotor.com

Capitale Sociale € 10400.00 i.v. - REA 1519030 - N° Registro Imprese MI 53691 - Partita IVA 02632870966



Certificate n° 10-Q-10177-TIC



[ET 24]

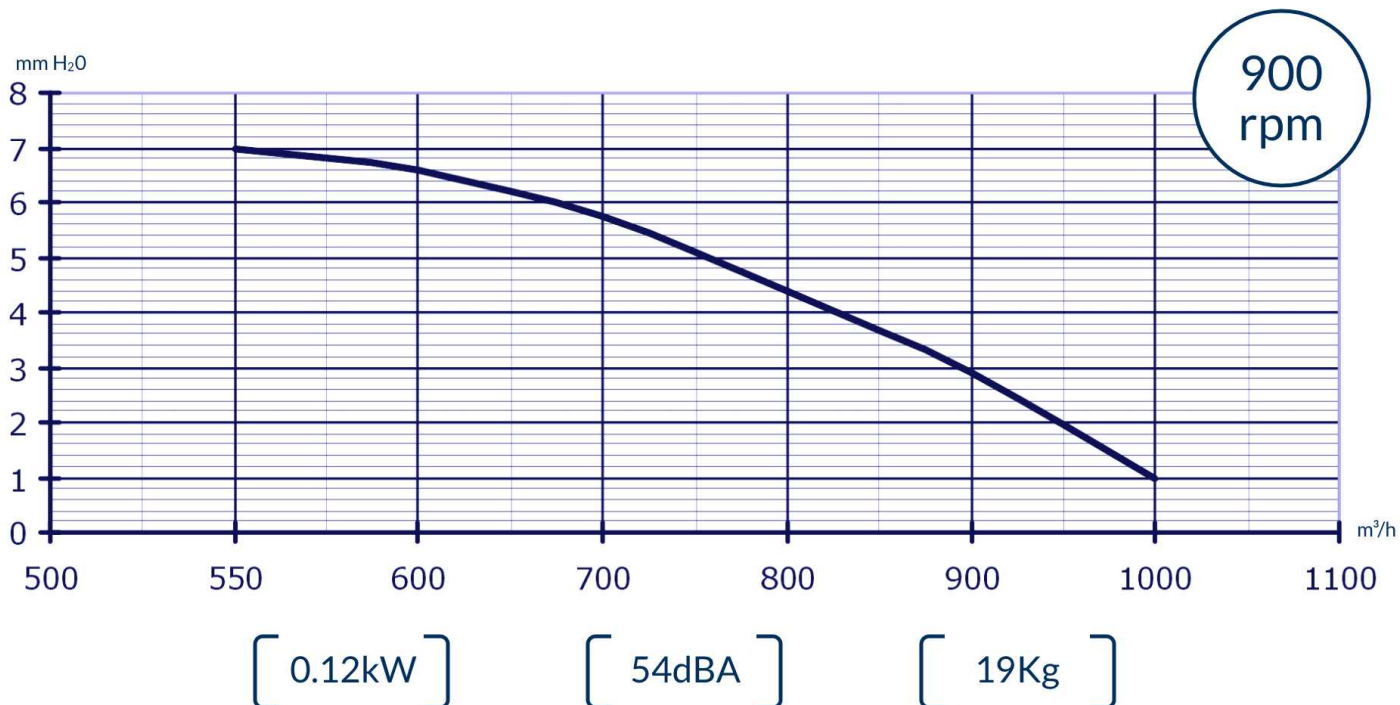
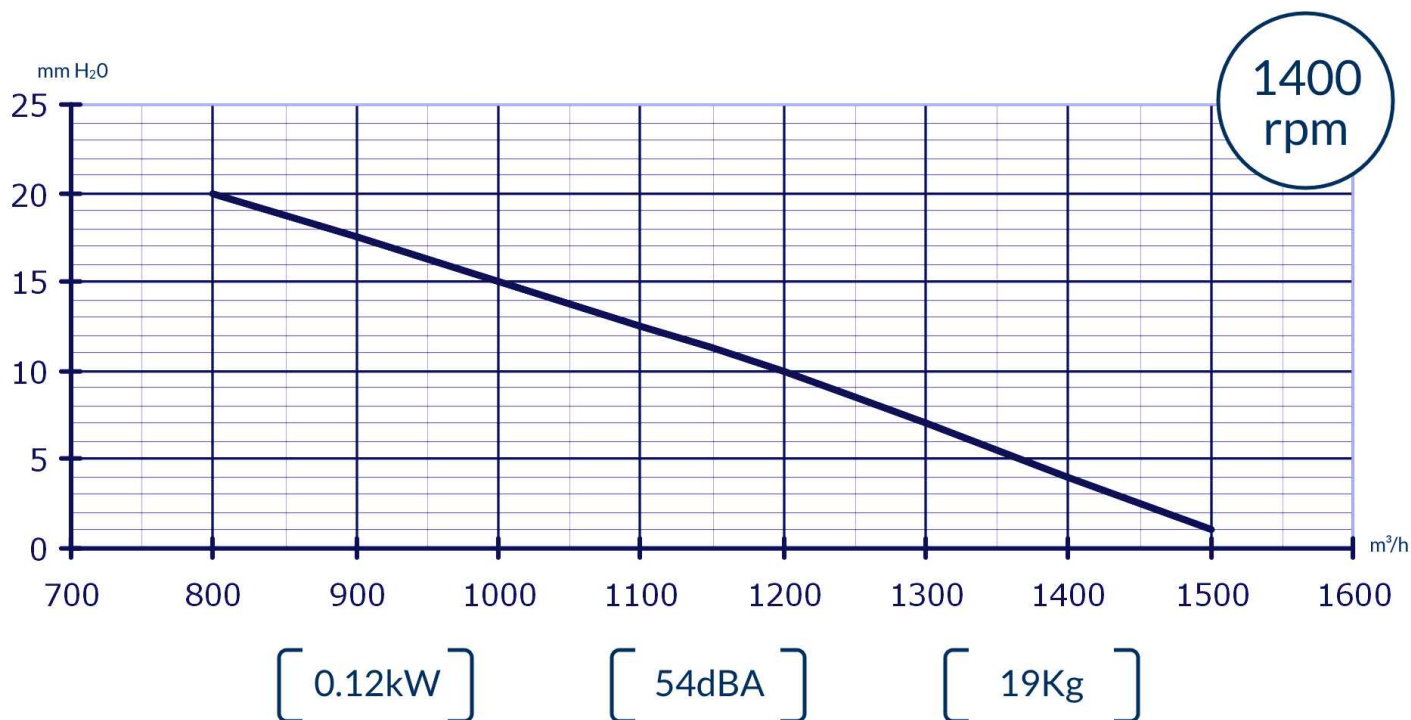

Ventilmotor s.r.l. a socio unico

Uffici e Stabilimento: Via Piaggio, 74 - 20037 - Paderno Dugnano (MI) **Sede Legale:** Via G. Pogliani, 34 - Paderno Dugnano (MI)

Tel: +39 02.9101051 / +39 02.99041382 **Fax:** +39 02.9103661 **Web:** info@ventilmotor.com - www.ventilmotor.com

Capitale Sociale € 10400.00 i.v. - REA 1519030 - N° Registro Imprese MI 53691 - Partita IVA 02632870966



Certificate n° 10-Q-10177-TIC



[ET 27]

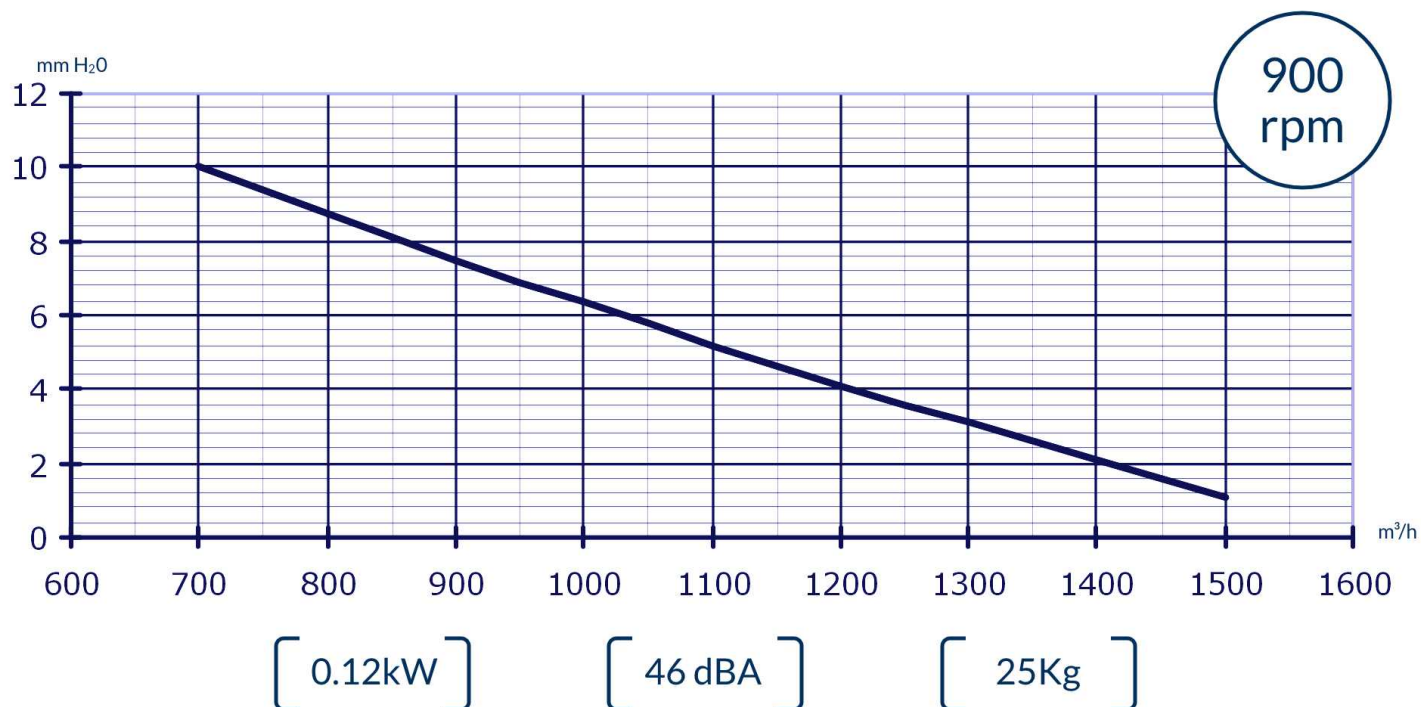
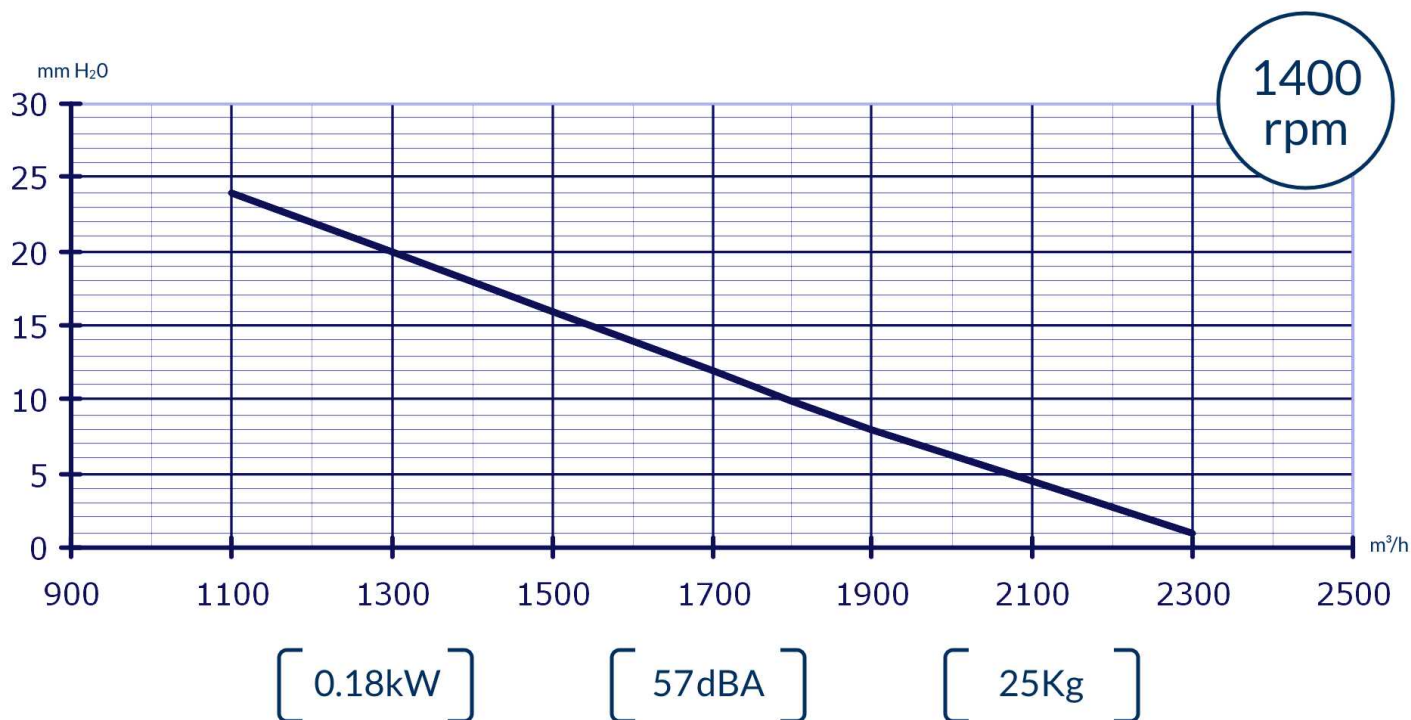

Ventilmotor s.r.l. a socio unico

Uffici e Stabilimento: Via Piaggio, 74 - 20037 - Paderno Dugnano (MI) **Sede Legale:** Via G. Pogliani, 34 - Paderno Dugnano (MI)

Tel: +39 02.9101051 / +39 02.99041382 **Fax:** +39 02.9103661 **Web:** info@ventilmotor.com - www.ventilmotor.com

Capitale Sociale € 10400.00 i.v. - REA 1519030 - N° Registro Imprese MI 53691 - Partita IVA 02632870966



Certificate n° 10-Q-10177-TIC



[ET 32]

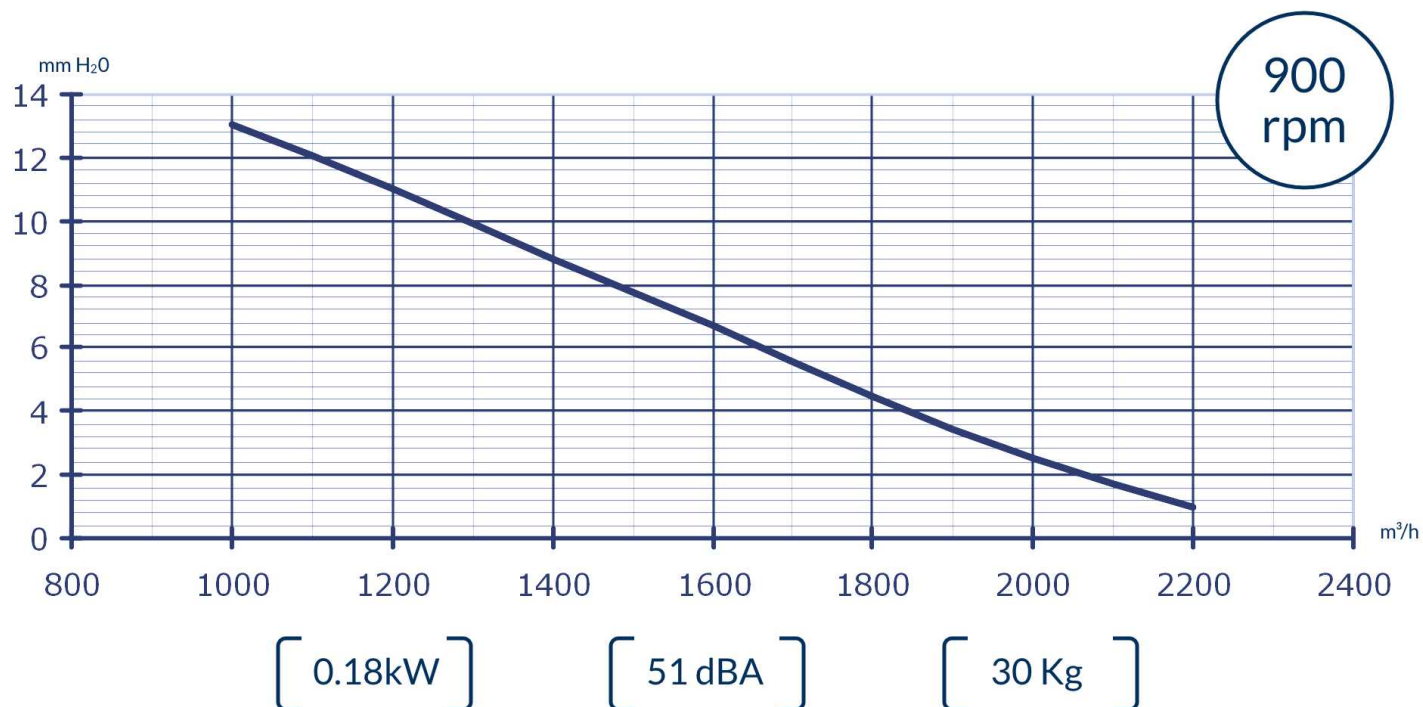
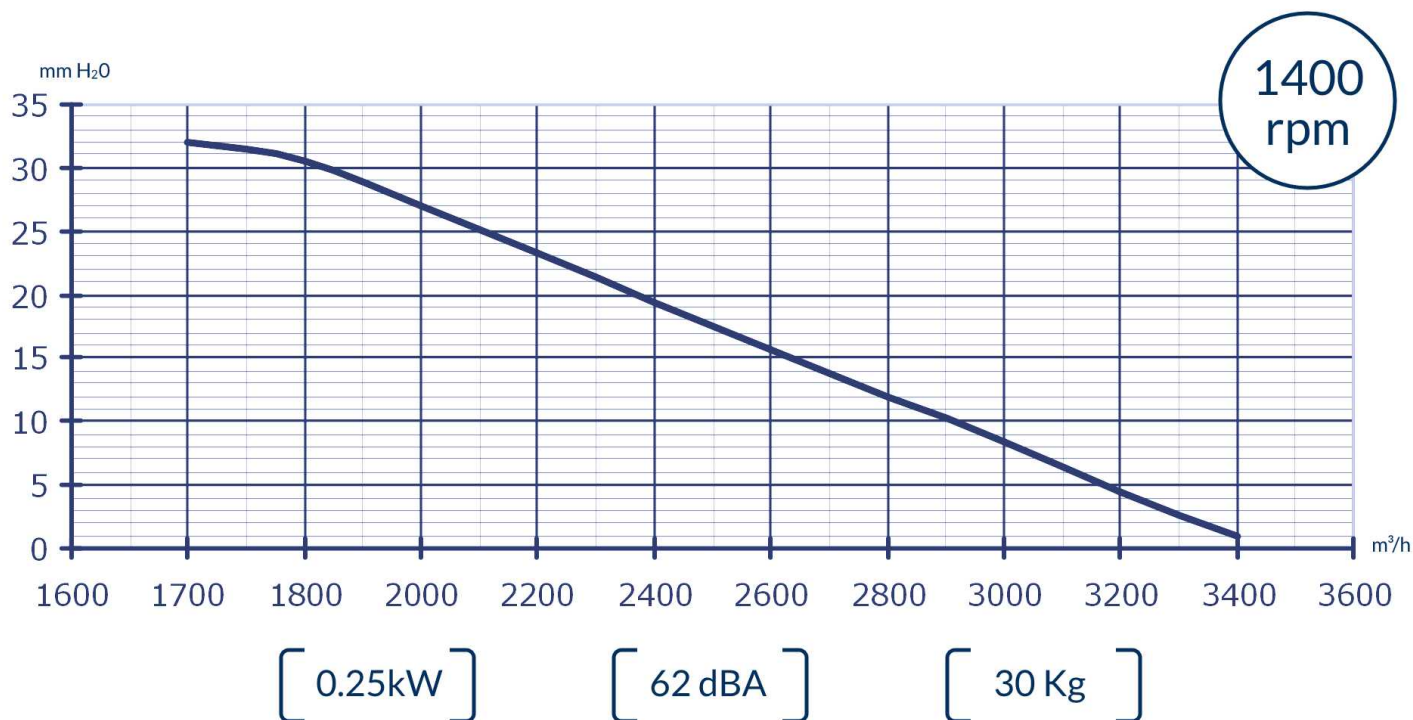

Ventilmotor s.r.l. a socio unico

Uffici e Stabilimento: Via Piaggio, 74 - 20037 - Paderno Dugnano (MI) **Sede Legale:** Via G. Pogliani, 34 - Paderno Dugnano (MI)

Tel: +39 02.9101051 / +39 02.99041382 **Fax:** +39 02.9103661 **Web:** info@ventilmotor.com - www.ventilmotor.com

Capitale Sociale € 10400.00 i.v. - REA 1519030 - N° Registro Imprese MI 53691 - Partita IVA 02632870966



Certificate n° 10-Q-10177-TIC



[ET 37]

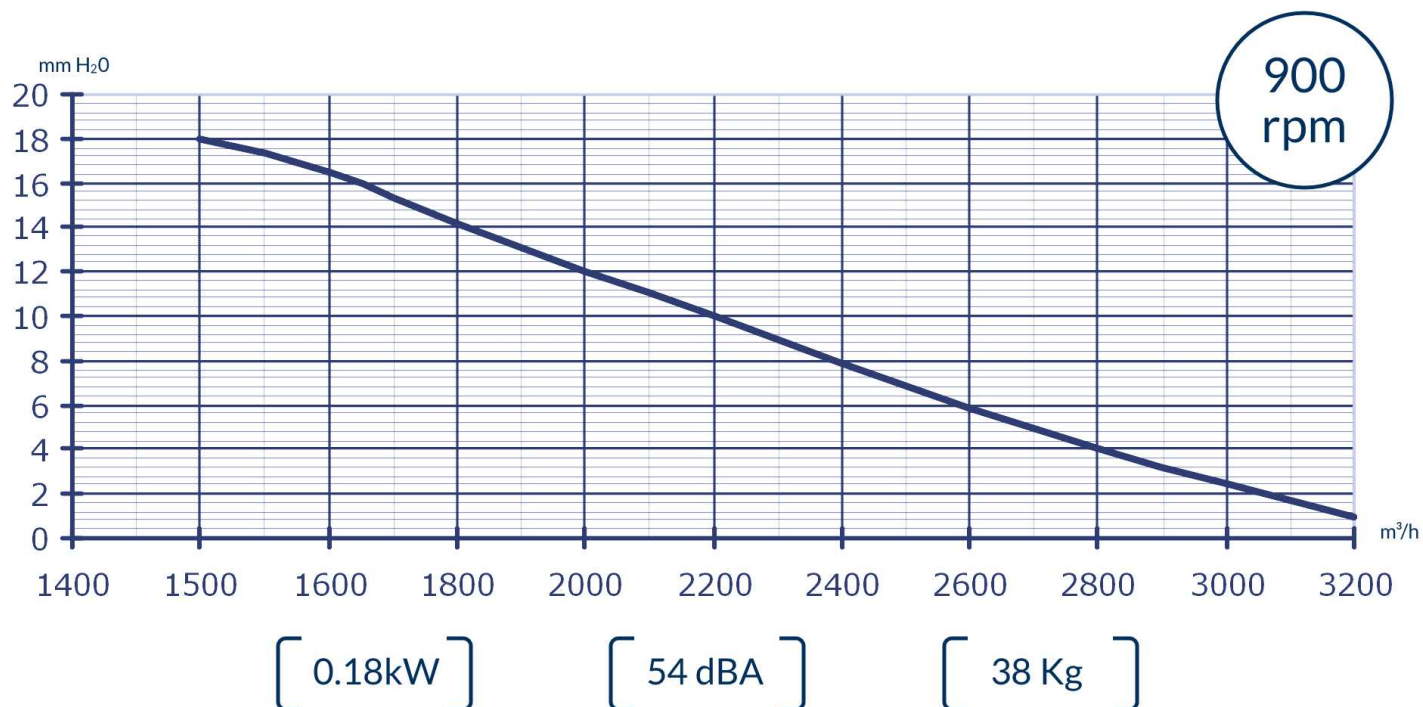
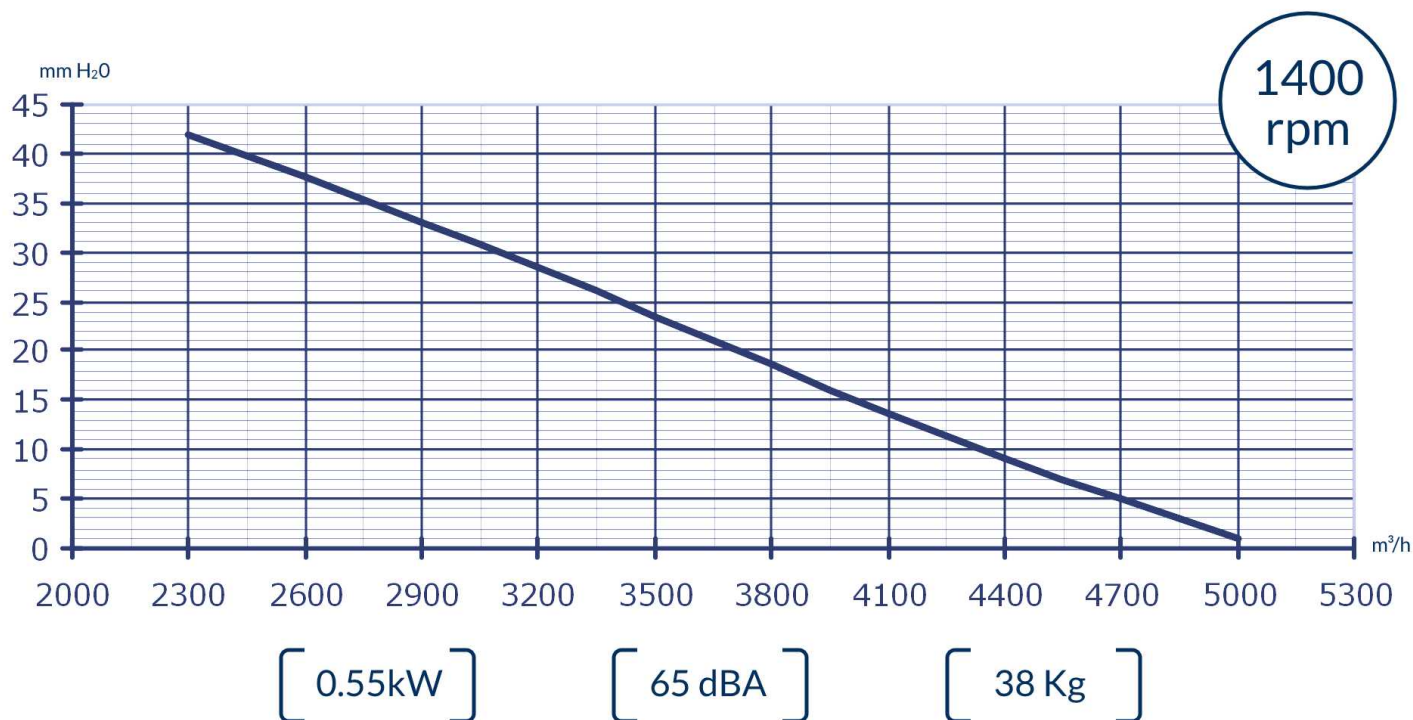

Ventilmotor s.r.l. a socio unico

Uffici e Stabilimento: Via Piaggio, 74 - 20037 - Paderno Dugnano (MI) Sede Legale: Via G. Pogliani, 34 - Paderno Dugnano (MI)

Tel: +39 02.9101051 / +39 02.99041382 Fax: +39 02.9103661 Web: info@ventilmotor.com - www.ventilmotor.com

Capitale Sociale € 10400.00 i.v. - REA 1519030 - N° Registro Imprese MI 53691 - Partita IVA 02632870966



Certificate n° 10-Q-10177-TIC



[ET 42]

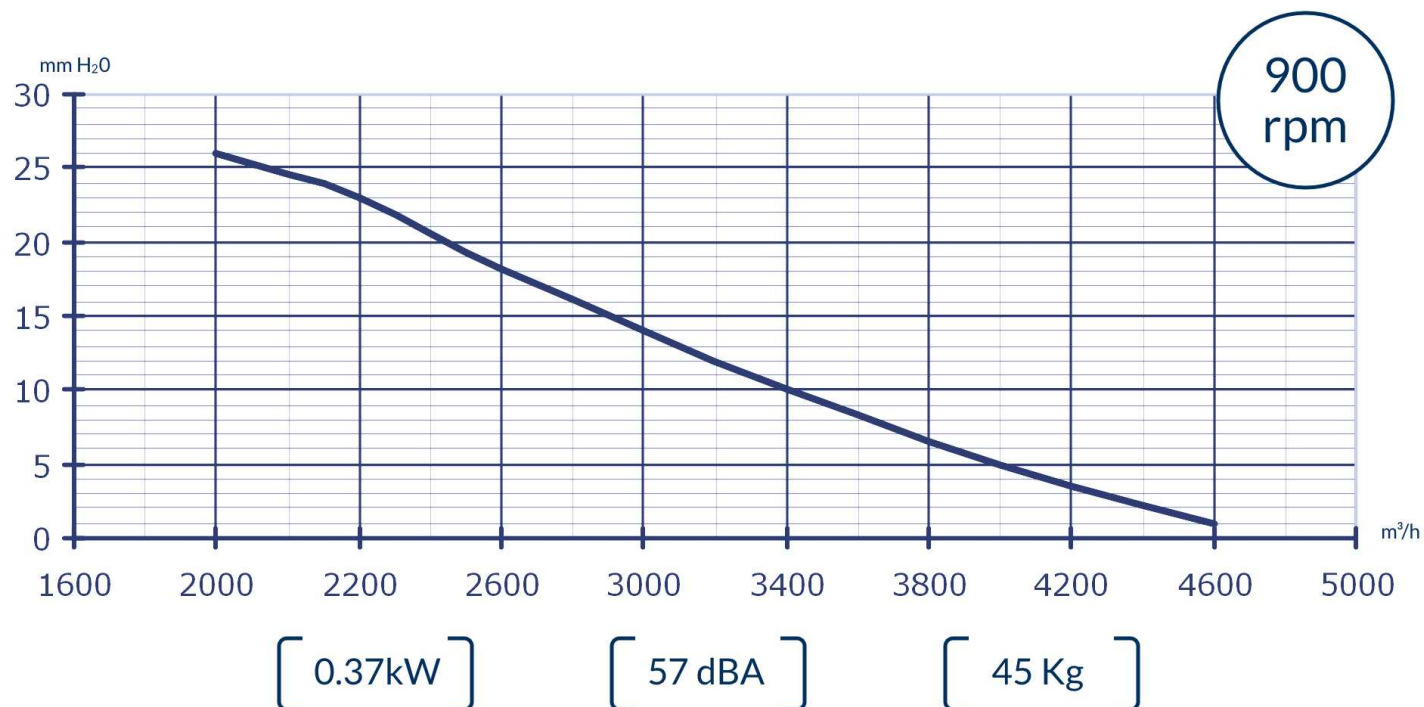
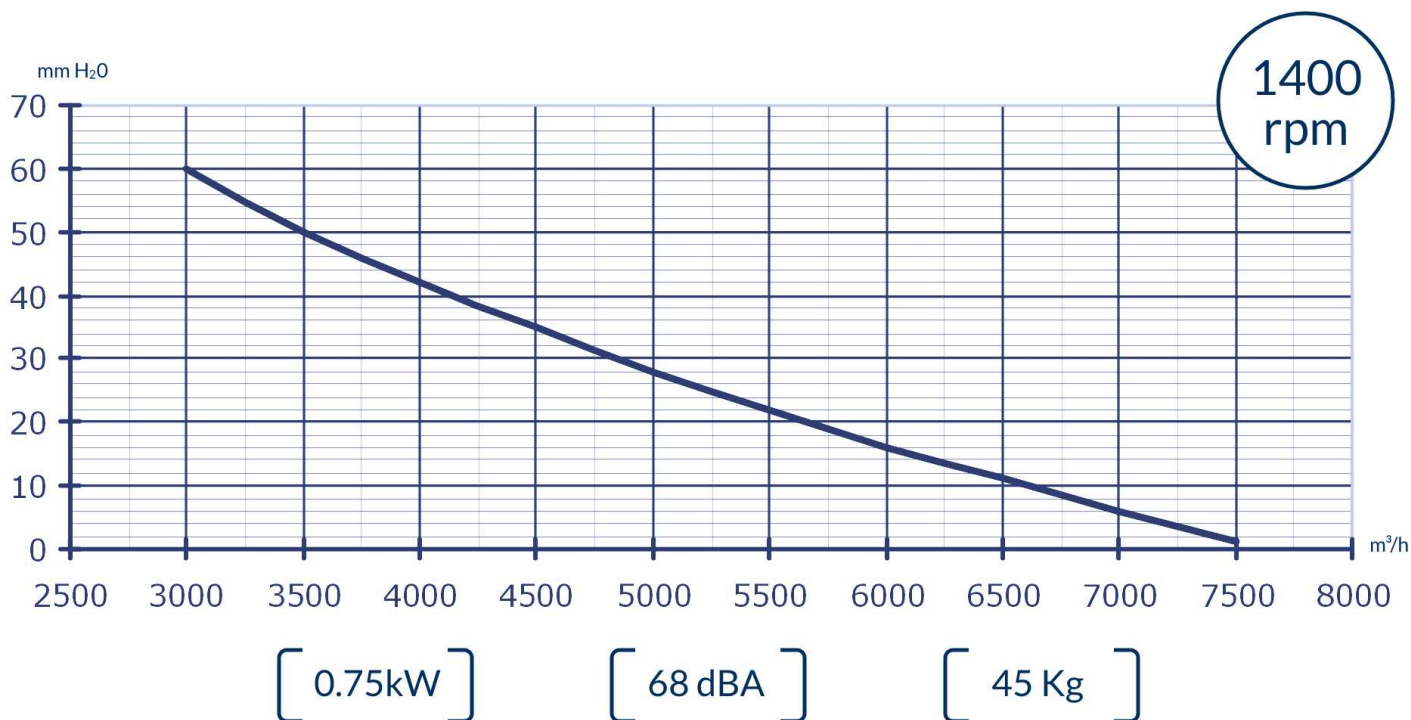

Ventilmotor s.r.l. a socio unico

Uffici e Stabilimento: Via Piaggio, 74 - 20037 - Paderno Dugnano (MI) **Sede Legale:** Via G. Pogliani, 34 - Paderno Dugnano (MI)

Tel: +39 02.9101051 / +39 02.99041382 **Fax:** +39 02.9103661 **Web:** info@ventilmotor.com - www.ventilmotor.com

Capitale Sociale € 10400.00 i.v. - REA 1519030 - N° Registro Imprese MI 53691 - Partita IVA 02632870966



Certificate n° 10-Q-10177-TIC



[ET 47]

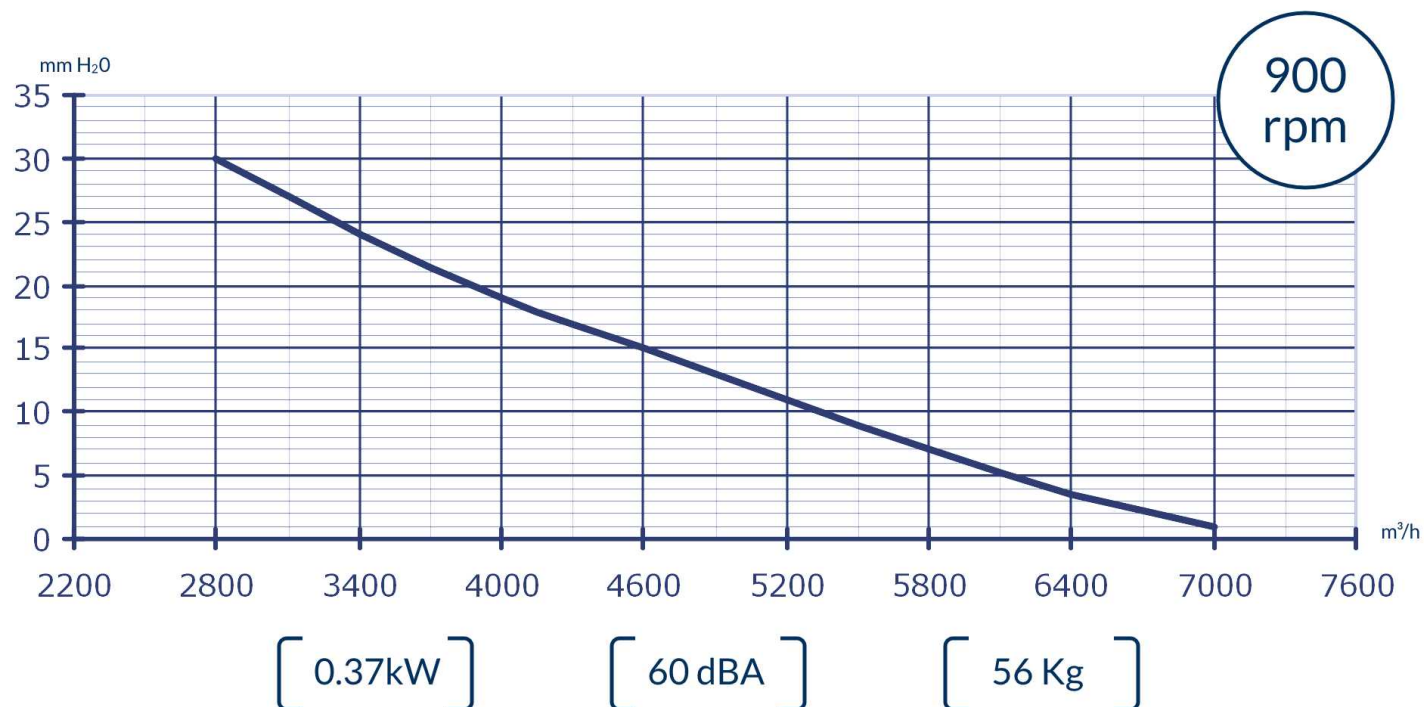
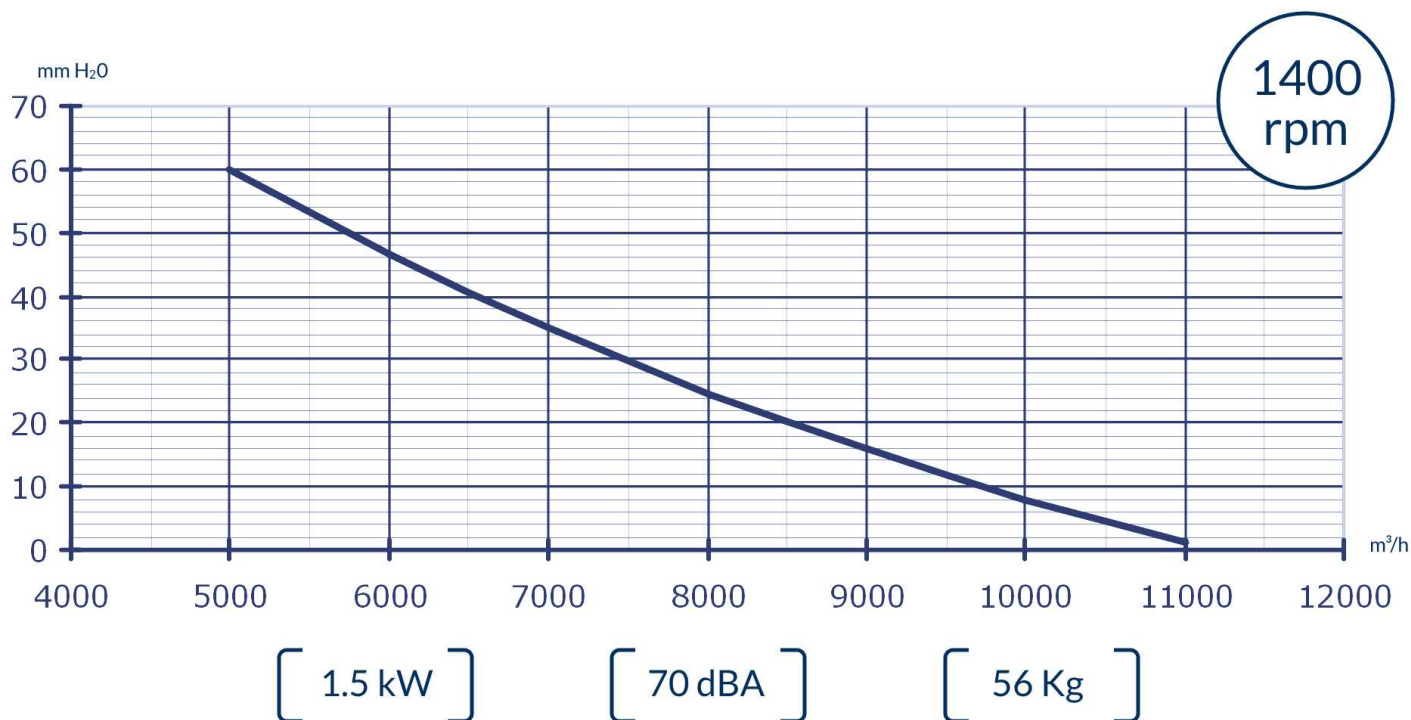

Ventilmotor s.r.l. a socio unico

Uffici e Stabilimento: Via Piaggio, 74 - 20037 - Paderno Dugnano (MI) **Sede Legale:** Via G. Pogliani, 34 - Paderno Dugnano (MI)

Tel: +39 02.9101051 / +39 02.99041382 **Fax:** +39 02.9103661 **Web:** info@ventilmotor.com - www.ventilmotor.com

Capitale Sociale € 10400.00 i.v. - REA 1519030 - N° Registro Imprese MI 53691 - Partita IVA 02632870966



Certificate n° 10-Q-10177-TIC



[ET 52]

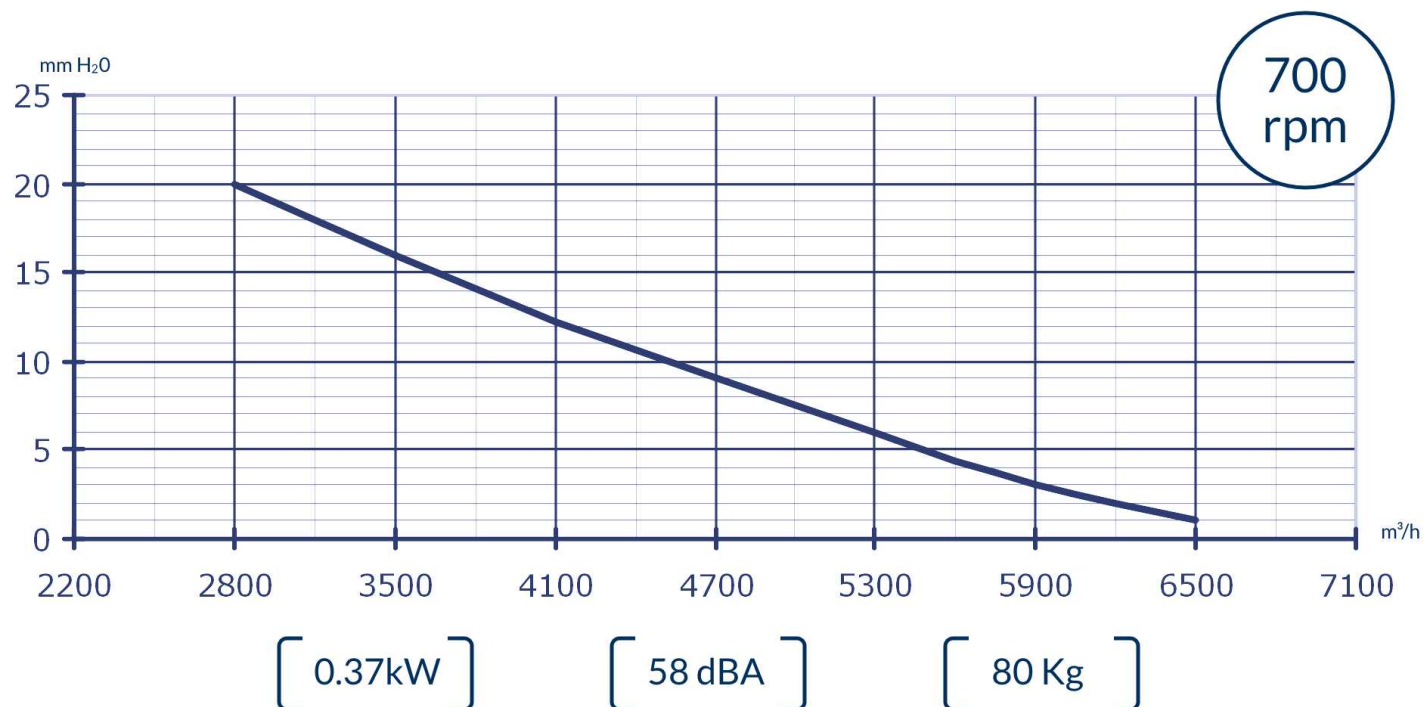
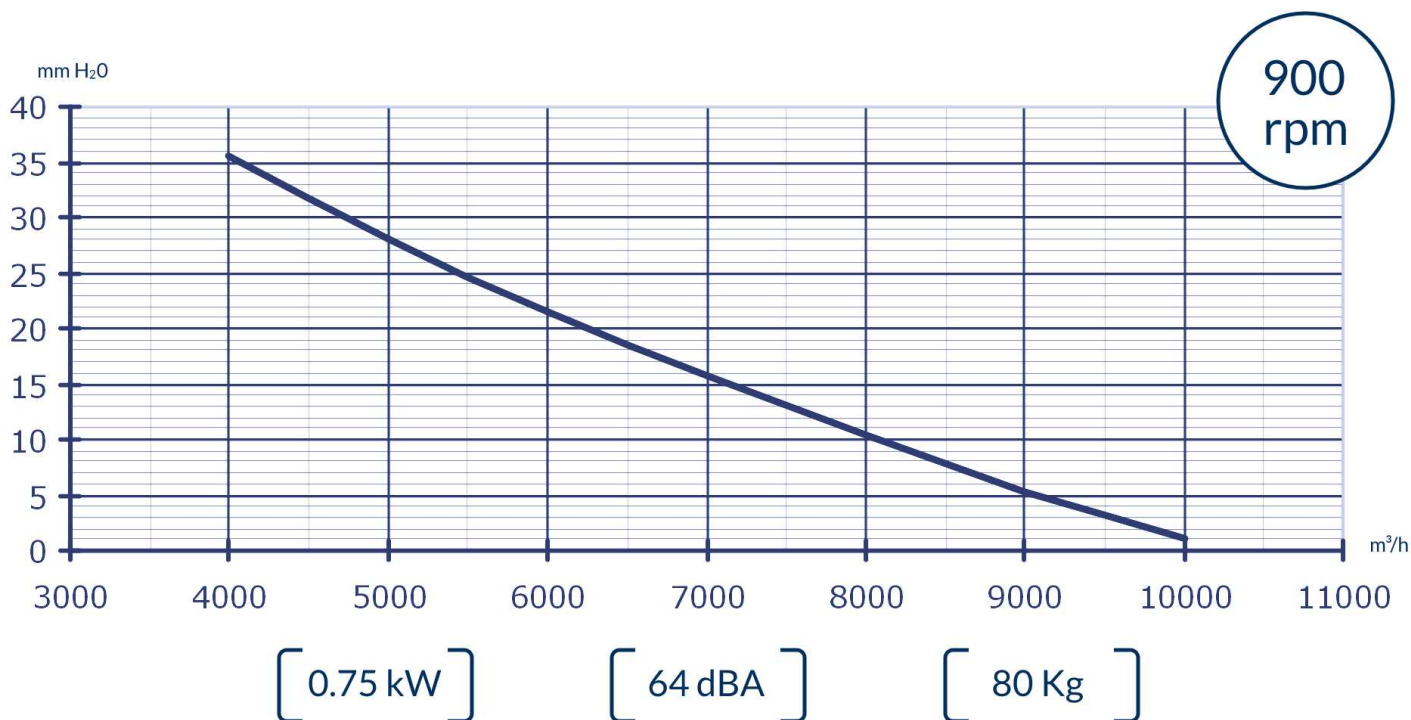

Ventilmotor s.r.l. a socio unico

Uffici e Stabilimento: Via Piaggio, 74 - 20037 - Paderno Dugnano (MI) **Sede Legale:** Via G. Pogliani, 34 - Paderno Dugnano (MI)

Tel: +39 02.9101051 / +39 02.99041382 **Fax:** +39 02.9103661 **Web:** info@ventilmotor.com - www.ventilmotor.com

Capitale Sociale € 10400.00 i.v. - REA 1519030 - N° Registro Imprese MI 53691 - Partita IVA 02632870966



Certificate n° 10-Q-10177-TIC



[ET 57]

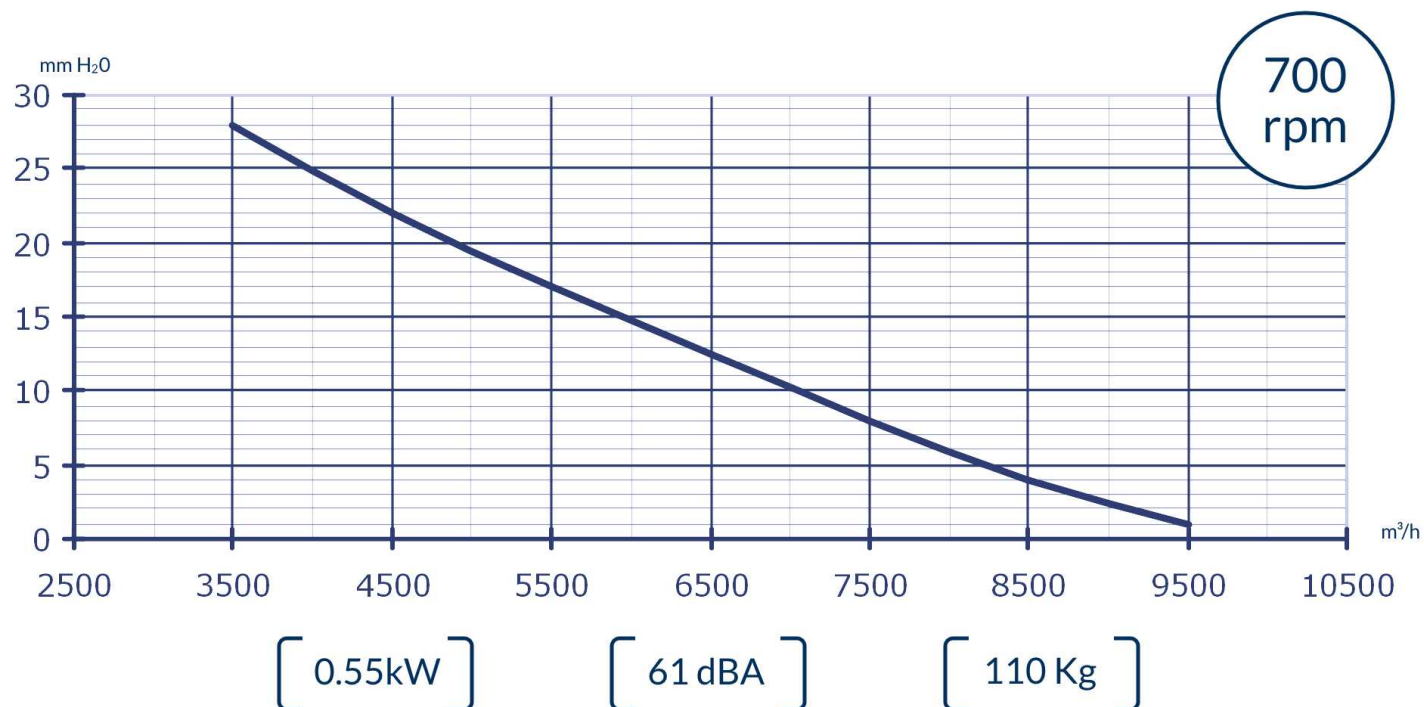
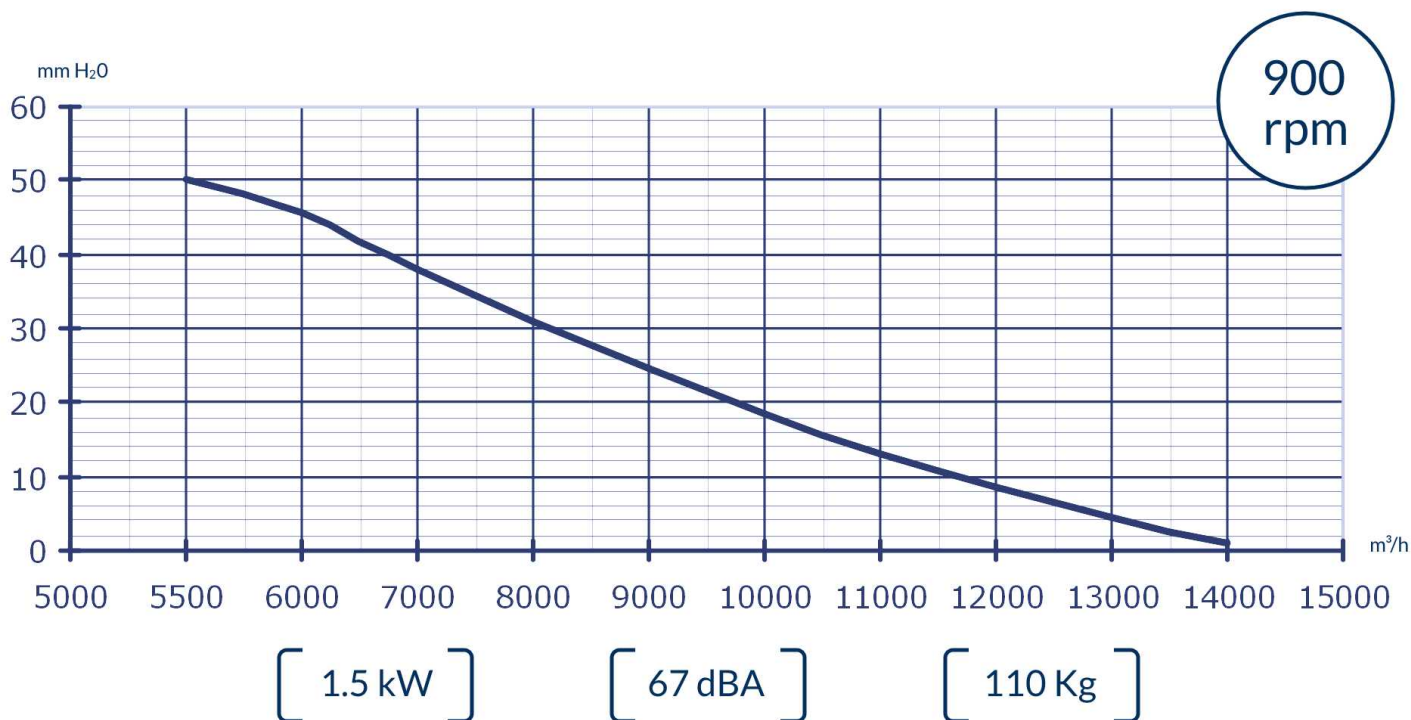

Ventilmotor s.r.l. a socio unico

Uffici e Stabilimento: Via Piaggio, 74 - 20037 - Paderno Dugnano (MI) **Sede Legale:** Via G. Pogliani, 34 - Paderno Dugnano (MI)

Tel: +39 02.9101051 / +39 02.99041382 **Fax:** +39 02.9103661 **Web:** info@ventilmotor.com - www.ventilmotor.com

Capitale Sociale € 10400.00 i.v. - REA 1519030 - N° Registro Imprese MI 53691 - Partita IVA 02632870966



Certificate n° 10-Q-10177-TIC



[ET 62]

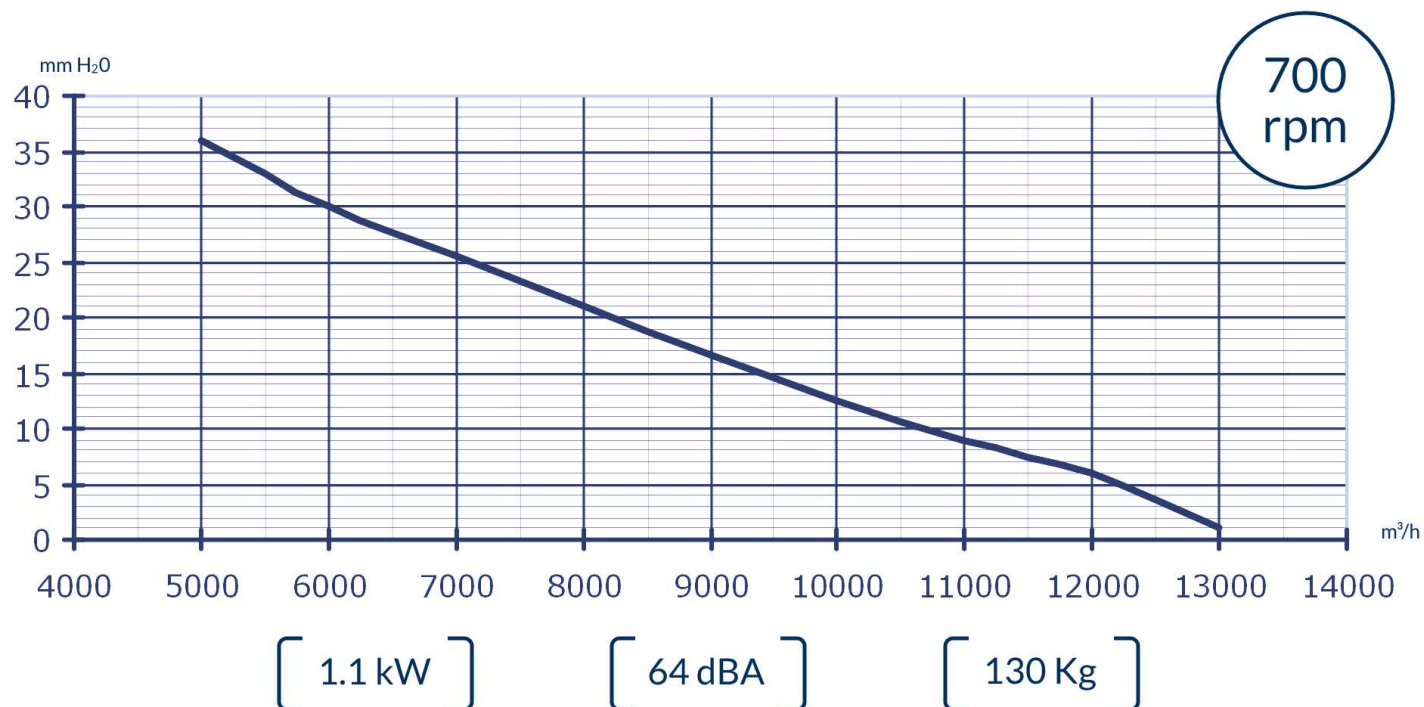
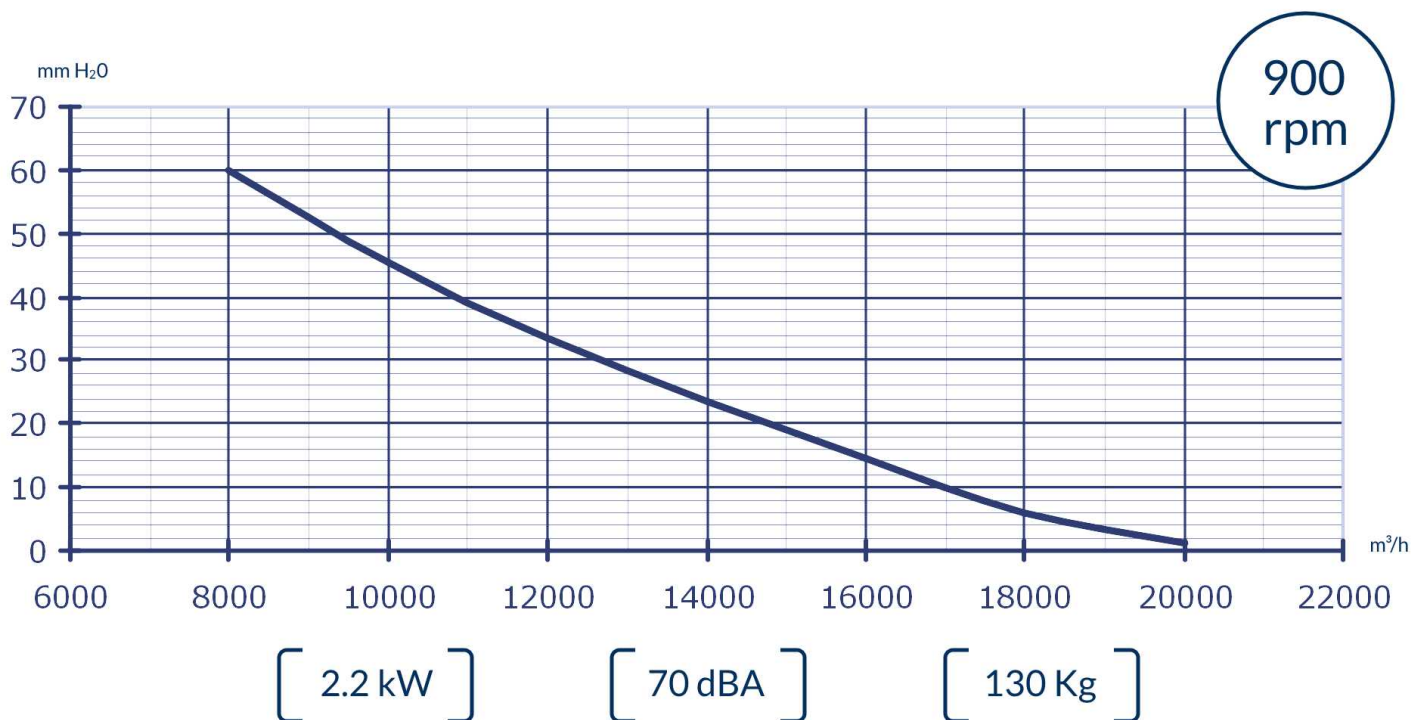

Ventilmotor s.r.l. a socio unico

Uffici e Stabilimento: Via Piaggio, 74 - 20037 - Paderno Dugnano (MI) **Sede Legale:** Via G. Pogliani, 34 - Paderno Dugnano (MI)

Tel: +39 02.9101051 / +39 02.99041382 **Fax:** +39 02.9103661 **Web:** info@ventilmotor.com - www.ventilmotor.com

Capitale Sociale € 10400.00 i.v. - REA 1519030 - N° Registro Imprese MI 53691 - Partita IVA 02632870966



Certificate n° 10-Q-10177-TIC