

Gli elettroventilatori a torrino SERIE ETE sono particolarmente adatti per la grande ventilazione industriale, allevamenti, stalle, per ricambi aria o estrazione fumi. Base di appoggio in acciaio zincato. Cupola in vetroresina.

Questi estrattori, la cui serie è composta da 9 modelli, sono ideali in caso si necessiti di grandi portate d'aria con pressioni relativamente basse e temperatura ambiente massima di 60°C

**Ventilmotor s.r.l. a socio unico**

**Uffici e Stabilimento:** Via Piaggio, 74 - 20037 - Paderno Dugnano (MI) **Sede Legale:** Via G. Pogliani, 34 - Paderno Dugnano (MI)

**Tel:** +39 02.9101051 / +39 02.99041382 **Fax:** +39 02.9103661 **Web:** [info@ventilmotor.com](mailto:info@ventilmotor.com) - [www.ventilmotor.com](http://www.ventilmotor.com)

Capitale Sociale € 10400.00 i.v. - REA 1519030 - N° Registro Imprese MI 53691 - Partita IVA 02632870966



# SERIE ETE

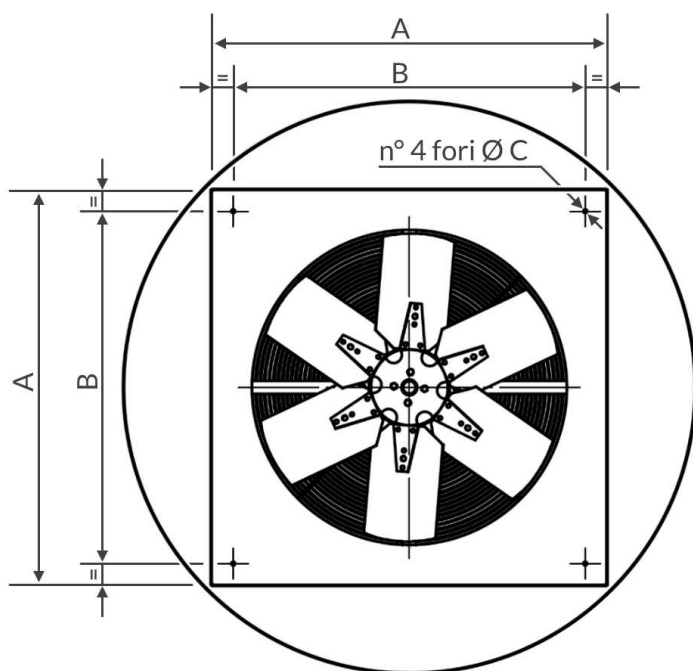
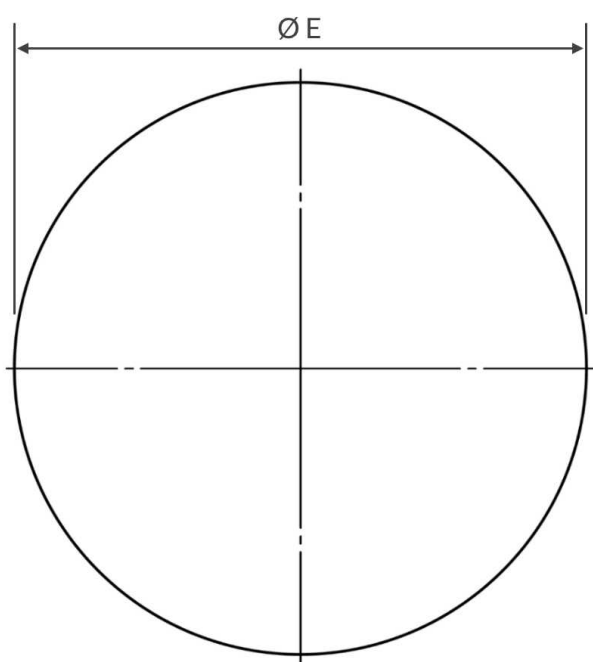
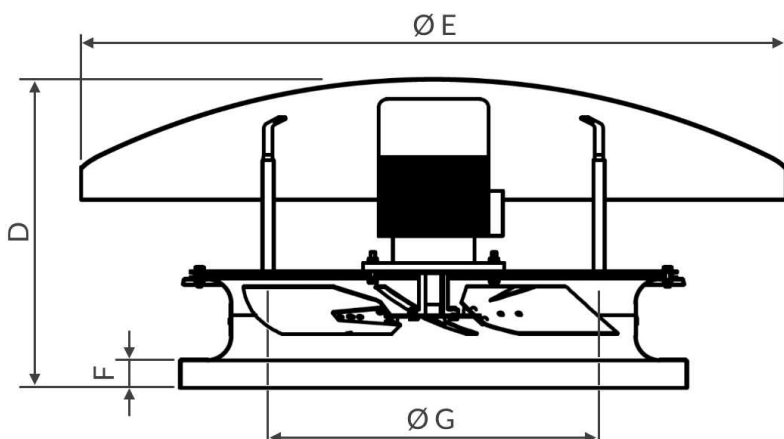

MODELLO	A	B	C	D	E	F	G
ETE 260	350	300	8,5	350	560	15	265
ETE 310	400	350	8,5	400	800	15	315
ETE 360	450	400	8,5	440	800	15	365
ETE 410	500	450	8,5	440	800	15	420
ETE 510	600	550	8,5	520	1000	15	520
ETE 610	730	680	8,5	460	1250	15	620
ETE 710	900	800	8,5	470	1250	65	715
ETE 760	900	800	8,5	470	1250	65	780
ETE 910	1250	1150	8,5	650	1500	65	930

**Ventilmotor s.r.l. a socio unico**

**Uffici e Stabilimento:** Via Piaggio, 74 - 20037 - Paderno Dugnano (MI) **Sede Legale:** Via G. Pogliani, 34 - Paderno Dugnano (MI)

**Tel:** +39 02.9101051 / +39 02.99041382 **Fax:** +39 02.9103661 **Web:** info@ventilmotor.com - www.ventilmotor.com

Capitale Sociale € 10400.00 i.v. - REA 1519030 - N° Registro Imprese MI 53691 - Partita IVA 02632870966



Certificate n° 10-Q-10177-TIC



# [ ETE 260 ]

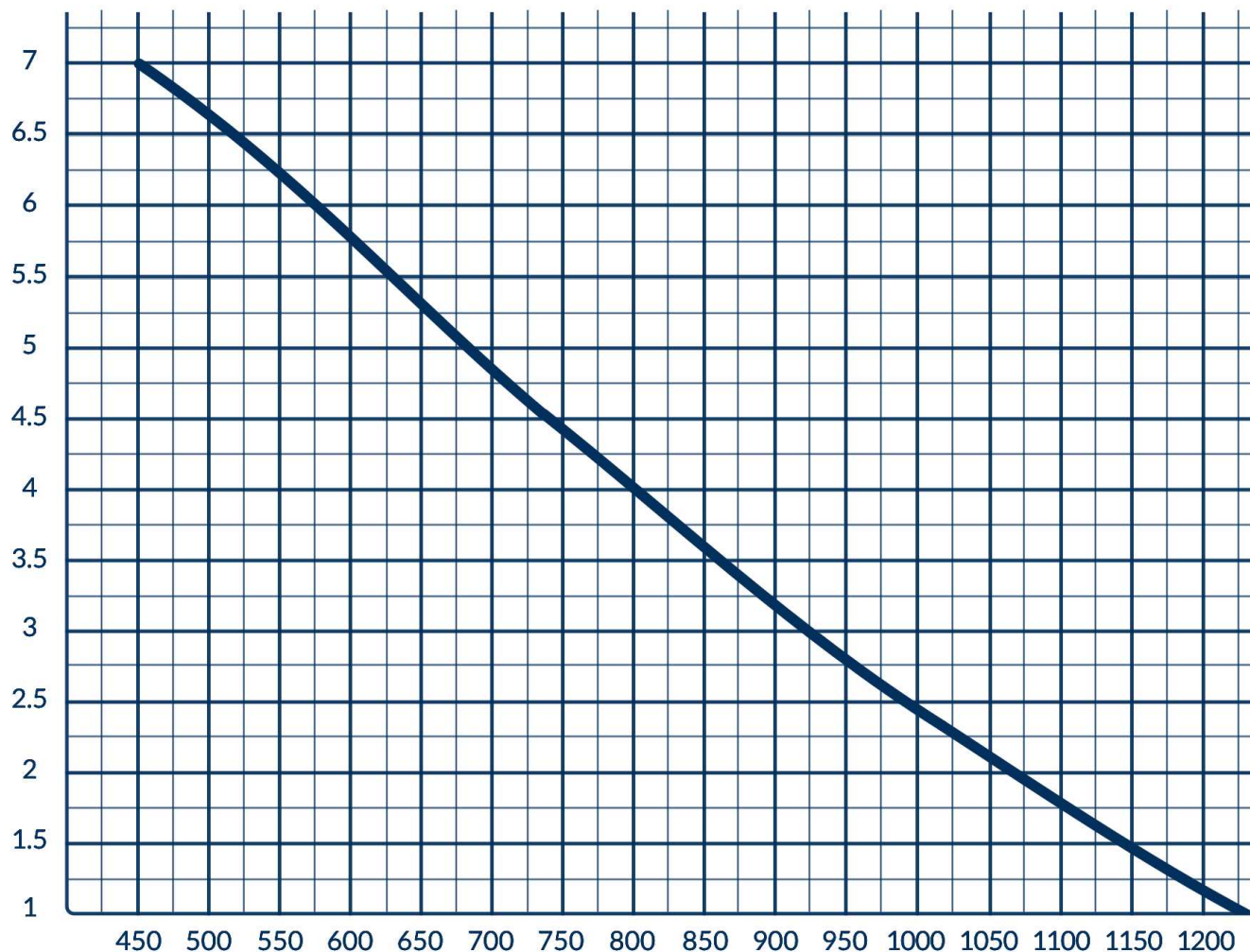

1400  
rpm

0.12  
kW

**Ventilmotor s.r.l. a socio unico**

**Uffici e Stabilimento:** Via Piaggio, 74 - 20037 - Paderno Dugnano (MI) **Sede Legale:** Via G. Pogliani, 34 - Paderno Dugnano (MI)

**Tel:** +39 02.9101051 / +39 02.99041382 **Fax:** +39 02.9103661 **Web:** info@ventilmotor.com - www.ventilmotor.com

Capitale Sociale € 10400.00 i.v. - REA 1519030 - N° Registro Imprese MI 53691 - Partita IVA 02632870966



Certificate n° 10-Q-10177-TIC



# [ ETE 310 ]

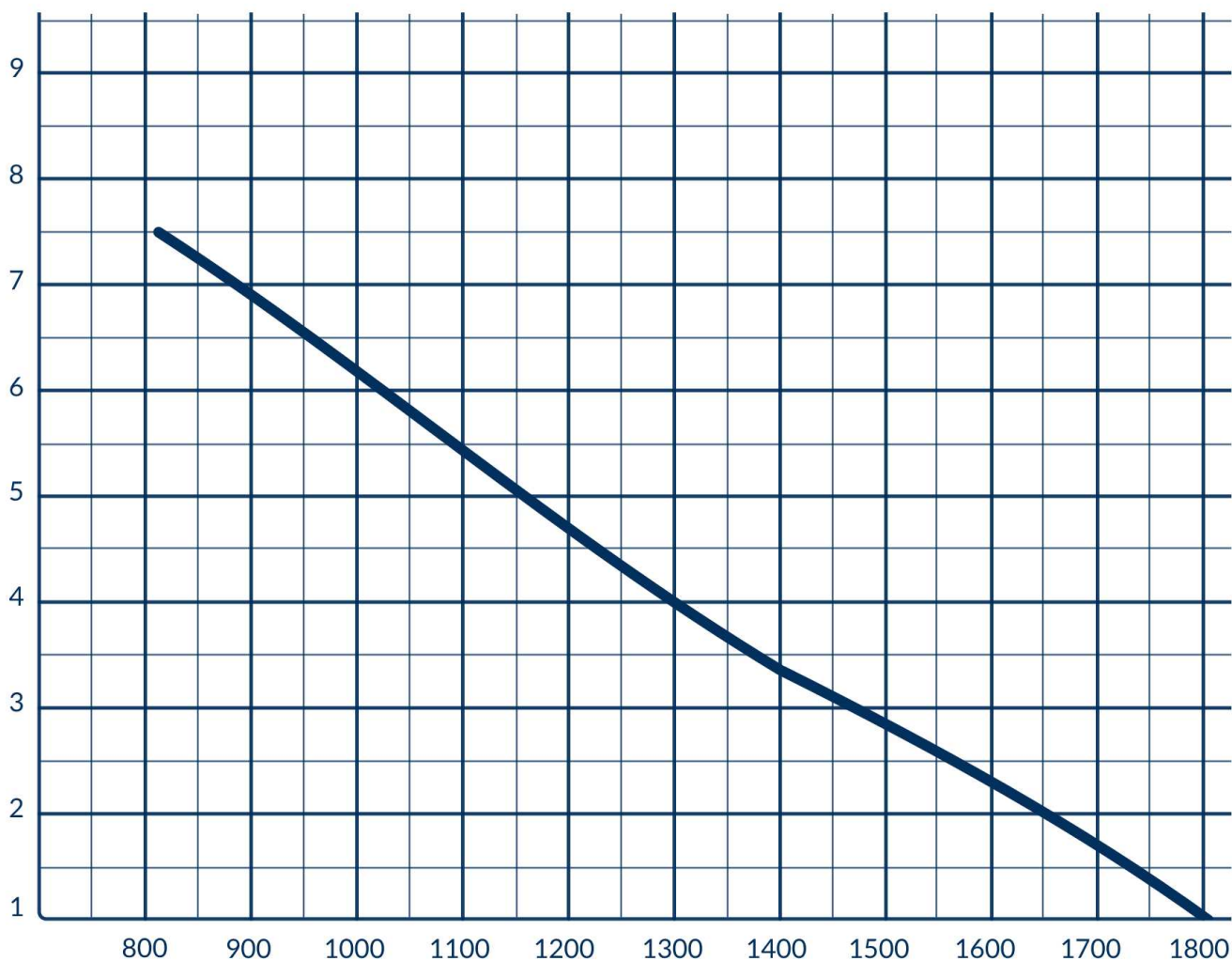

1400  
rpm

0.12  
kW

## Ventilmotor s.r.l. a socio unico

**Uffici e Stabilimento:** Via Piaggio, 74 - 20037 - Paderno Dugnano (MI) **Sede Legale:** Via G. Pogliani, 34 - Paderno Dugnano (MI)

**Tel:** +39 02.9101051 / +39 02.99041382 **Fax:** +39 02.9103661 **Web:** info@ventilmotor.com - www.ventilmotor.com

Capitale Sociale € 10400.00 i.v. - REA 1519030 - N° Registro Imprese MI 53691 - Partita IVA 02632870966



Certificate n° 10-Q-10177-TIC





# [ ETE 360 ]

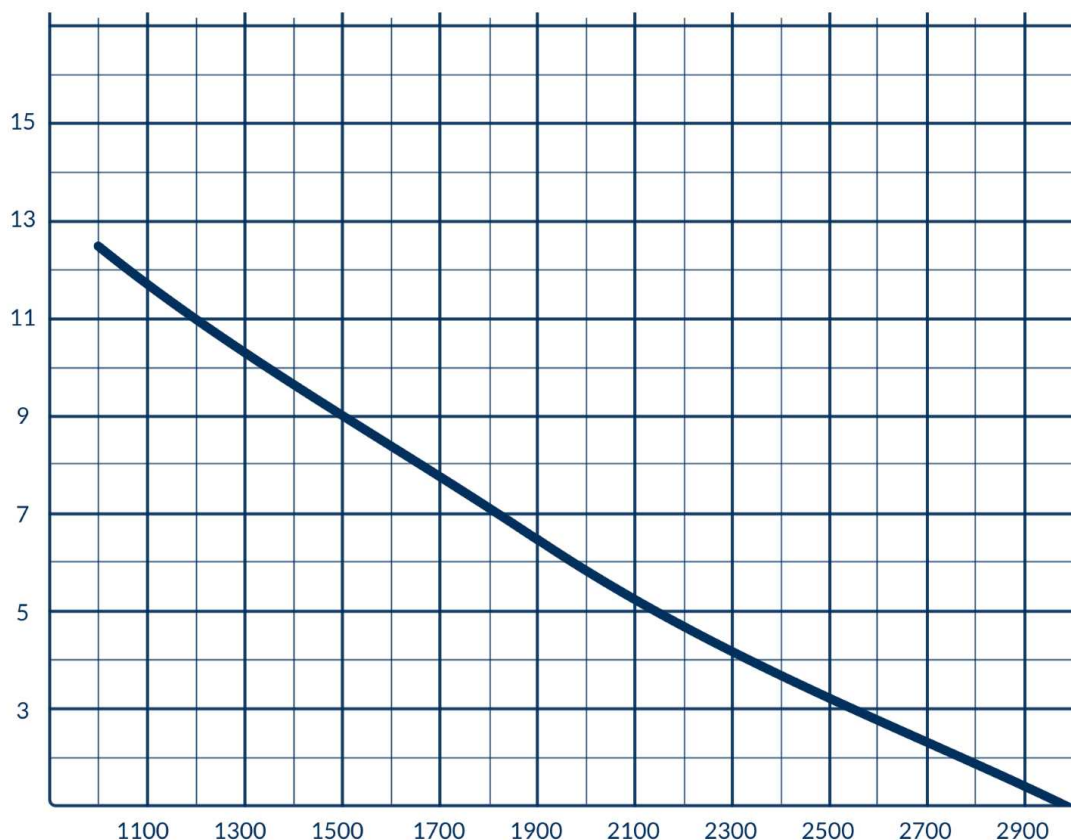

1400  
rpm

0.18  
kW

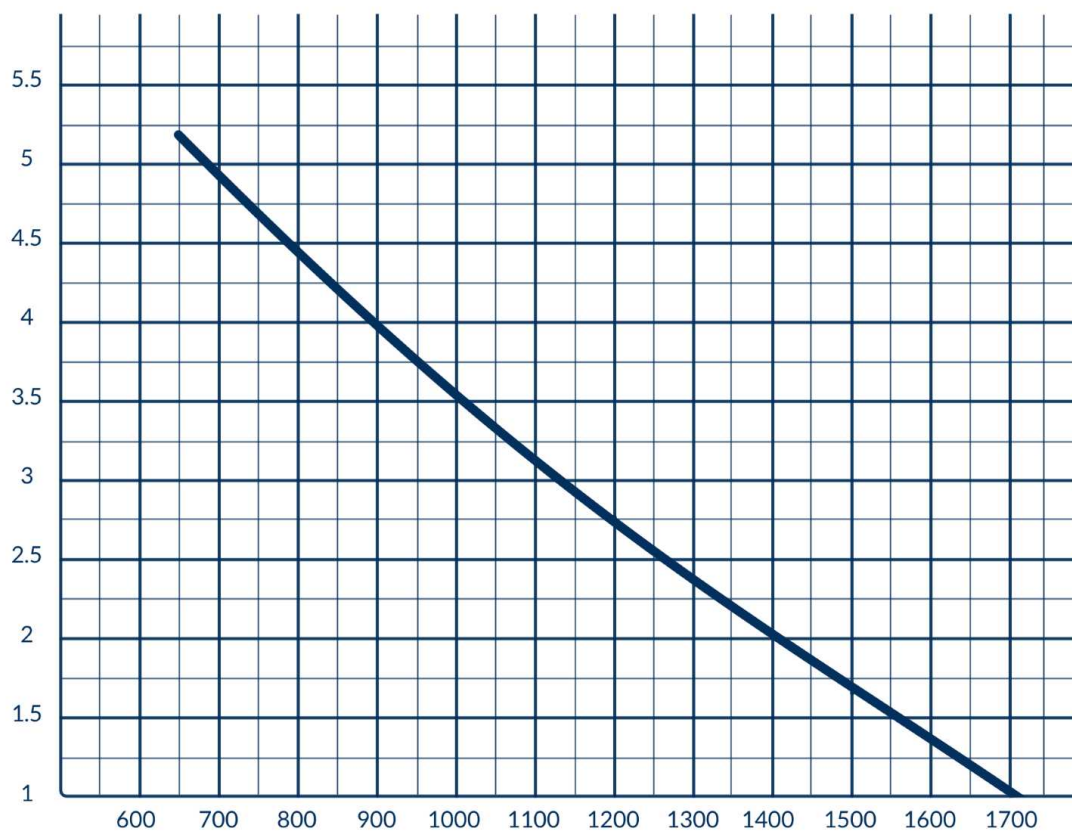

900  
rpm

0.18  
kW

## Ventilmotor s.r.l. a socio unico

**Uffici e Stabilimento:** Via Piaggio, 74 - 20037 - Paderno Dugnano (MI) **Sede Legale:** Via G. Pogliani, 34 - Paderno Dugnano (MI)

**Tel:** +39 02.9101051 / +39 02.99041382 **Fax:** +39 02.9103661 **Web:** info@ventilmotor.com - www.ventilmotor.com

Capitale Sociale € 10400.00 i.v. - REA 1519030 - N° Registro Imprese MI 53691 - Partita IVA 02632870966



Certificate n° 10-Q-10177-TIC



# [ ETE 410 ]

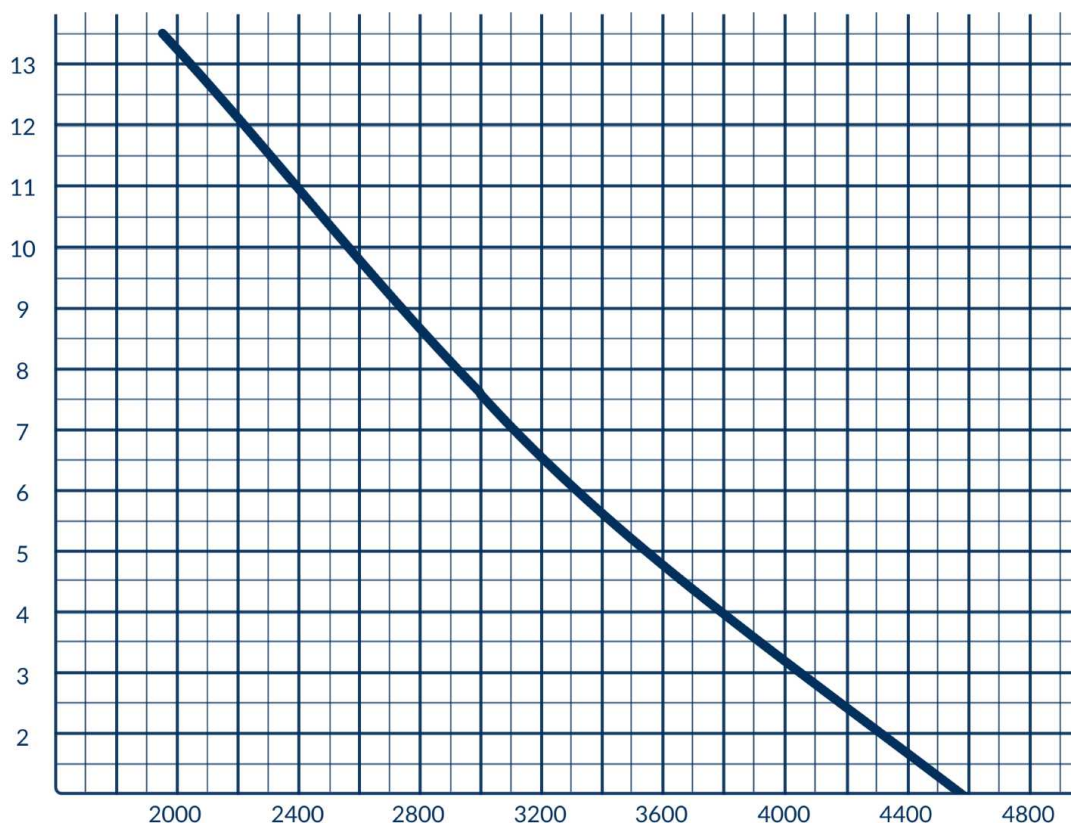

1400  
rpm

0.25  
kW

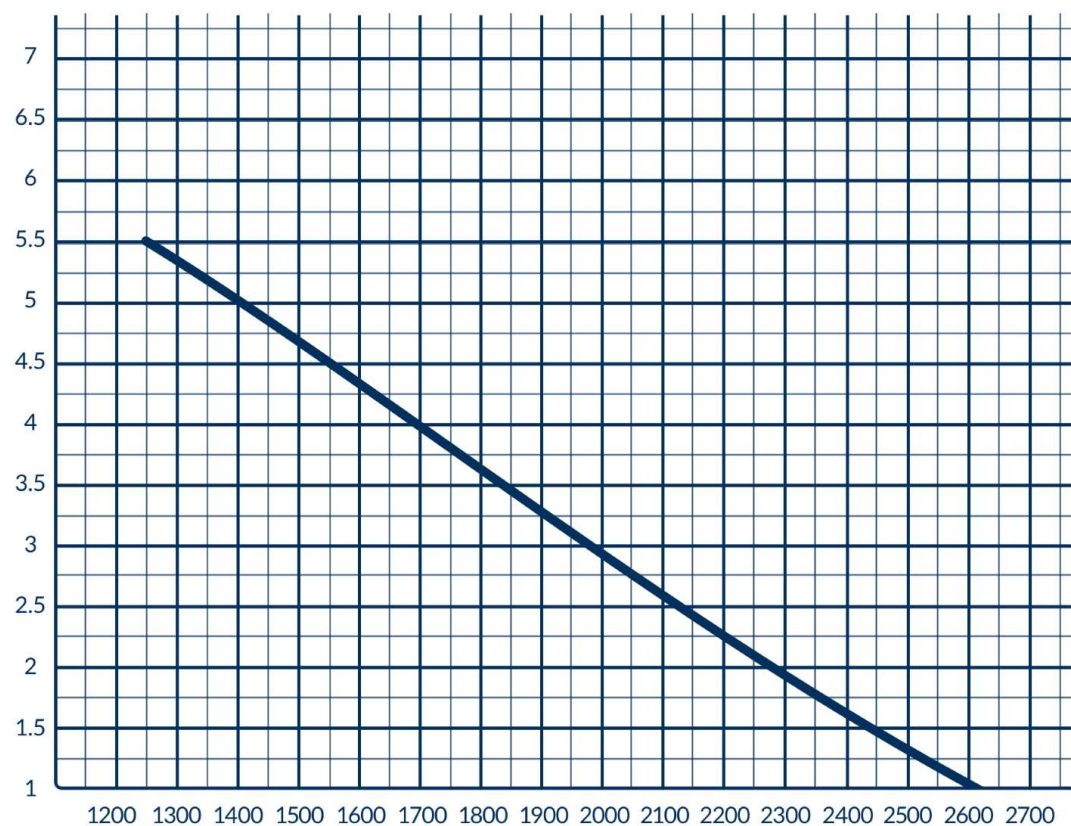

900  
rpm

0.18  
kW

## Ventilmotor s.r.l. a socio unico

**Uffici e Stabilimento:** Via Piaggio, 74 - 20037 - Paderno Dugnano (MI) **Sede Legale:** Via G. Pogliani, 34 - Paderno Dugnano (MI)

**Tel:** +39 02.9101051 / +39 02.99041382 **Fax:** +39 02.9103661 **Web:** info@ventilmotor.com - www.ventilmotor.com

Capitale Sociale € 10400.00 i.v. - REA 1519030 - N° Registro Imprese MI 53691 - Partita IVA 02632870966



Certificate n° 10-Q-10177-TIC



# [ ETE 510 ]

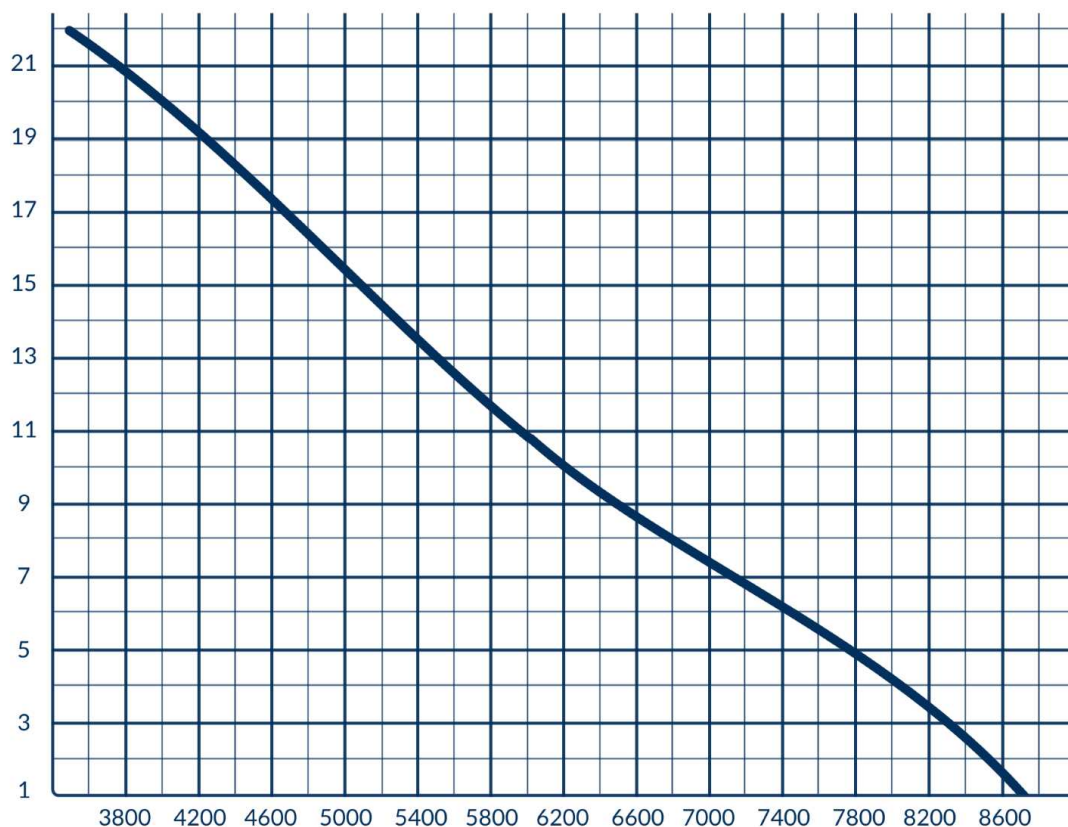

1400  
rpm

0.75  
kW

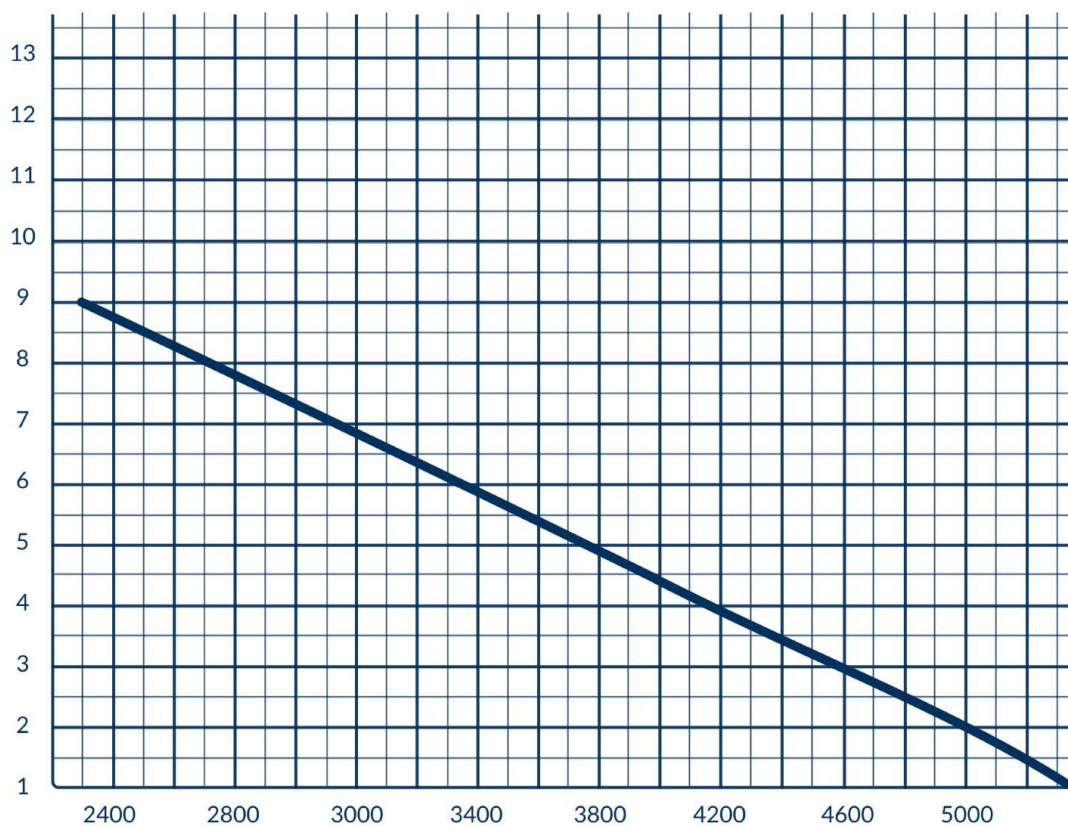

900  
rpm

0.25  
kW

## Ventilmotor s.r.l. a socio unico

**Uffici e Stabilimento:** Via Piaggio, 74 - 20037 - Paderno Dugnano (MI) **Sede Legale:** Via G. Pogliani, 34 - Paderno Dugnano (MI)

**Tel:** +39 02.9101051 / +39 02.99041382 **Fax:** +39 02.9103661 **Web:** info@ventilmotor.com - www.ventilmotor.com

Capitale Sociale € 10400.00 i.v. - REA 1519030 - N° Registro Imprese MI 53691 - Partita IVA 02632870966



Certificate n° 10-Q-10177-TIC





# [ ETE 610 ]

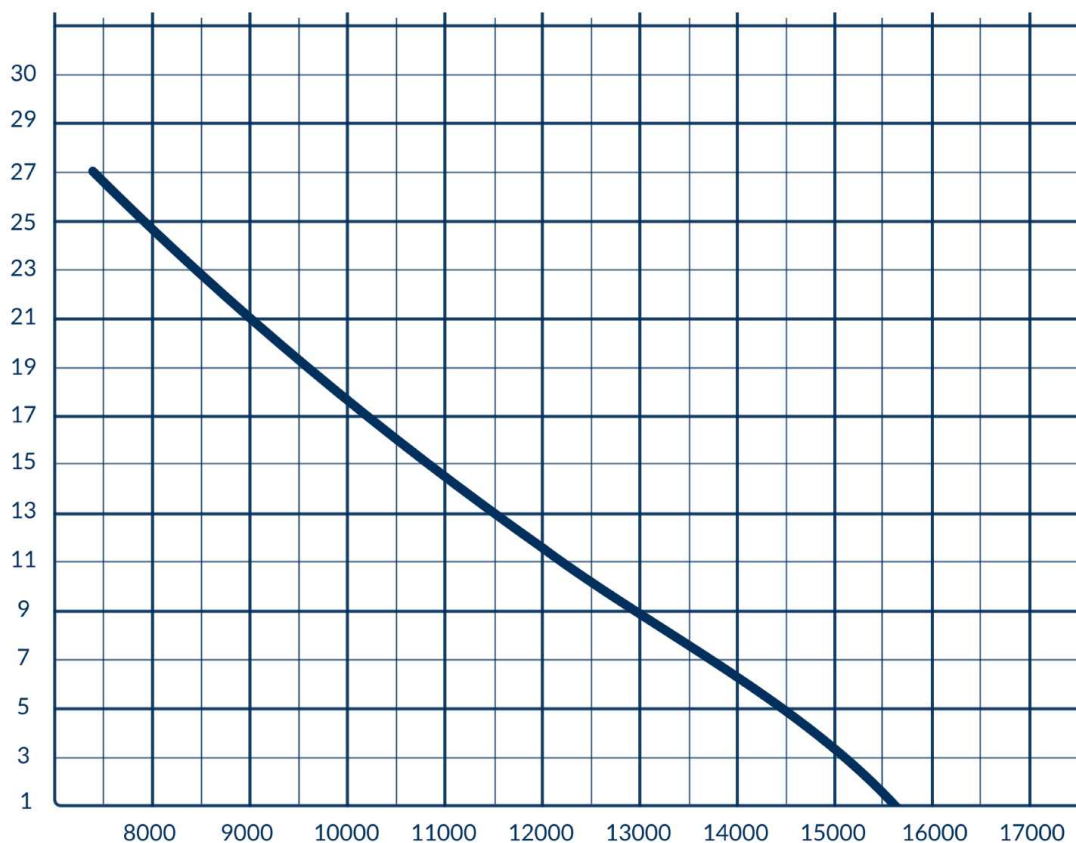

1400  
rpm

1.5  
kW

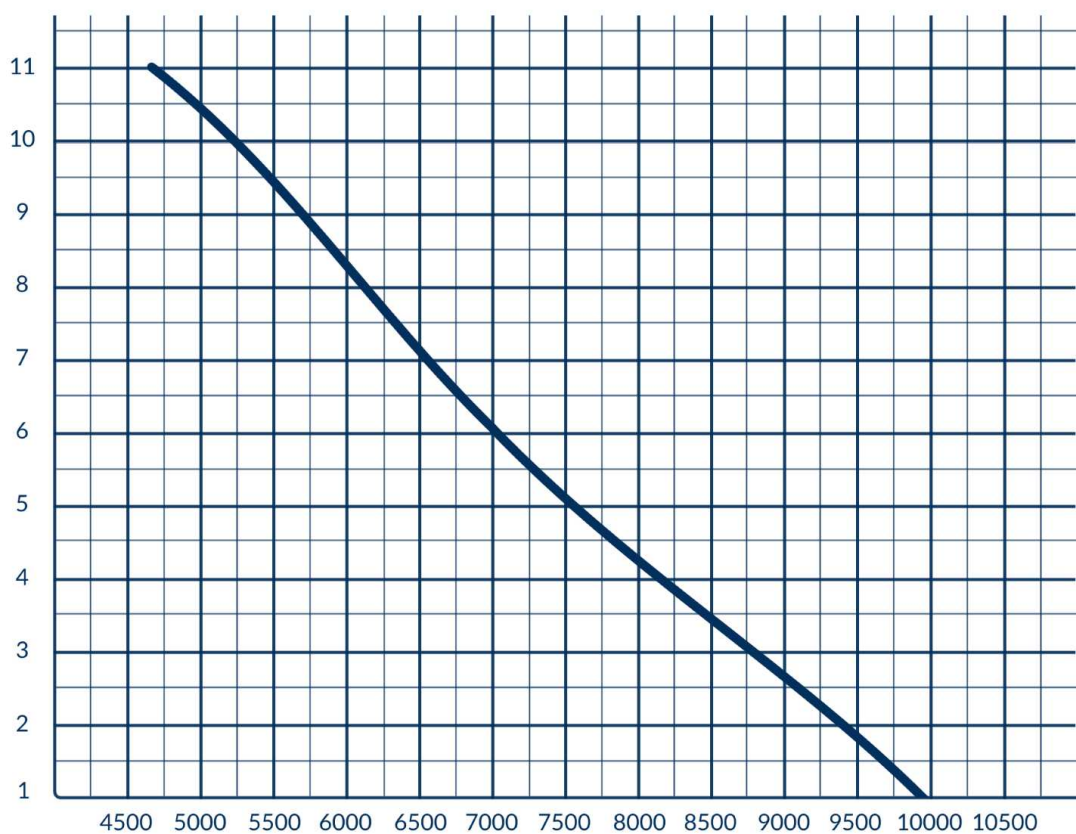

900  
rpm

0.55  
kW

## Ventilmotor s.r.l. a socio unico

**Uffici e Stabilimento:** Via Piaggio, 74 - 20037 - Paderno Dugnano (MI) **Sede Legale:** Via G. Pogliani, 34 - Paderno Dugnano (MI)

**Tel:** +39 02.9101051 / +39 02.99041382 **Fax:** +39 02.9103661 **Web:** info@ventilmotor.com - www.ventilmotor.com

Capitale Sociale € 10400.00 i.v. - REA 1519030 - N° Registro Imprese MI 53691 - Partita IVA 02632870966



Certificate n° 10-Q-10177-TIC





# [ ETE 710 ]

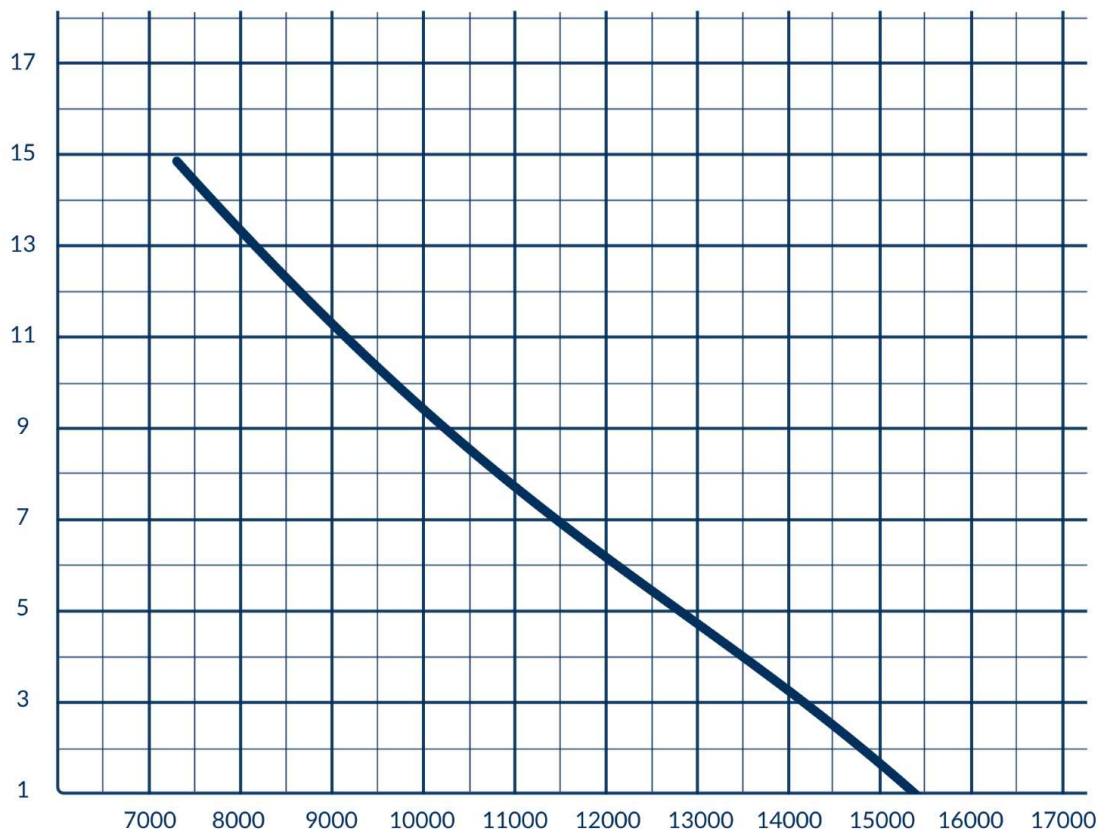

900  
rpm

1.1  
kW

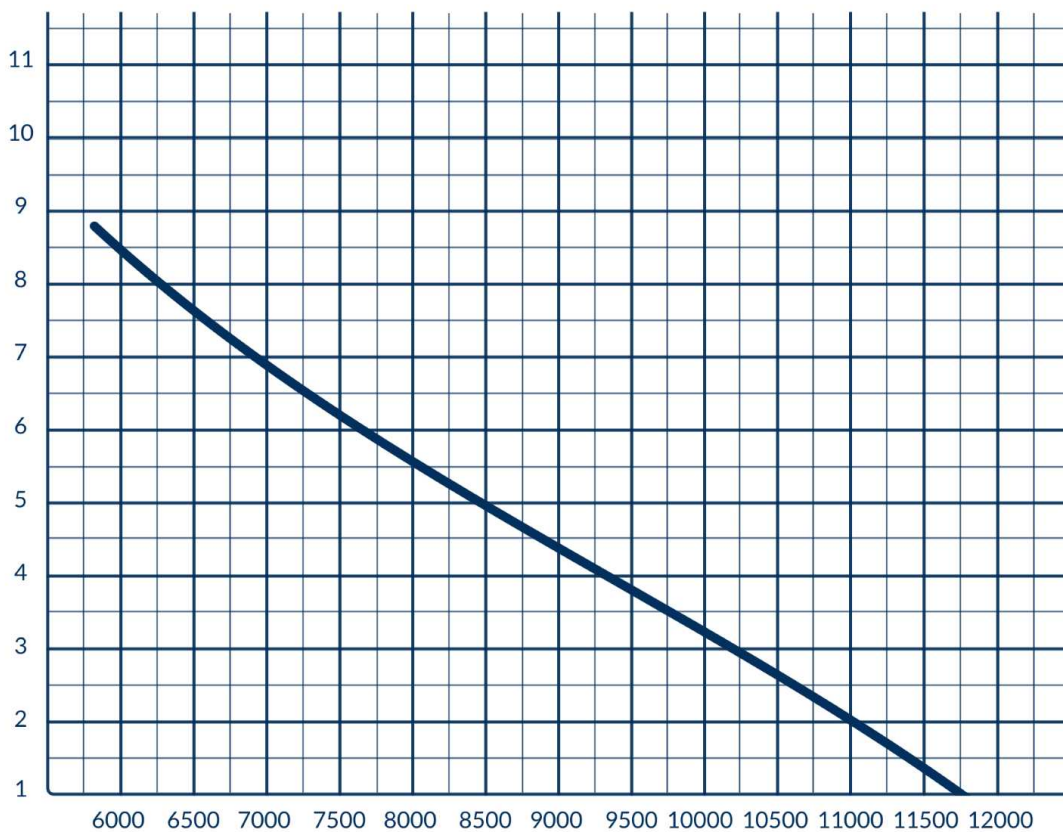

700  
rpm

0.75  
kW

## Ventilmotor s.r.l. a socio unico

**Uffici e Stabilimento:** Via Piaggio, 74 - 20037 - Paderno Dugnano (MI) **Sede Legale:** Via G. Pogliani, 34 - Paderno Dugnano (MI)

**Tel:** +39 02.9101051 / +39 02.99041382 **Fax:** +39 02.9103661 **Web:** info@ventilmotor.com - www.ventilmotor.com

Capitale Sociale € 10400.00 i.v. - REA 1519030 - N° Registro Imprese MI 53691 - Partita IVA 02632870966



Certificate n° 10-Q-10177-TIC



# [ ETE 760 ]

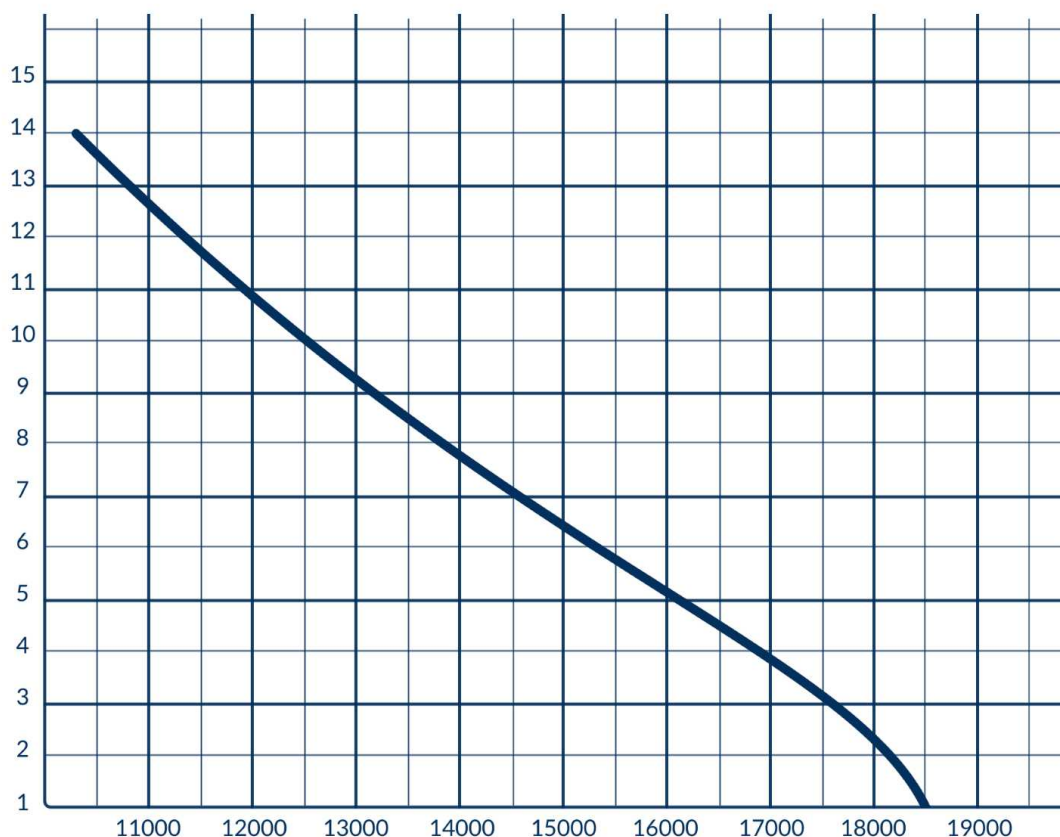

900  
rpm

1.5  
kW

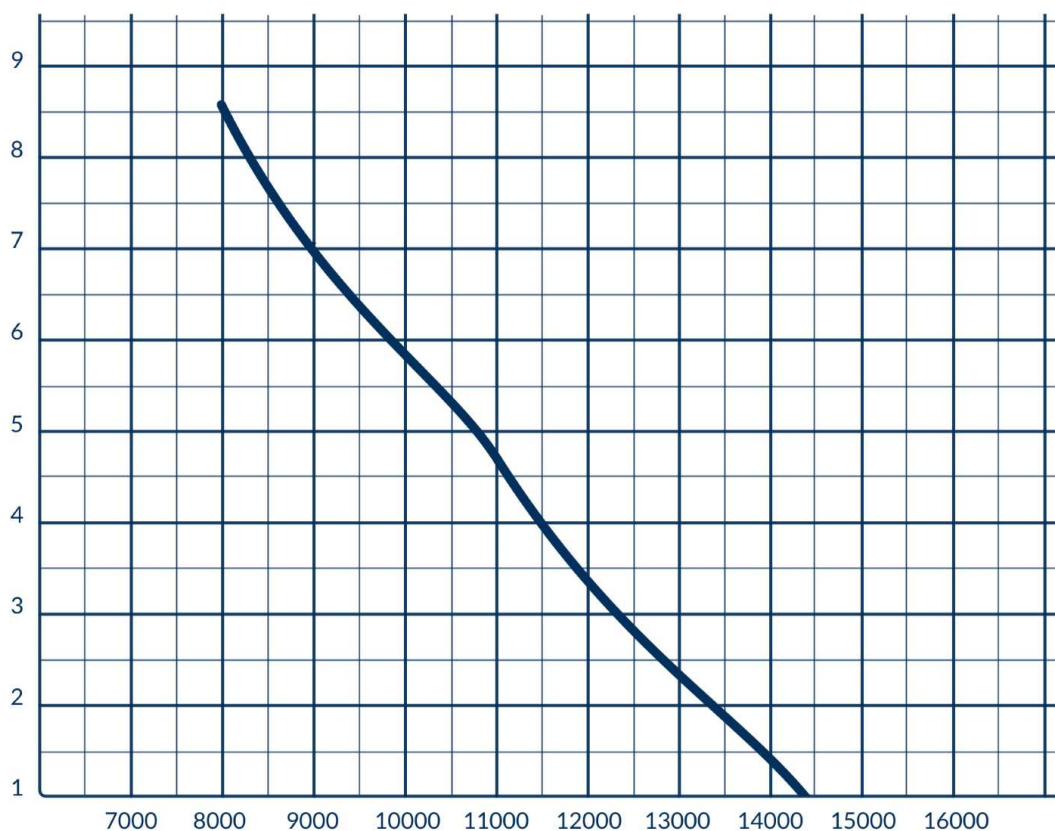

700  
rpm

0.75  
kW

## Ventilmotor s.r.l. a socio unico

**Uffici e Stabilimento:** Via Piaggio, 74 - 20037 - Paderno Dugnano (MI) **Sede Legale:** Via G. Pogliani, 34 - Paderno Dugnano (MI)

**Tel:** +39 02.9101051 / +39 02.99041382 **Fax:** +39 02.9103661 **Web:** info@ventilmotor.com - www.ventilmotor.com

Capitale Sociale € 10400.00 i.v. - REA 1519030 - N° Registro Imprese MI 53691 - Partita IVA 02632870966



Certificate n° 10-Q-10177-TIC



# [ ETE 910 ]

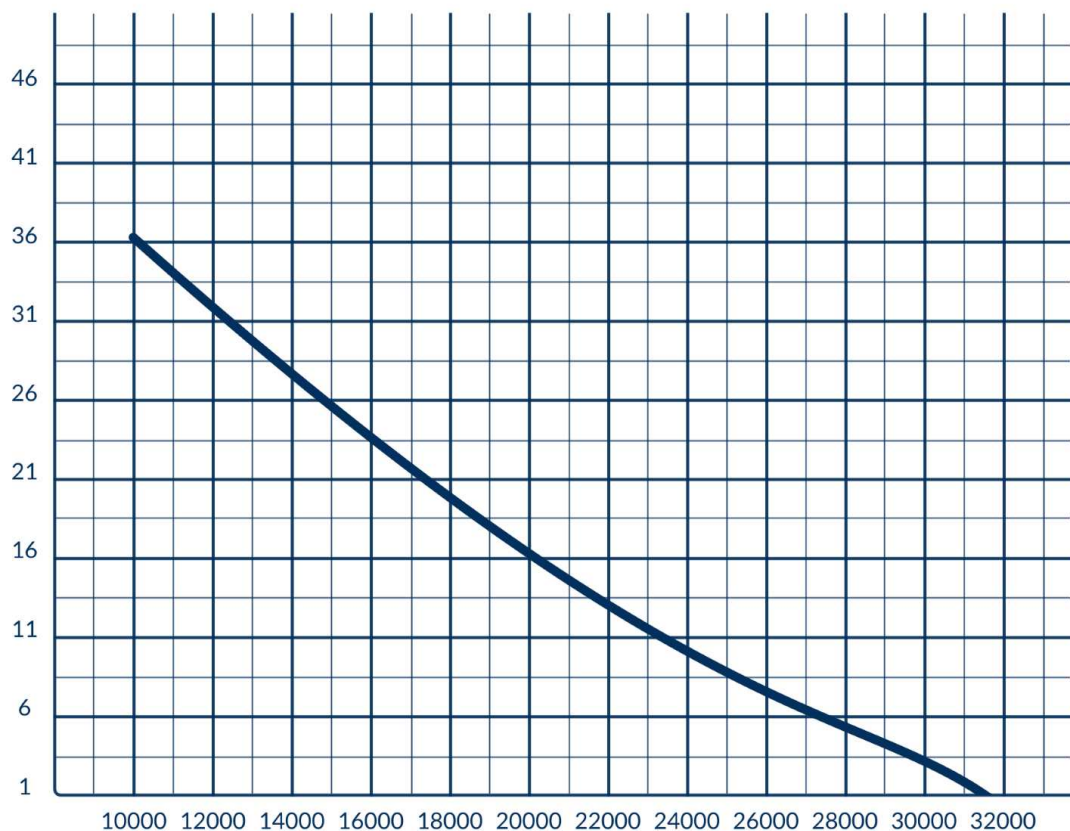

900  
rpm

3  
kW

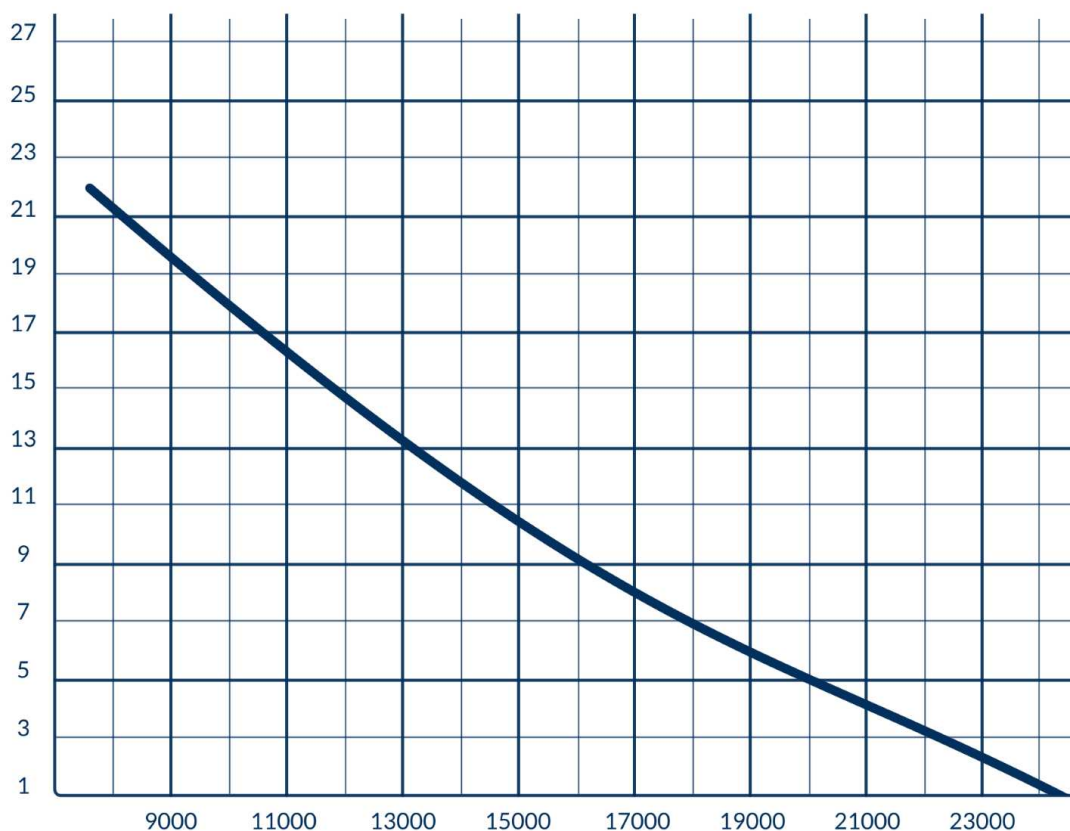

700  
rpm

1.5  
kW

## Ventilmotor s.r.l. a socio unico

**Uffici e Stabilimento:** Via Piaggio, 74 - 20037 - Paderno Dugnano (MI) **Sede Legale:** Via G. Pogliani, 34 - Paderno Dugnano (MI)

**Tel:** +39 02.9101051 / +39 02.99041382 **Fax:** +39 02.9103661 **Web:** info@ventilmotor.com - www.ventilmotor.com

Capitale Sociale € 10400.00 i.v. - REA 1519030 - N° Registro Imprese MI 53691 - Partita IVA 02632870966



Certificate n° 10-Q-10177-TIC