



Gli elettroventilatori  
 a torrino SERIE ET sono  
 particolarmente adatti per  
 l'aspirazione di aria o di fumi con  
 temperatura ambiente di 70°C.  
 Base di appoggio in acciaio.  
 Cupola in vetroresina.

Questi estrattori, la cui serie è costituita da 9  
 grandezze, sono adatti ad estrarre aria viziata  
 da edifici civili, industriali ed in particolare  
 servizi igienici, cucine, ecc ...

Ogni apparecchio è costituito da:  
 - Base-montanti-piastra portamotore e rete  
 protezione in acciaio zincato o verniciato  
 - Cappello di protezione in vetroresina  
 - Girante centrifuga a pale rovesciate in  
 lamiera di acciaio

## **Ventilmotor s.r.l. a socio unico**

**Uffici e Stabilimento:** Via Piaggio, 74 - 20037 - Paderno Dugnano (MI) **Sede Legale:** Via G. Pogliani, 34 - Paderno Dugnano (MI)

**Tel:** +39 02.9101051 / +39 02.99041382 **Fax:** +39 02.9103661 **Web:** info@ventilmotor.com - www.ventilmotor.com

Capitale Sociale € 10400.00 i.v. - REA 1519030 - N° Registro Imprese MI 53691 - Partita IVA 02632870966



Dimensioni  
e ingombri

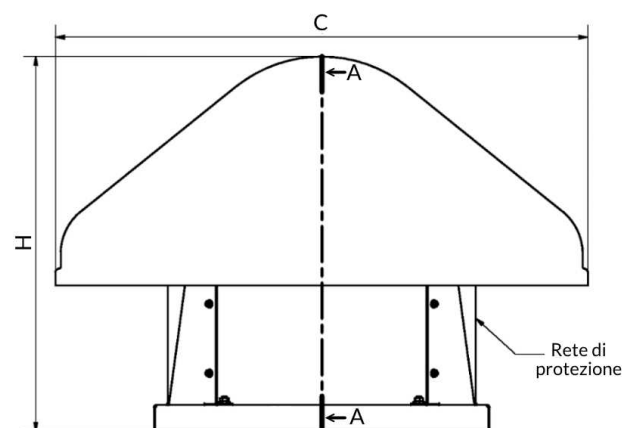
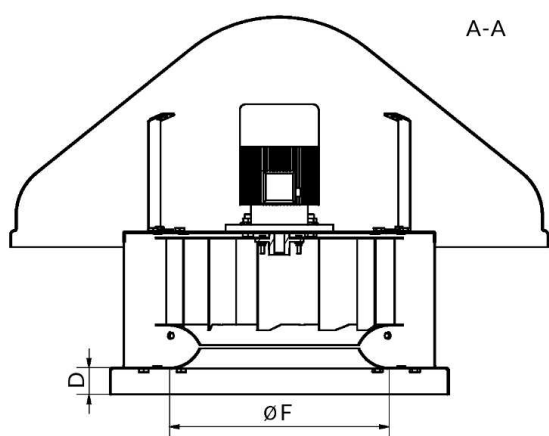
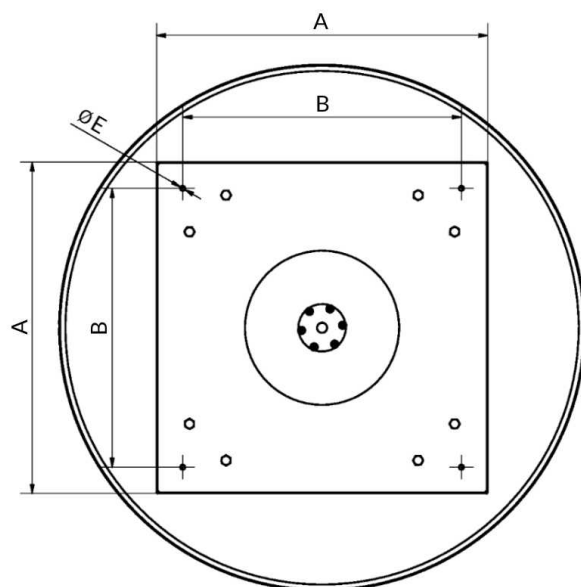

Modello	A	B	C	D	E	F	H
<b>ET21</b>	350	300	390	35	8	240	275
<b>ET24</b>	350	300	600	35	8	240	275
<b>ET27</b>	400	340	600	50	9	265	305
<b>ET32</b>	500	400	1000	50	9	315	355
<b>ET37</b>	560	460	1000	50	9	365	415
<b>ET42</b>	630	530	1000	50	9	420	468
<b>ET47</b>	710	610	1000	50	9	470	512
<b>ET52</b>	800	700	1600	50	9	520	565
<b>ET57</b>	900	800	1600	50	9	570	625
<b>ET62</b>	900	800	1600	50	9	620	675

**Ventilmotor s.r.l. a socio unico**

**Uffici e Stabilimento:** Via Piaggio, 74 - 20037 - Paderno Dugnano (MI) **Sede Legale:** Via G. Pogliani, 34 - Paderno Dugnano (MI)

**Tel:** +39 02.9101051 / +39 02.99041382 **Fax:** +39 02.9103661 **Web:** info@ventilmotor.com - www.ventilmotor.com

Capitale Sociale € 10400.00 i.v. - REA 1519030 - N° Registro Imprese MI 53691 - Partita IVA 02632870966



Certificate n° 10-Q-10177-TIC



# [ ET 21 ]

[ Il modello ET21 prevede la cupola in alluminio ]

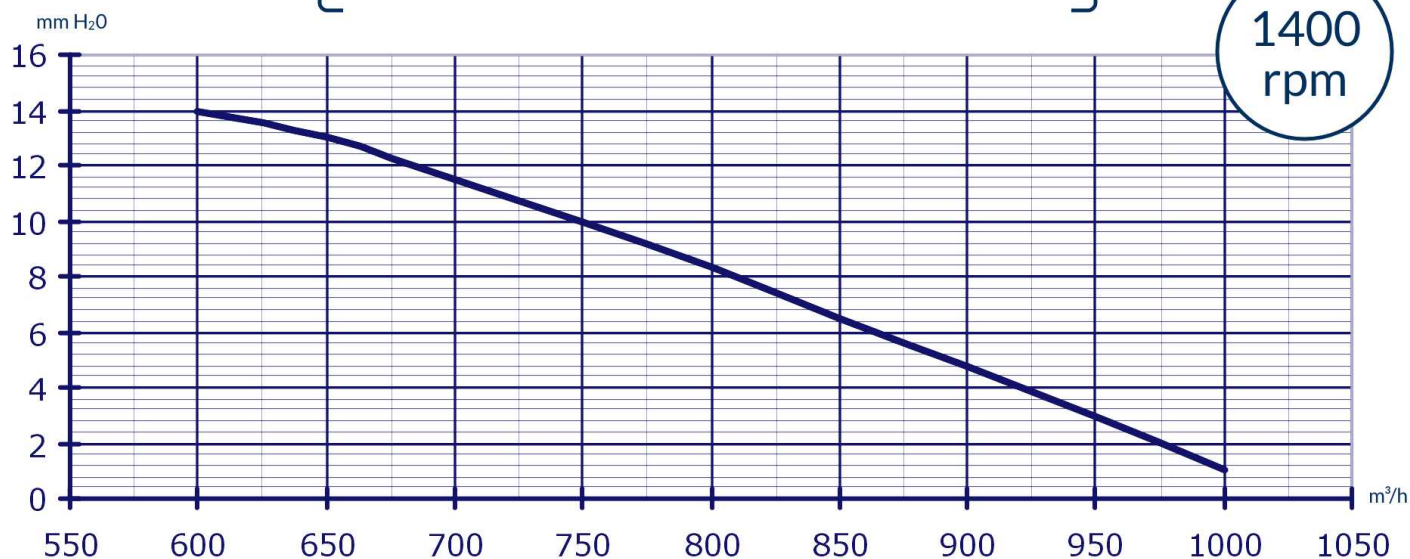

[ 0.12kW ]

[ 54dBA ]

[ 18Kg ]

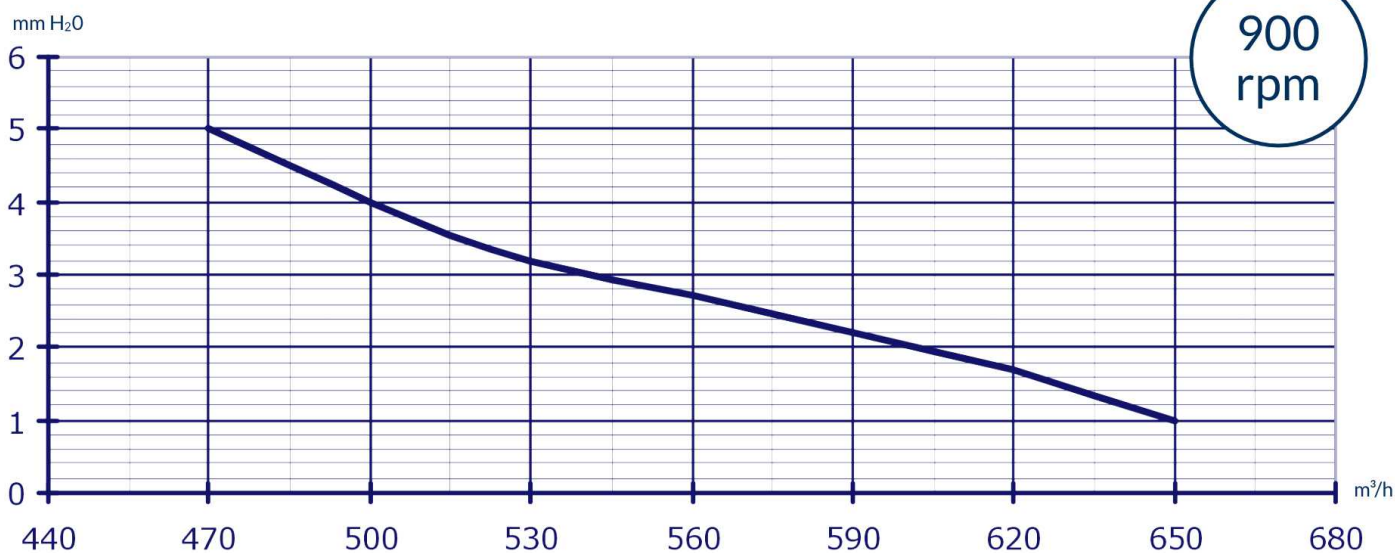

[ 0.09kW ]

[ 43dBA ]

[ 18Kg ]

## Ventilmotor s.r.l. a socio unico

Uffici e Stabilimento: Via Piaggio, 74 - 20037 - Paderno Dugnano (MI) Sede Legale: Via G. Pogliani, 34 - Paderno Dugnano (MI)

Tel: +39 02.9101051 / +39 02.99041382 Fax: +39 02.9103661 Web: info@ventilmotor.com - www.ventilmotor.com

Capitale Sociale € 10400.00 i.v. - REA 1519030 - N° Registro Imprese MI 53691 - Partita IVA 02632870966



Certificate n° 10-Q-10177-TIC



# [ ET 24 ]

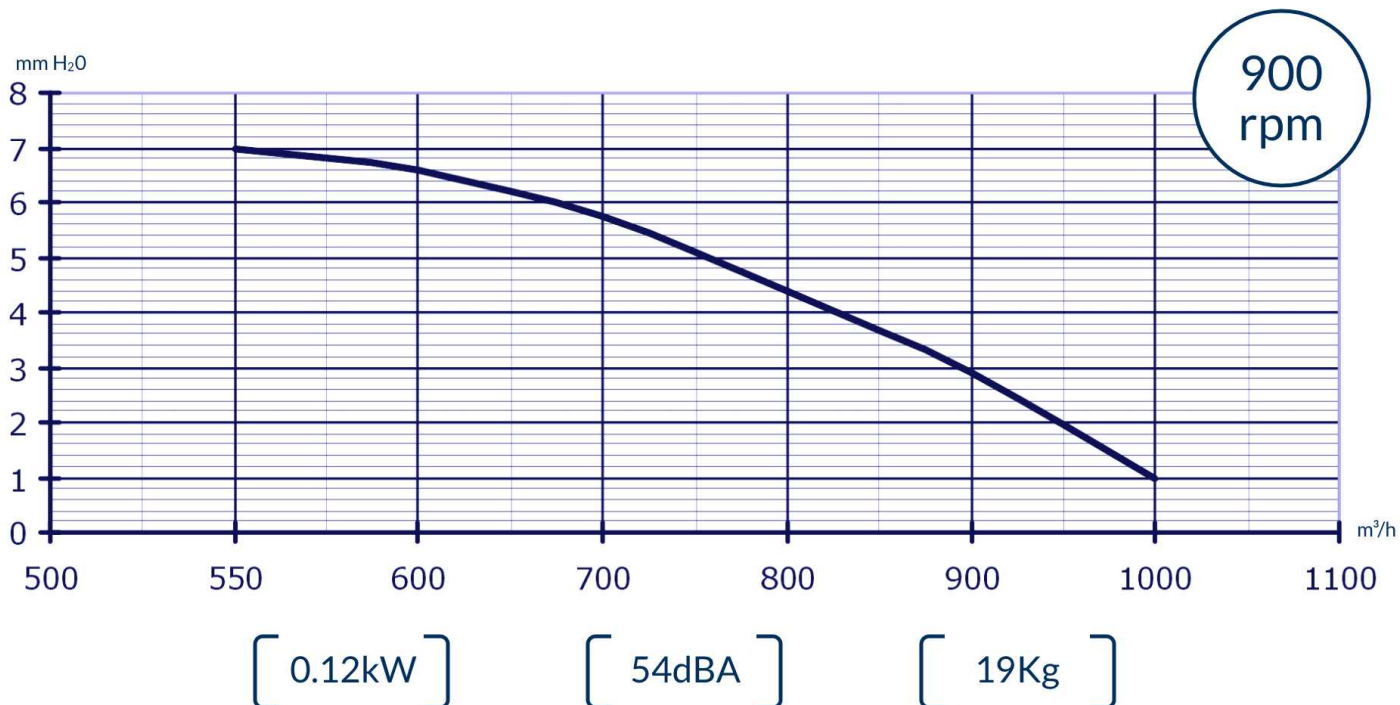
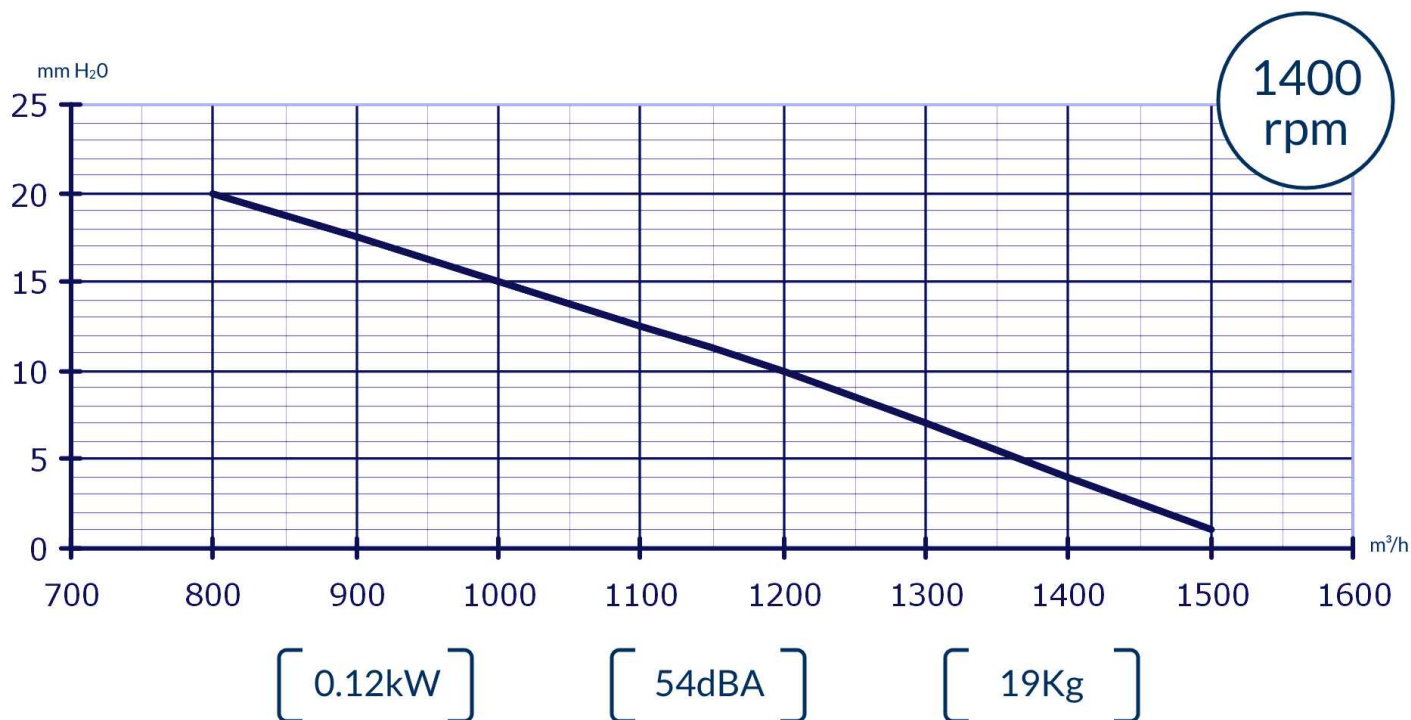

## Ventilmotor s.r.l. a socio unico

**Uffici e Stabilimento:** Via Piaggio, 74 - 20037 - Paderno Dugnano (MI) **Sede Legale:** Via G. Pogliani, 34 - Paderno Dugnano (MI)

**Tel:** +39 02.9101051 / +39 02.99041382 **Fax:** +39 02.9103661 **Web:** info@ventilmotor.com - www.ventilmotor.com

Capitale Sociale € 10400.00 i.v. - REA 1519030 - N° Registro Imprese MI 53691 - Partita IVA 02632870966



Certificate n° 10-Q-10177-TIC





# [ ET 27 ]

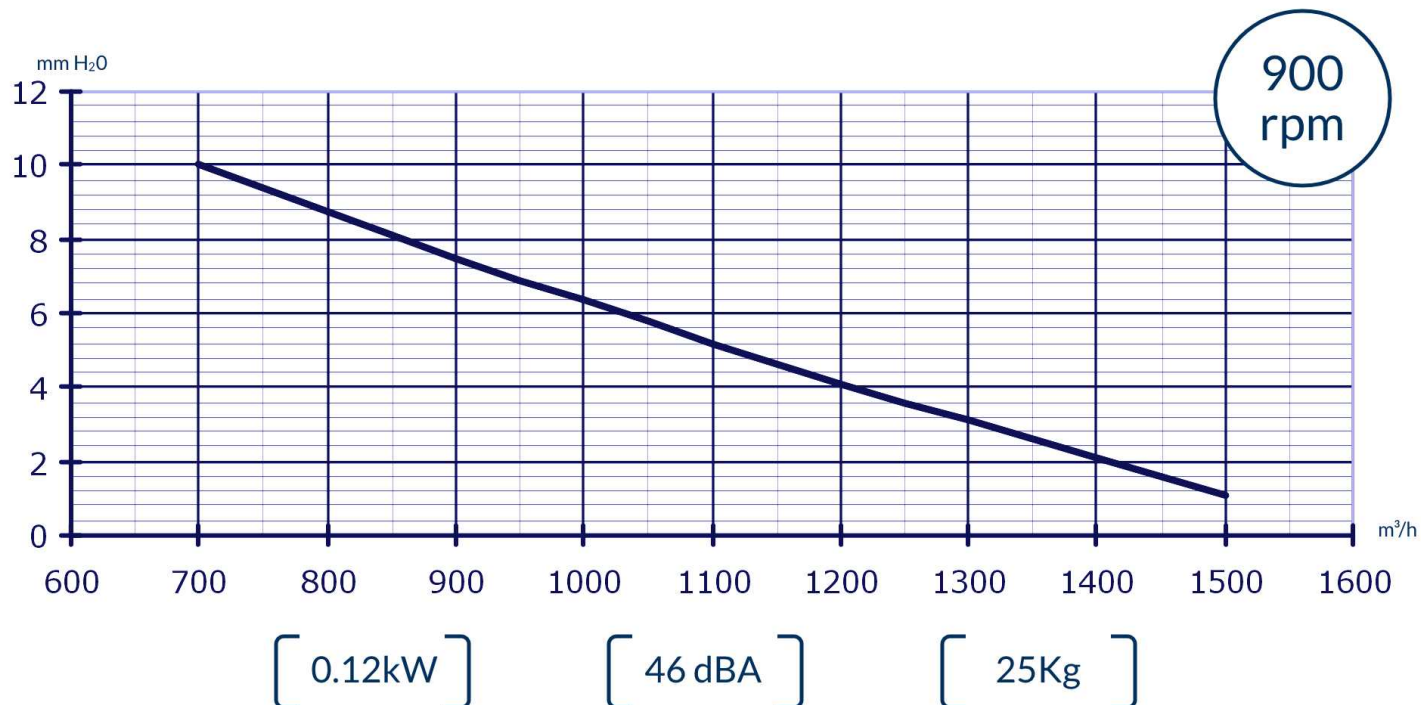
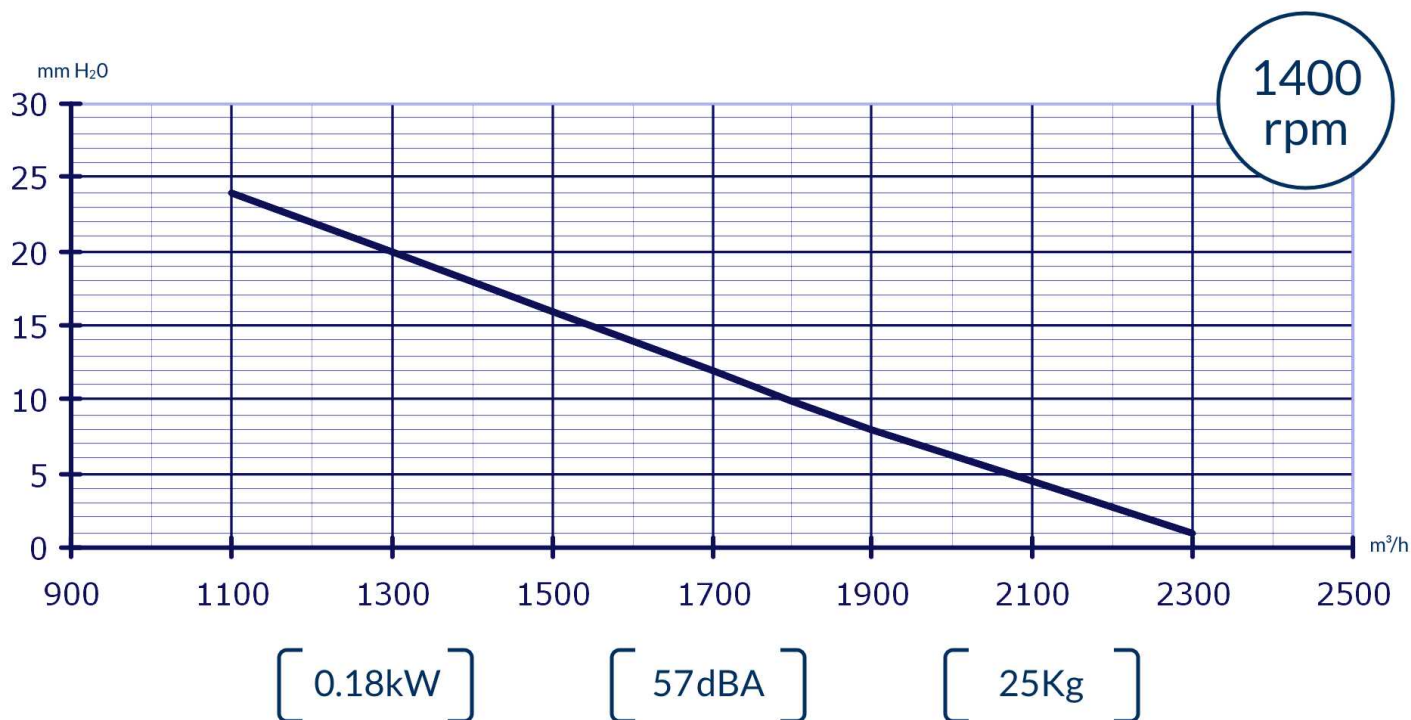

## Ventilmotor s.r.l. a socio unico

**Uffici e Stabilimento:** Via Piaggio, 74 - 20037 - Paderno Dugnano (MI) **Sede Legale:** Via G. Pogliani, 34 - Paderno Dugnano (MI)

**Tel:** +39 02.9101051 / +39 02.99041382 **Fax:** +39 02.9103661 **Web:** info@ventilmotor.com - www.ventilmotor.com

Capitale Sociale € 10400.00 i.v. - REA 1519030 - N° Registro Imprese MI 53691 - Partita IVA 02632870966



Certificate n° 10-Q-10177-TIC



# [ ET 32 ]

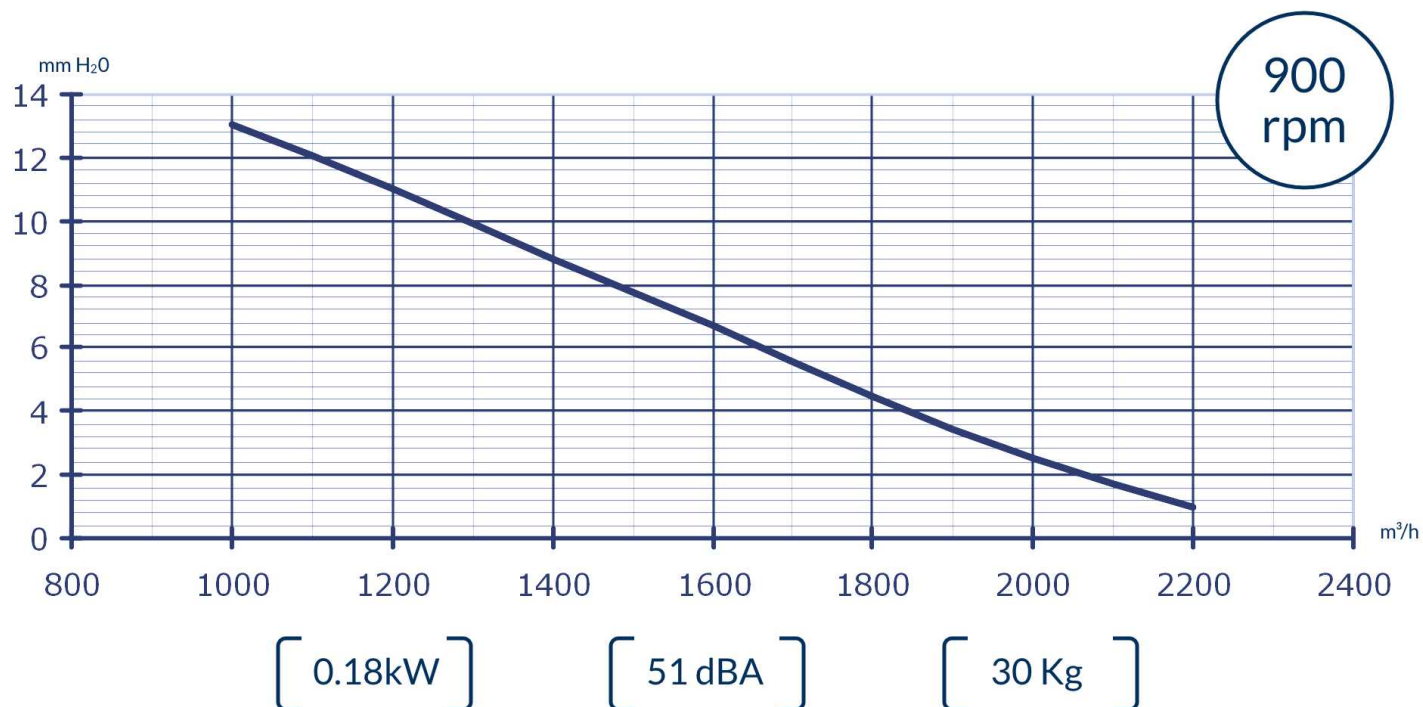
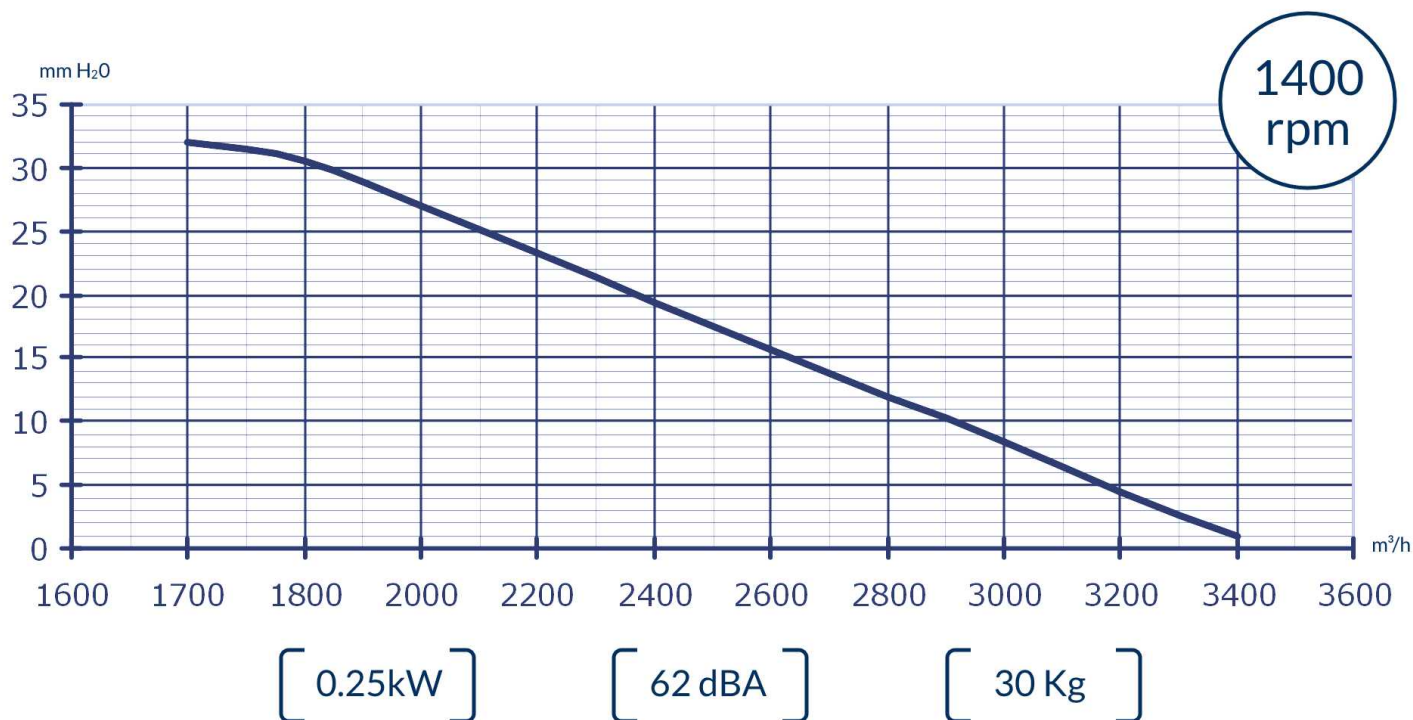

## Ventilmotor s.r.l. a socio unico

**Uffici e Stabilimento:** Via Piaggio, 74 - 20037 - Paderno Dugnano (MI) **Sede Legale:** Via G. Pogliani, 34 - Paderno Dugnano (MI)

**Tel:** +39 02.9101051 / +39 02.99041382 **Fax:** +39 02.9103661 **Web:** info@ventilmotor.com - www.ventilmotor.com

Capitale Sociale € 10400.00 i.v. - REA 1519030 - N° Registro Imprese MI 53691 - Partita IVA 02632870966



Certificate n° 10-Q-10177-TIC



# [ ET 37 ]

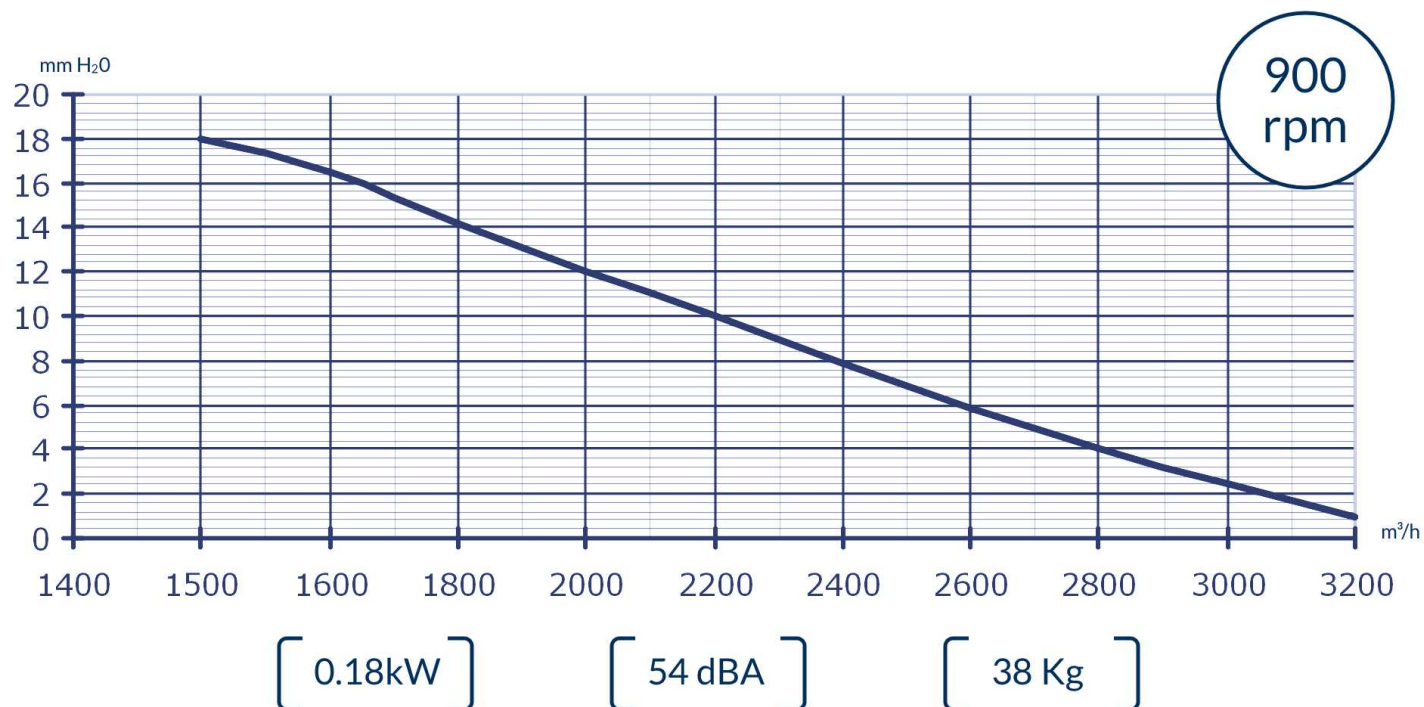
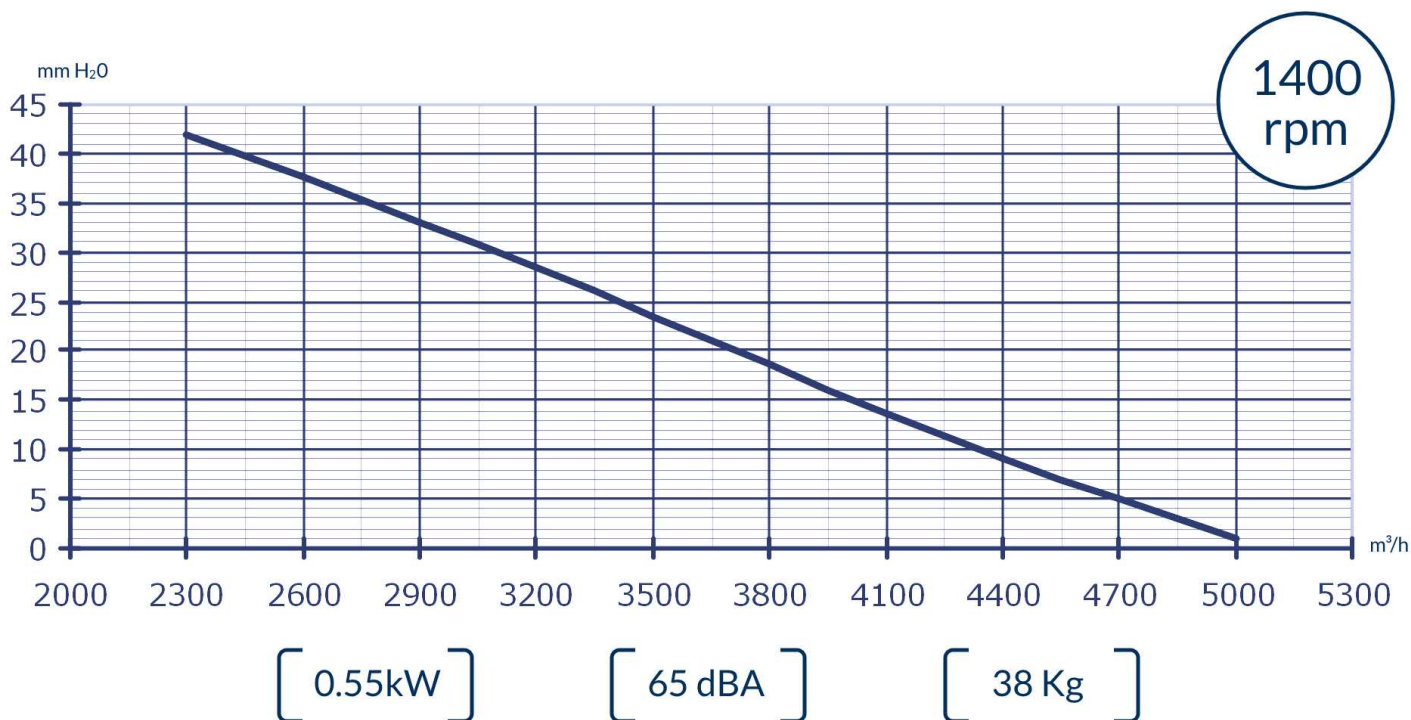

## Ventilmotor s.r.l. a socio unico

Uffici e Stabilimento: Via Piaggio, 74 - 20037 - Paderno Dugnano (MI) Sede Legale: Via G. Pogliani, 34 - Paderno Dugnano (MI)

Tel: +39 02.9101051 / +39 02.99041382 Fax: +39 02.9103661 Web: info@ventilmotor.com - www.ventilmotor.com

Capitale Sociale € 10400.00 i.v. - REA 1519030 - N° Registro Imprese MI 53691 - Partita IVA 02632870966



Certificate n° 10-Q-10177-TIC





# [ ET 42 ]

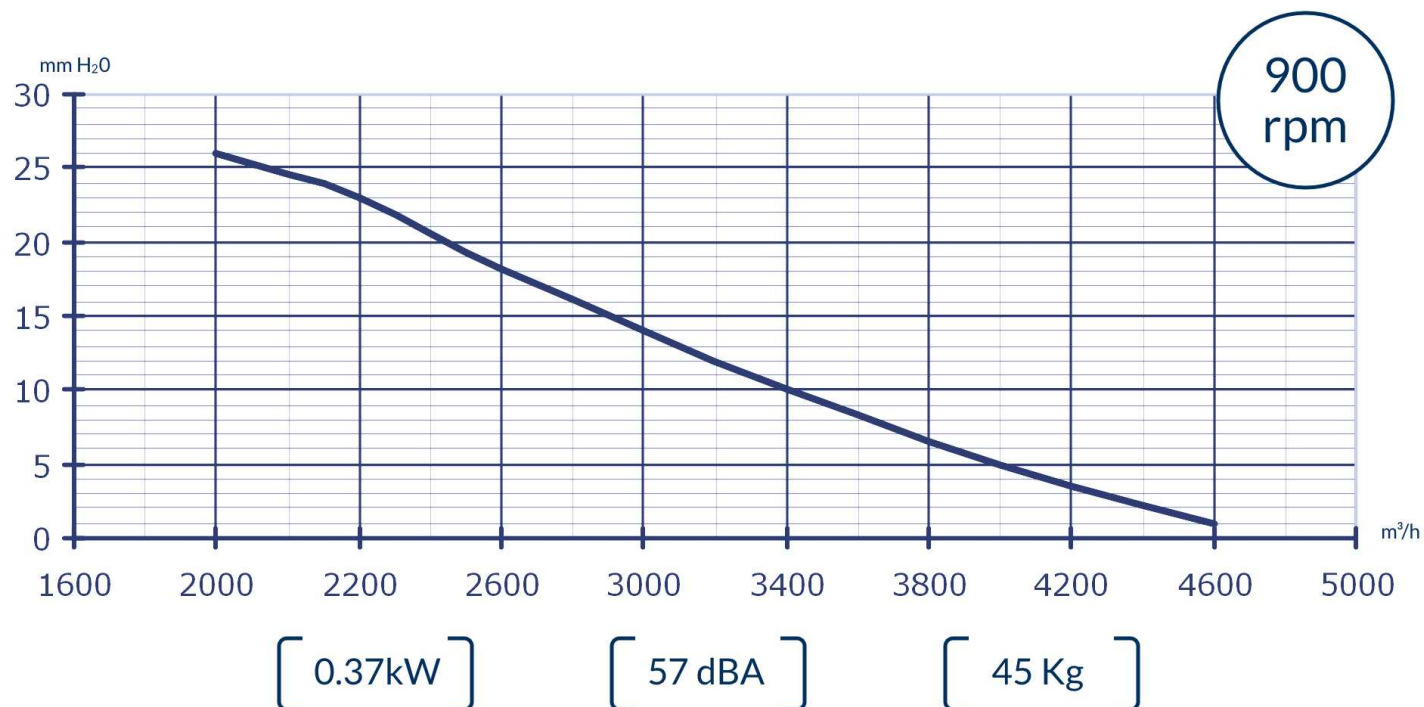
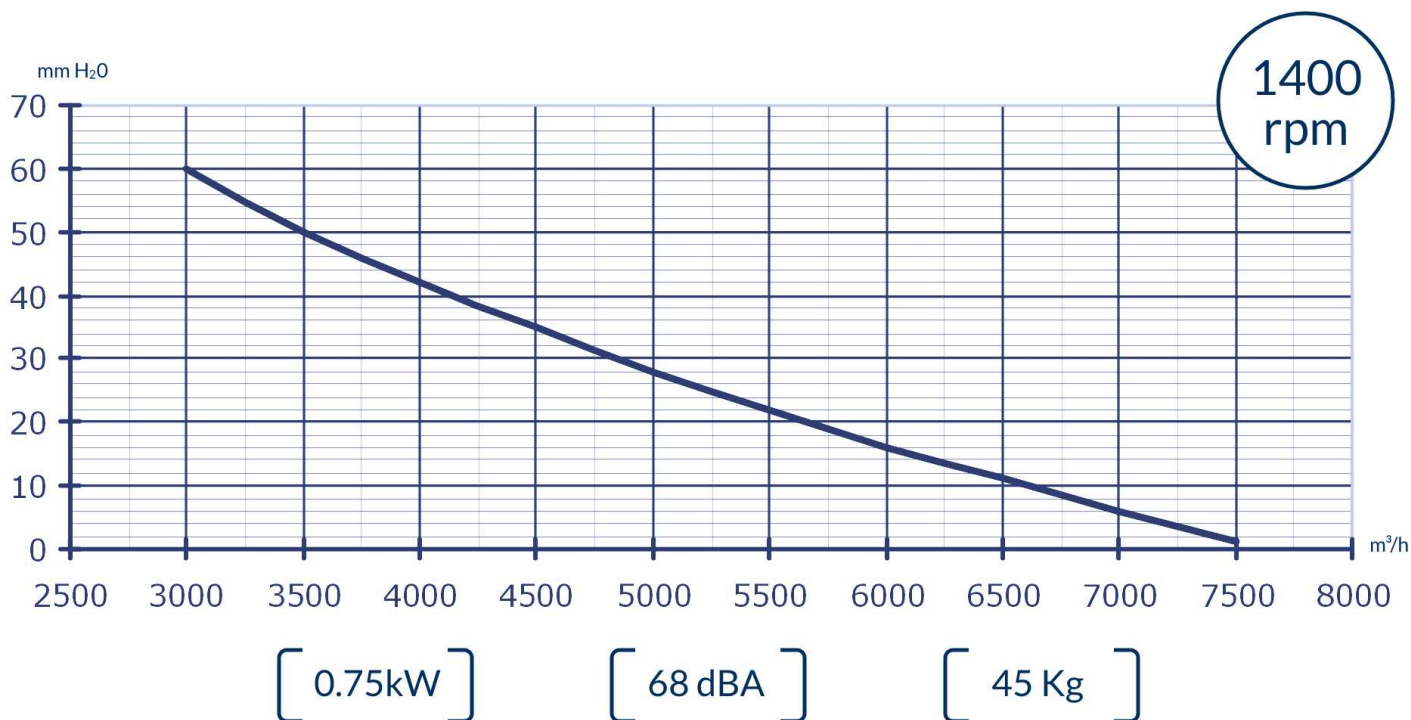

## Ventilmotor s.r.l. a socio unico

Uffici e Stabilimento: Via Piaggio, 74 - 20037 - Paderno Dugnano (MI) Sede Legale: Via G. Pogliani, 34 - Paderno Dugnano (MI)

Tel: +39 02.9101051 / +39 02.99041382 Fax: +39 02.9103661 Web: info@ventilmotor.com - www.ventilmotor.com

Capitale Sociale € 10400.00 i.v. - REA 1519030 - N° Registro Imprese MI 53691 - Partita IVA 02632870966



Certificate n° 10-Q-10177-TIC





# [ ET 47 ]

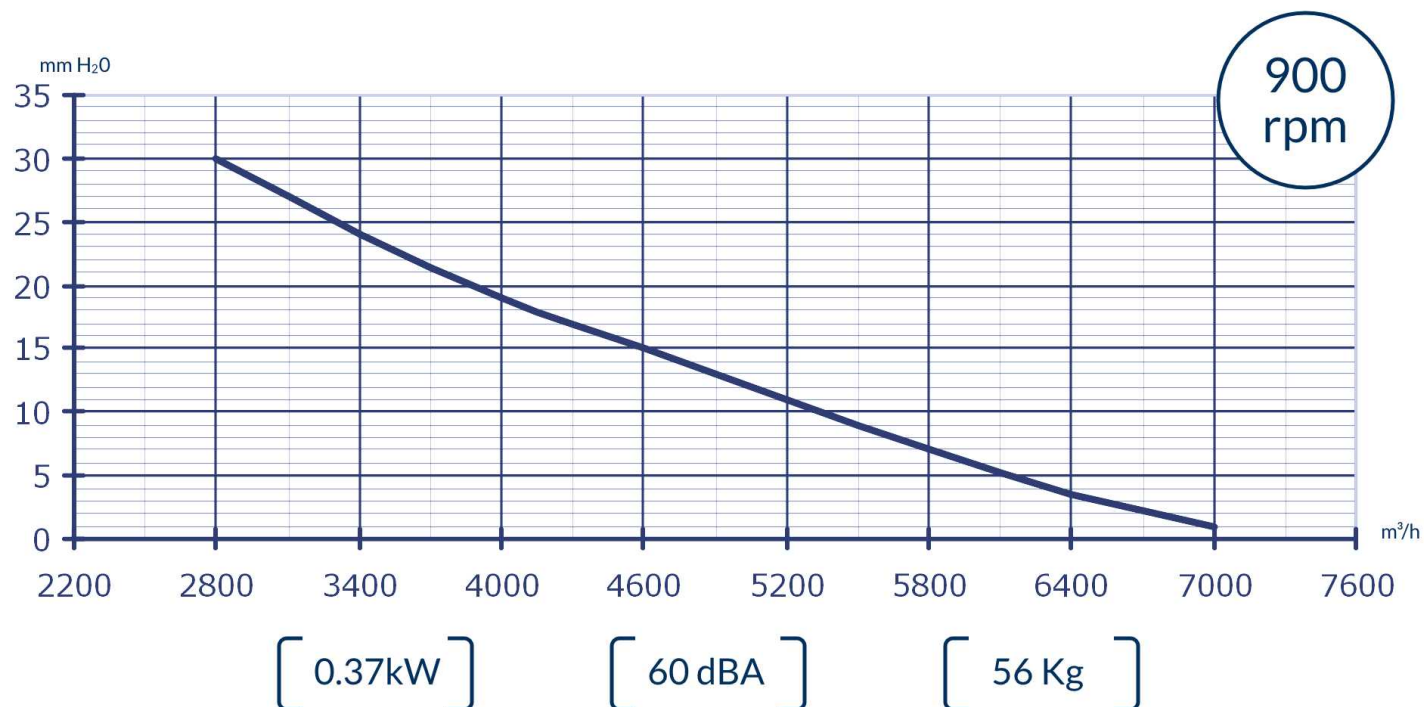
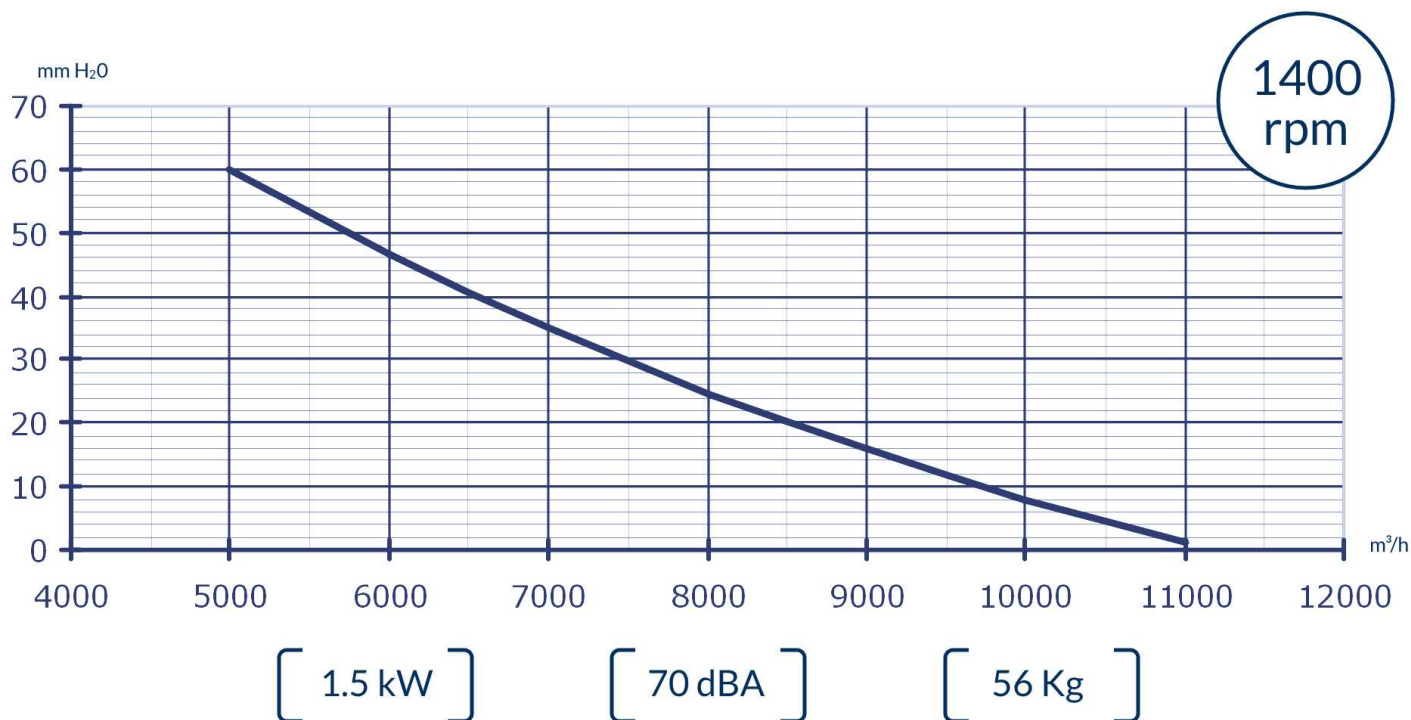

## Ventilmotor s.r.l. a socio unico

**Uffici e Stabilimento:** Via Piaggio, 74 - 20037 - Paderno Dugnano (MI) **Sede Legale:** Via G. Pogliani, 34 - Paderno Dugnano (MI)

**Tel:** +39 02.9101051 / +39 02.99041382 **Fax:** +39 02.9103661 **Web:** info@ventilmotor.com - www.ventilmotor.com

Capitale Sociale € 10400.00 i.v. - REA 1519030 - N° Registro Imprese MI 53691 - Partita IVA 02632870966



Certificate n° 10-Q-10177-TIC



# [ ET 52 ]

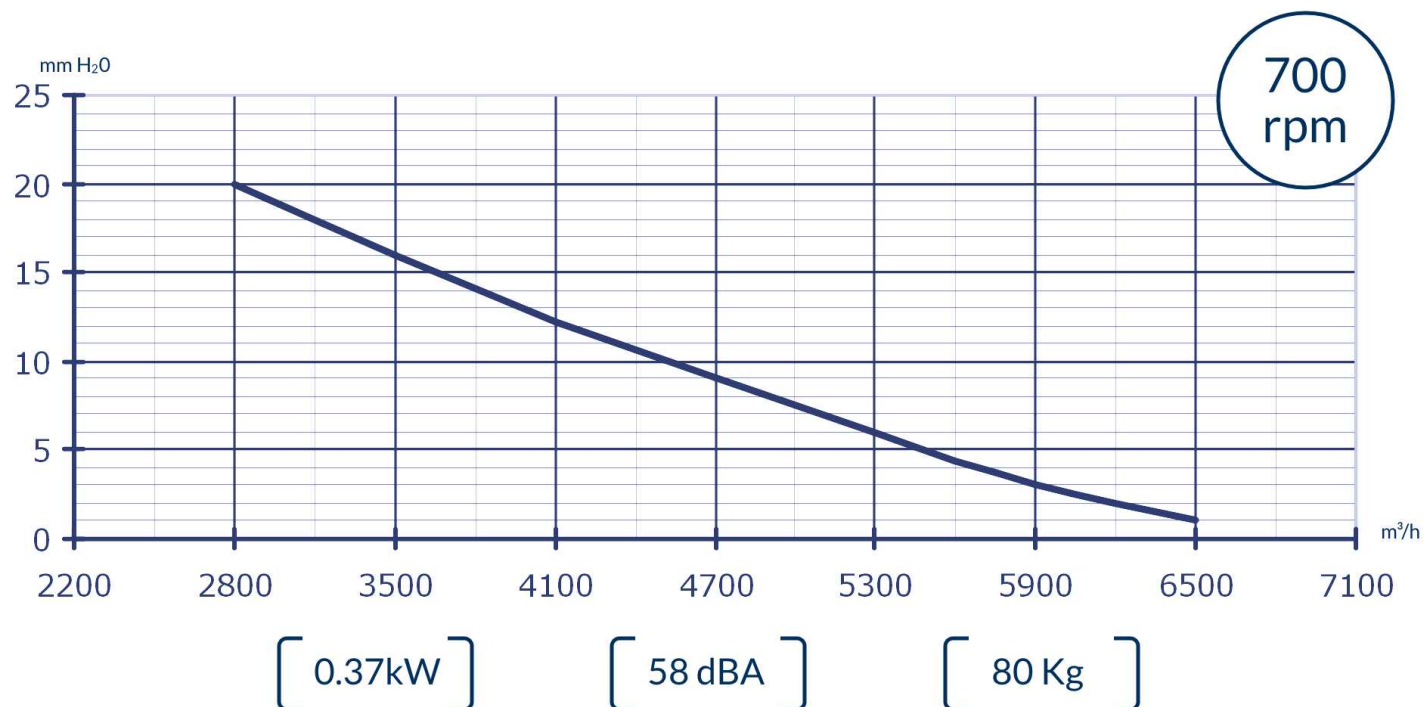
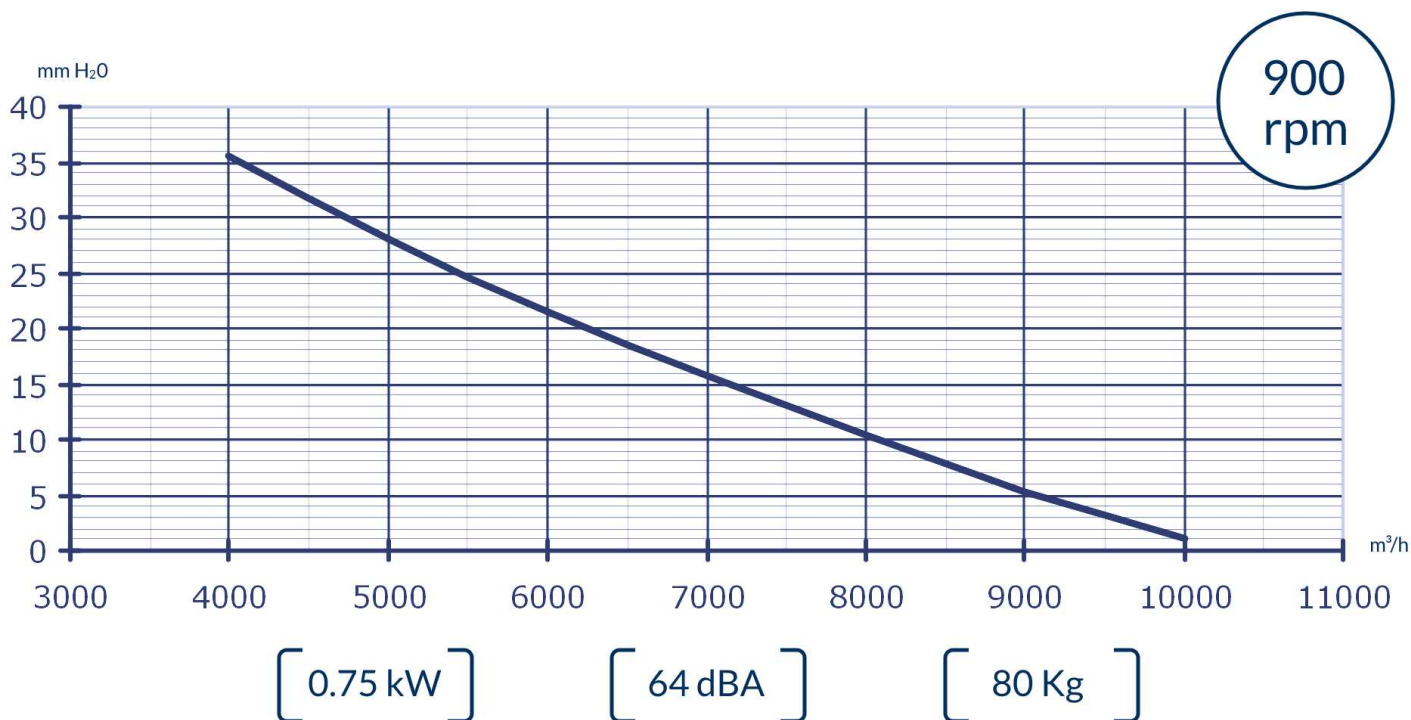

## Ventilmotor s.r.l. a socio unico

**Uffici e Stabilimento:** Via Piaggio, 74 - 20037 - Paderno Dugnano (MI) **Sede Legale:** Via G. Pogliani, 34 - Paderno Dugnano (MI)

**Tel:** +39 02.9101051 / +39 02.99041382 **Fax:** +39 02.9103661 **Web:** info@ventilmotor.com - www.ventilmotor.com

Capitale Sociale € 10400.00 i.v. - REA 1519030 - N° Registro Imprese MI 53691 - Partita IVA 02632870966



Certificate n° 10-Q-10177-TIC



# [ ET 57 ]

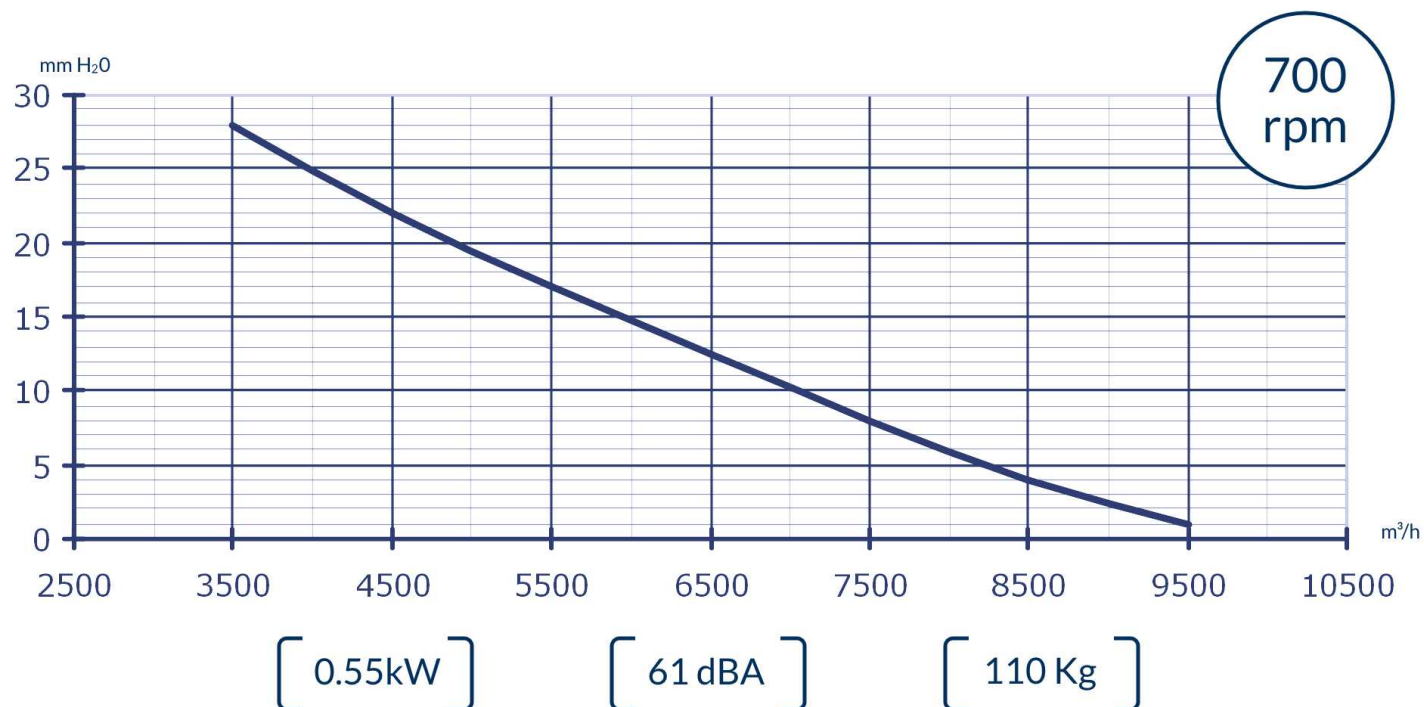
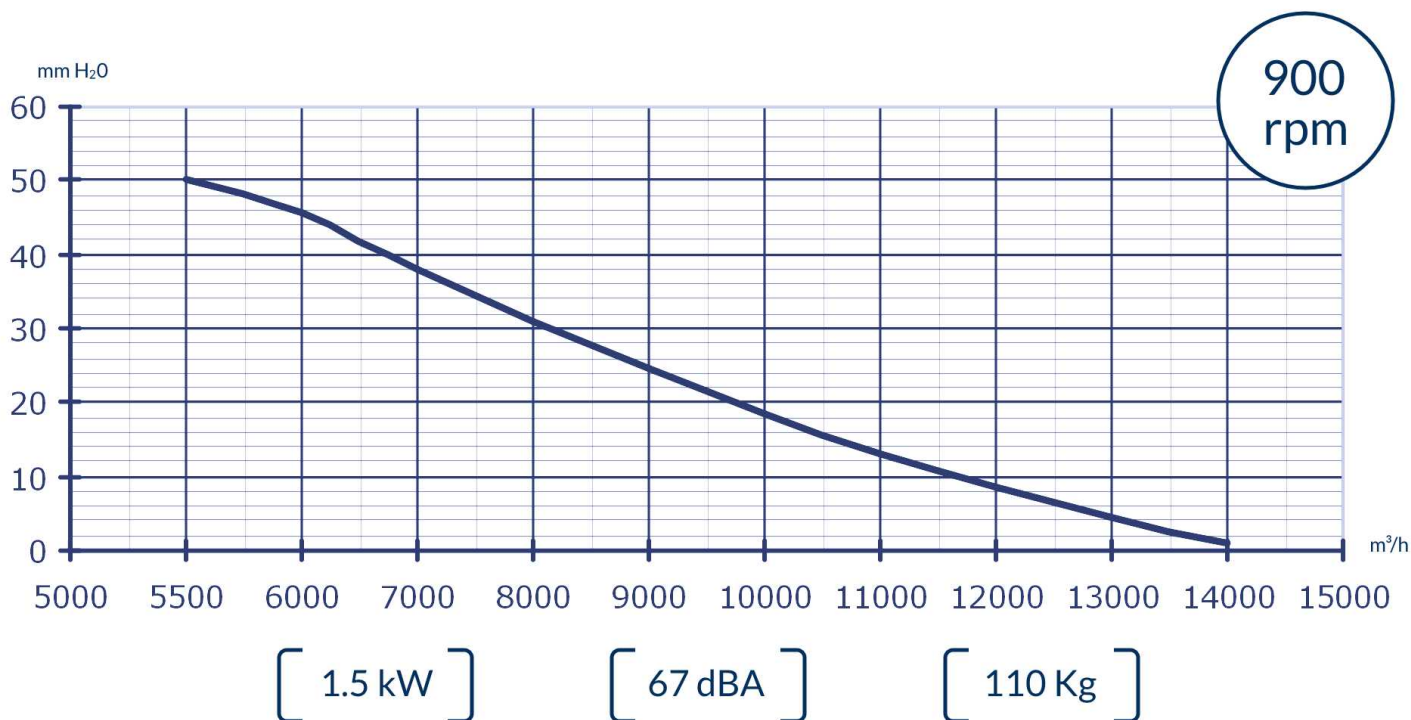

## Ventilmotor s.r.l. a socio unico

**Uffici e Stabilimento:** Via Piaggio, 74 - 20037 - Paderno Dugnano (MI) **Sede Legale:** Via G. Pogliani, 34 - Paderno Dugnano (MI)

**Tel:** +39 02.9101051 / +39 02.99041382 **Fax:** +39 02.9103661 **Web:** info@ventilmotor.com - www.ventilmotor.com

Capitale Sociale € 10400.00 i.v. - REA 1519030 - N° Registro Imprese MI 53691 - Partita IVA 02632870966



Certificate n° 10-Q-10177-TIC





# [ ET 62 ]

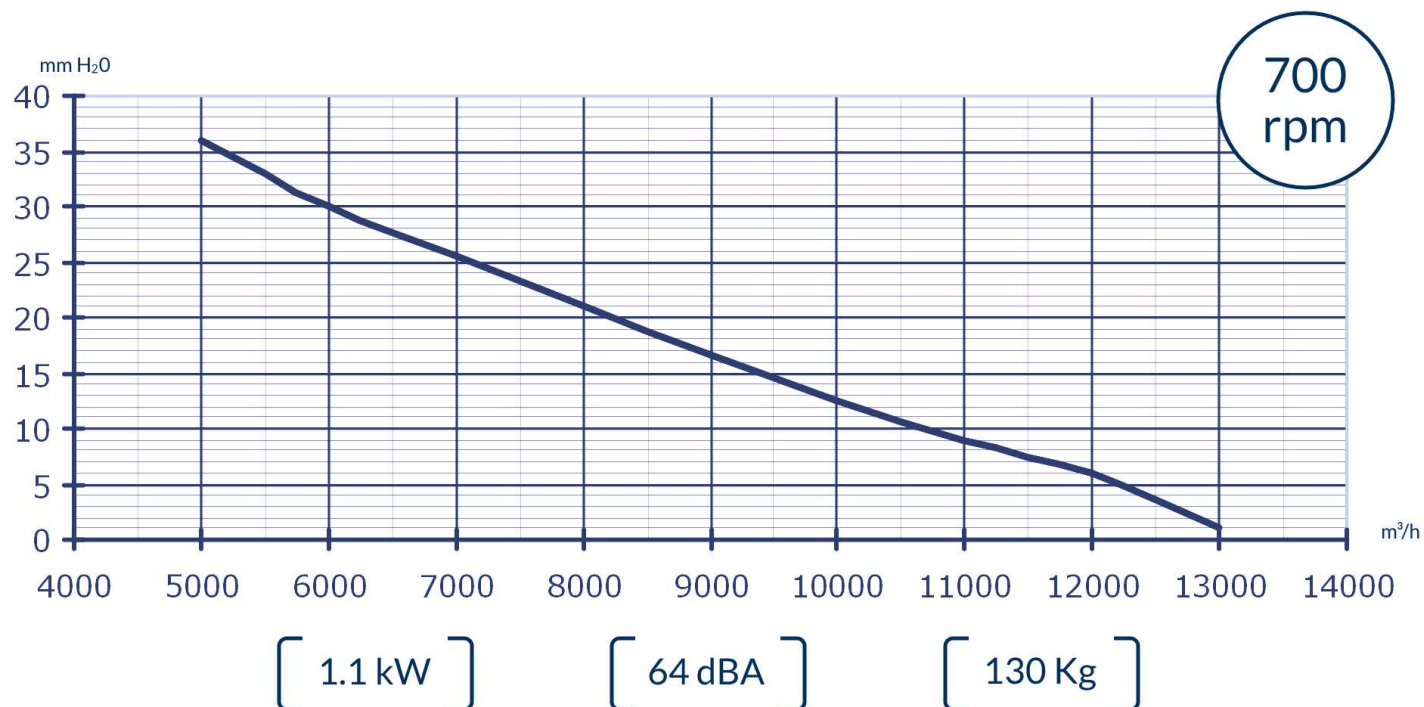
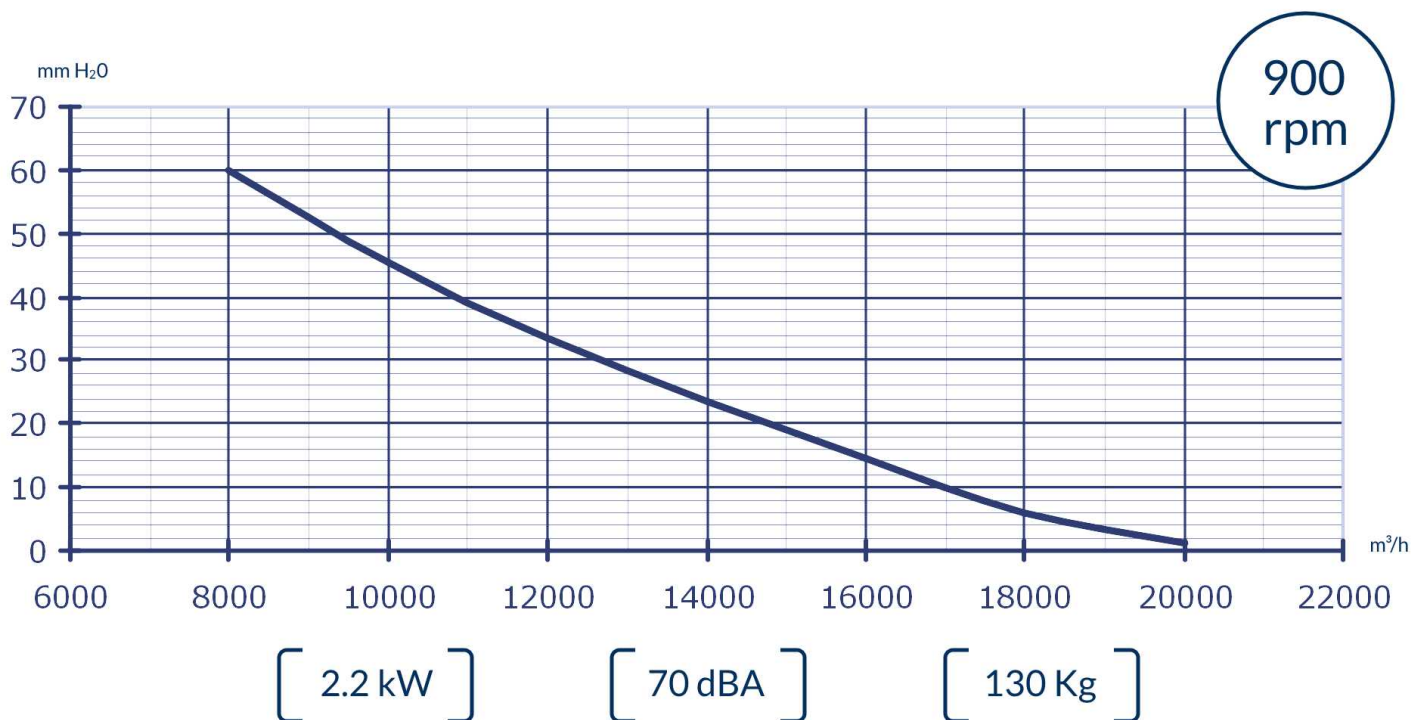

## Ventilmotor s.r.l. a socio unico

Uffici e Stabilimento: Via Piaggio, 74 - 20037 - Paderno Dugnano (MI) Sede Legale: Via G. Pogliani, 34 - Paderno Dugnano (MI)

Tel: +39 02.9101051 / +39 02.99041382 Fax: +39 02.9103661 Web: info@ventilmotor.com - www.ventilmotor.com

Capitale Sociale € 10400.00 i.v. - REA 1519030 - N° Registro Imprese MI 53691 - Partita IVA 02632870966



Certificate n° 10-Q-10177-TIC