

Ventole Elicoidali H-HF-HN

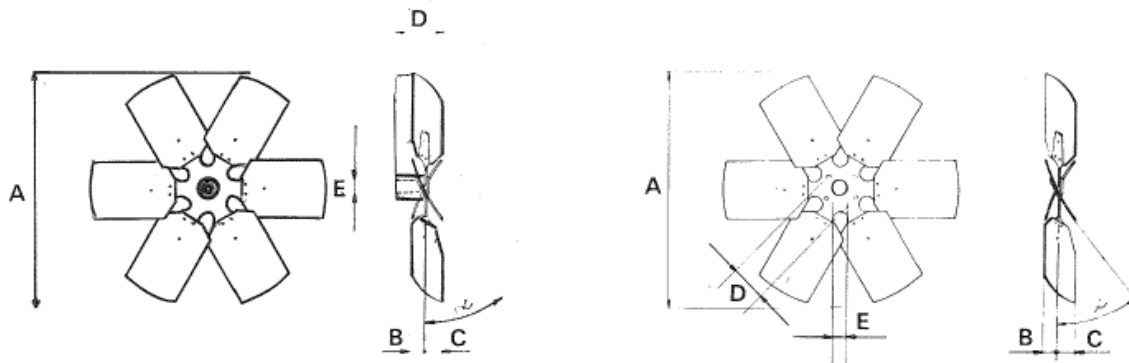

H	kg	A	α°	B	C
250	0.45	250	18	9	17
			23	13	20
			27	16	22
			36	22	27
300	0.48	300	18	9	17
			23	13	20
			27	16	22
			36	22	27
350	0.85	350	18	13	25
			23	19	29
			27	23	33
			36	32	40
400	1	400	18	13	25
			23	19	29
			27	22	34
			36	32	40
450	4.4	450	18	13	25
			23	19	29
			27	22	34
			36	32	40
500	2.1	500	18	16	30
			23	23	35
			27	25	40
			36	38	49
550	2.2	550	18	16	30
			23	23	35
			27	23	40
			36	38	49
600	2.8	600	18	20	36
			23	28	43
			27	34	48
			36	47	60
650	3	650	18	20	36
			23	28	43
			27	34	48
			36	47	60
700	3.2	700	18	20	36
			23	28	43
			27	34	48
			36	47	60
750	3.5	750	18	20	36
			23	28	43
			27	34	48
			36	47	60

HF	kg	A	α°	B	C
300	0.8	300	18	9	17
			23	13	20
			27	16	22
			36	22	27
350	1.4	350	18	13	25
			23	19	29
			27	23	33
			36	32	40
400	1.8	400	18	13	25
			23	19	29
			27	23	33
			36	32	40
450	2	450	18	13	25
			23	19	29
			27	23	33
			36	32	40

HN	D	E
250 ÷ 450	35	25
500 ÷ 750	70	20

N.B. - Mod. 250 ÷ 450 n. 4 fori \varnothing 7
 Mod. 500 ÷ 750 n. 4 fori \varnothing 9

Le quote D ed E dipendono dal tipo di mozzo montato (vedere prospetto mozzi).



ISO 9001
 Certificate N° 10-Q-10177-TIC

Ventilmotor S.r.l. a socio unico

Uffici e stabilimento: Via Piaggio, 74 - 20037 Paderno Dugnano (Mi) - **Sede Legale:** Via G. Pogliani, 34 - Paderno Dugnano (Mi)
 Tel. +39 02.9101051 / +39 02.99041382 - Fax: +39 02.9103661 - info@ventilmotor.com - www.ventilmotor.com

Cap. Sociale € 10400,00 i.v. - REA 1519030 - N. Registro Imprese MI 53691 - Partita IVA 02632870966

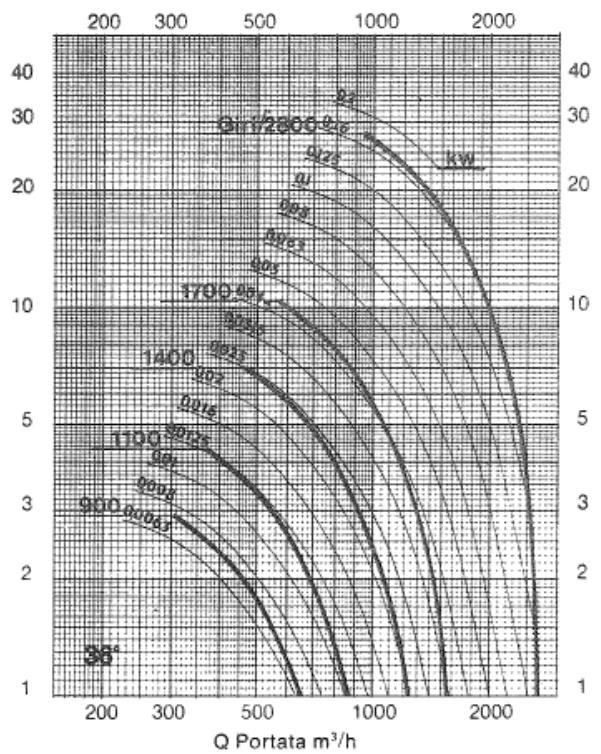
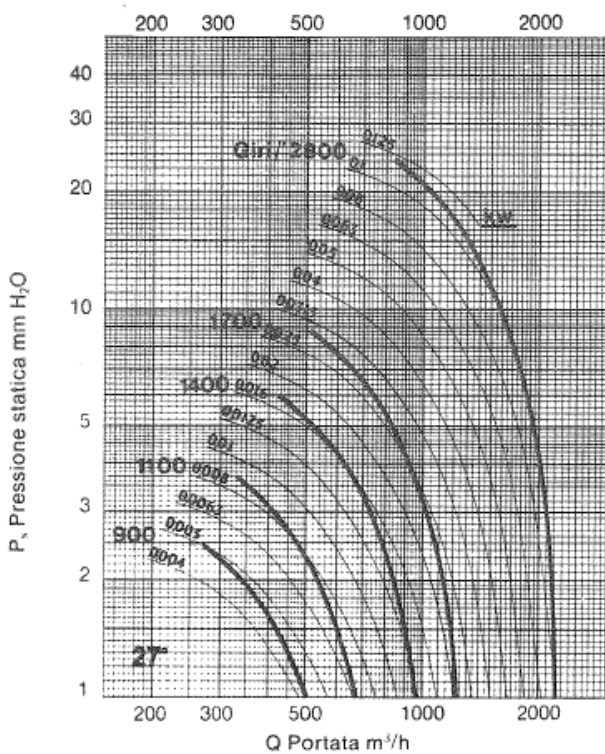
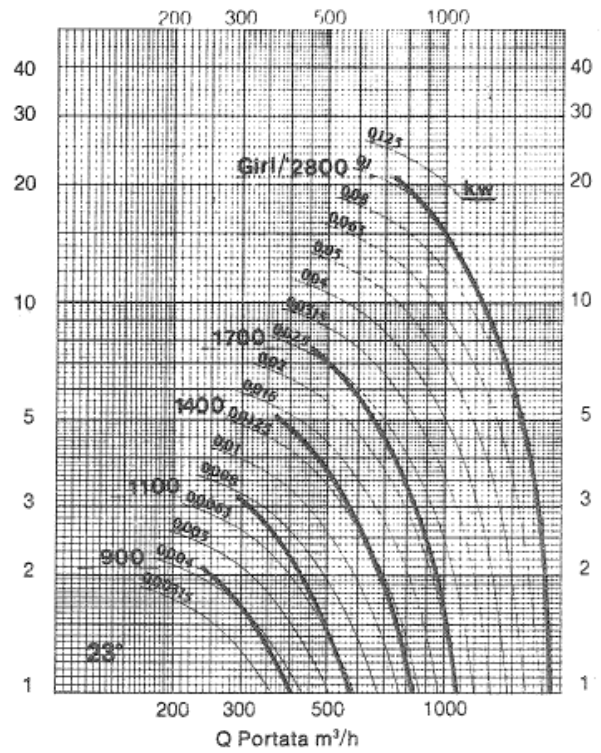
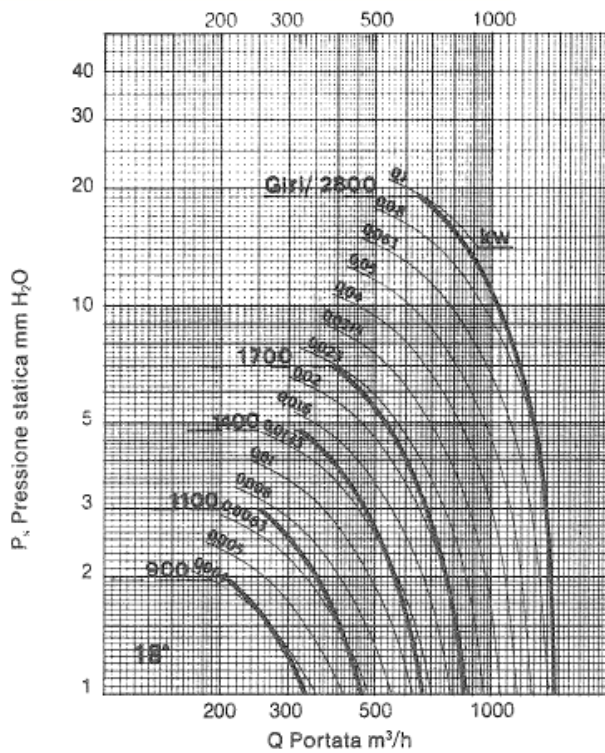

250



ISO 9001
Certificate N° 10-Q-10177-TIC

Ventilmotor S.r.l. a socio unico

Uffici e stabilimento: Via Piaggio, 74 - 20037 Paderno Dugnano (Mi) - **Sede Legale:** Via G. Pogliani, 34 - Paderno Dugnano (Mi)
Tel. +39 02.9101051 / +39 02.99041382 - Fax: +39 02.9103661 - info@ventilmotor.com - www.ventilmotor.com

Cap. Sociale € 10400,00 i.v. - REA 1519030 - N. Registro Imprese MI 53691 - Partita IVA 02632870966

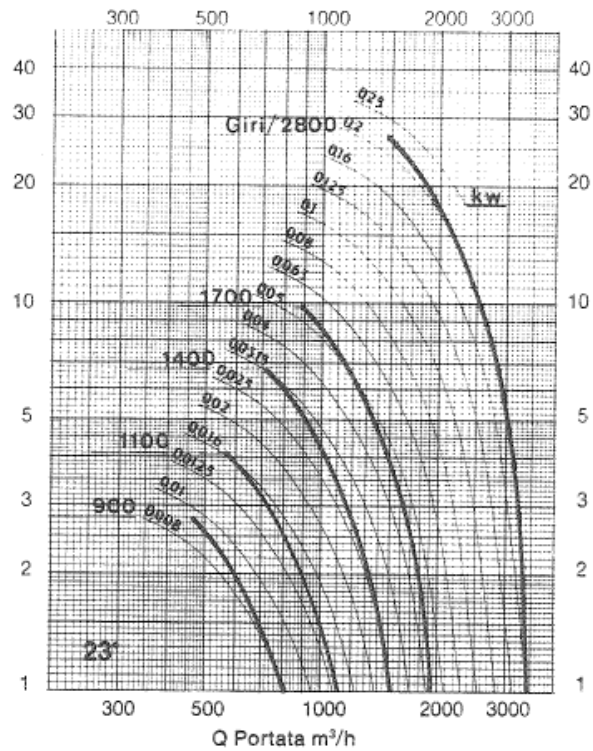
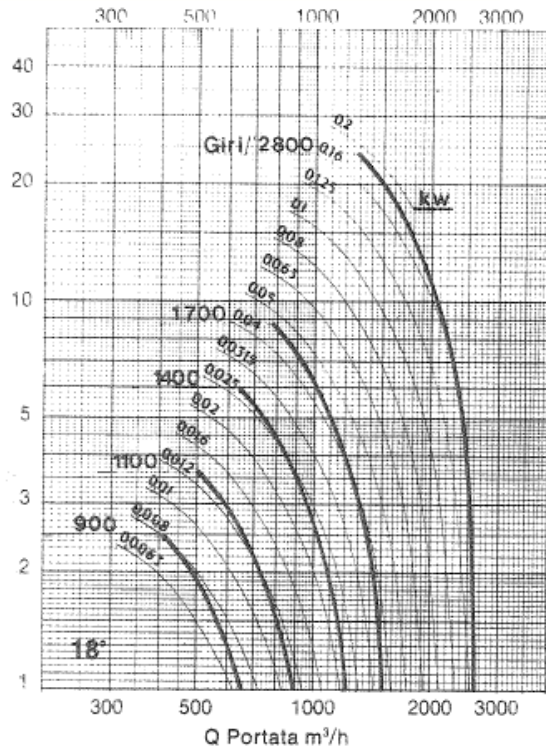

P_s Pressione statica mm H₂O

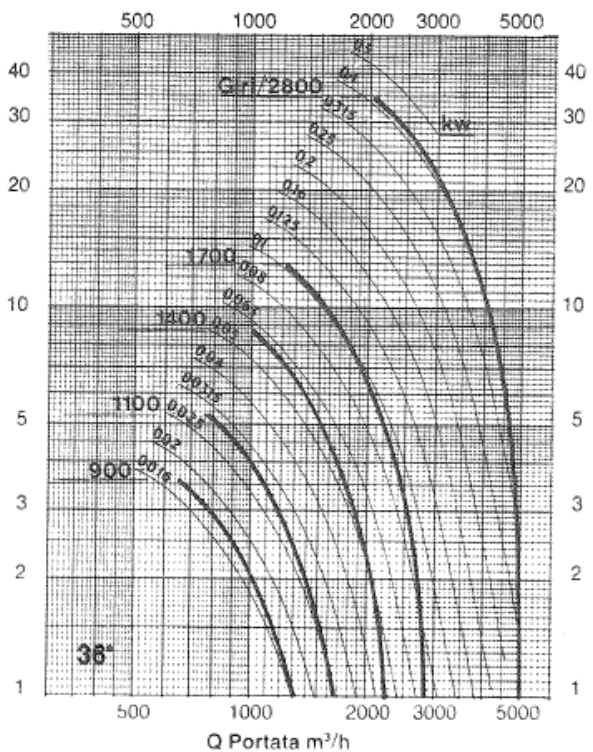
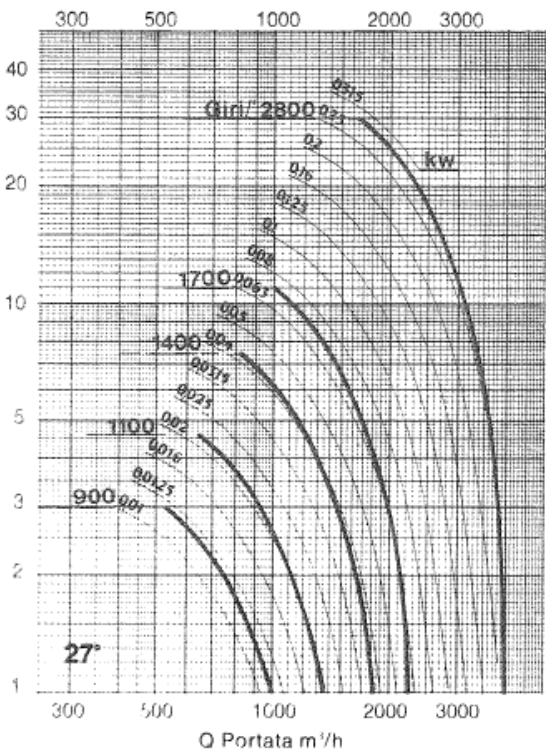

P_s Pressione statica mm H₂O

300



ISO 9001
Certificate N° 10-Q-10177-TIC

Ventilmotor S.r.l. a socio unico

Uffici e stabilimento: Via Piaggio, 74 - 20037 Paderno Dugnano (Mi) - **Sede Legale:** Via G. Pogliani, 34 - Paderno Dugnano (Mi)
Tel. +39 02.9101051 / +39 02.99041382 - Fax: +39 02.9103661 - info@ventilmotor.com - www.ventilmotor.com

Cap. Sociale € 10400,00 i.v. - REA 1519030 - N. Registro Imprese MI 53691 - Partita IVA 02632870966

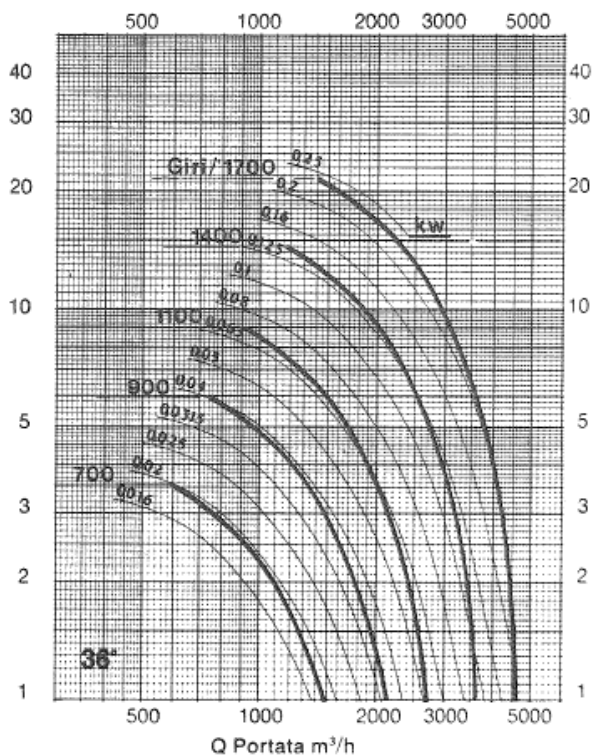
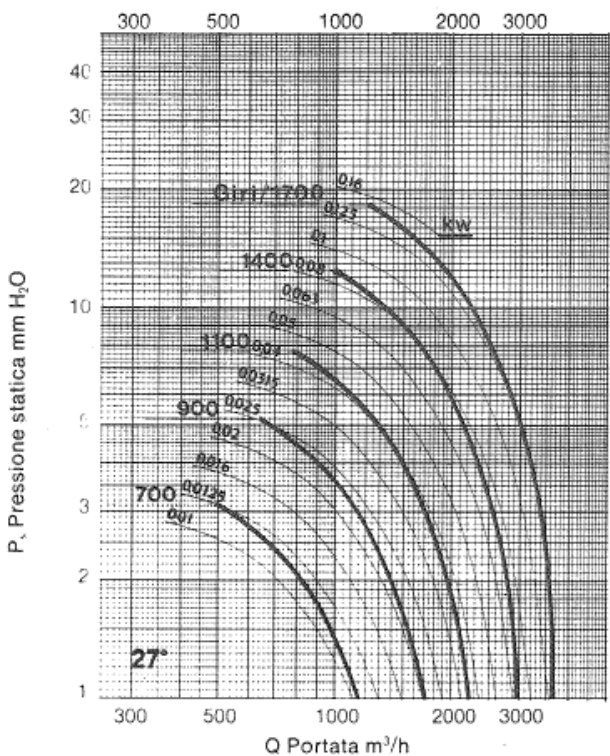
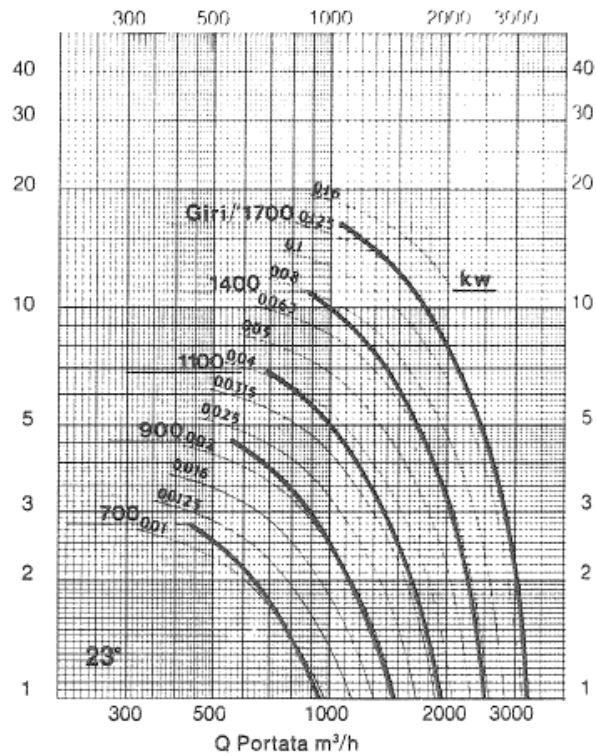
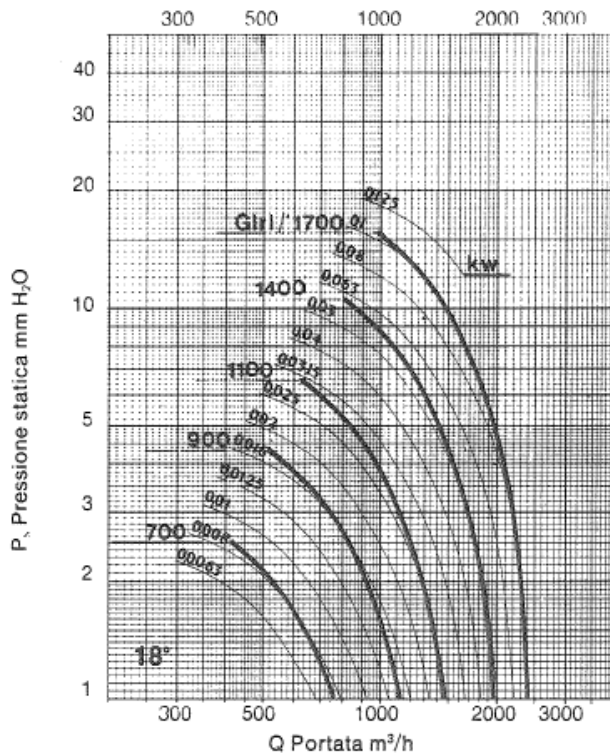

350



ISO 9001
Certificate N° 10-Q-10177-TIC

Ventilmotor S.r.l. a socio unico

Uffici e stabilimento: Via Piaggio, 74 - 20037 Paderno Dugnano (Mi) - **Sede Legale:** Via G. Pogliani, 34 - Paderno Dugnano (Mi)
Tel. +39 02.9101051 / +39 02.99041382 - Fax: +39 02.9103661 - info@ventilmotor.com - www.ventilmotor.com

Cap. Sociale € 10400,00 i.v. - REA 1519030 - N. Registro Imprese MI 53691 - Partita IVA 02632870966

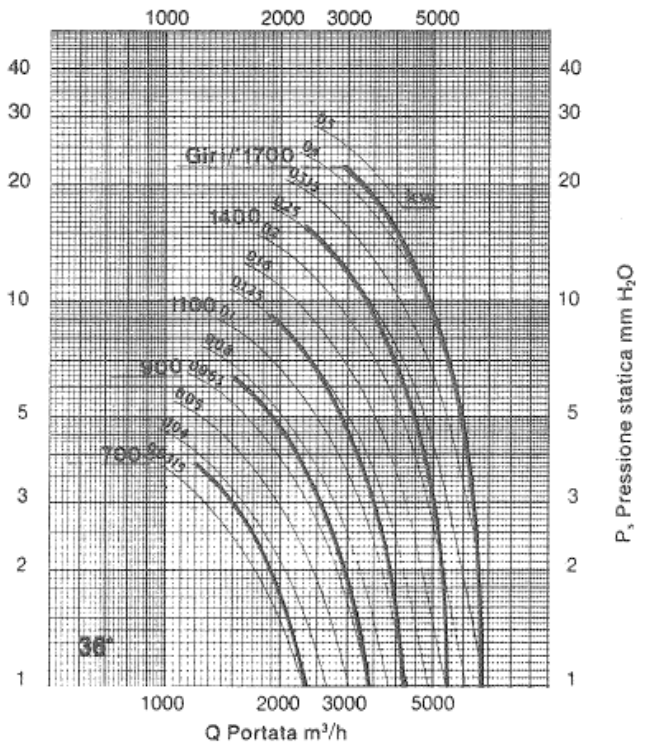
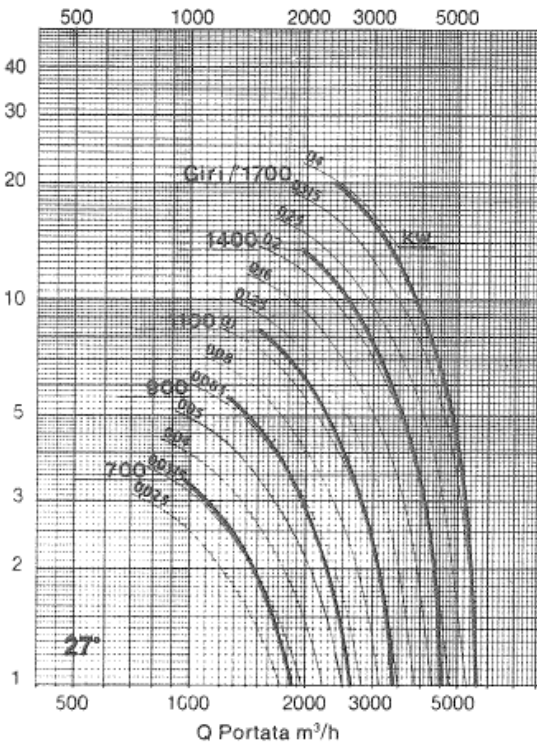
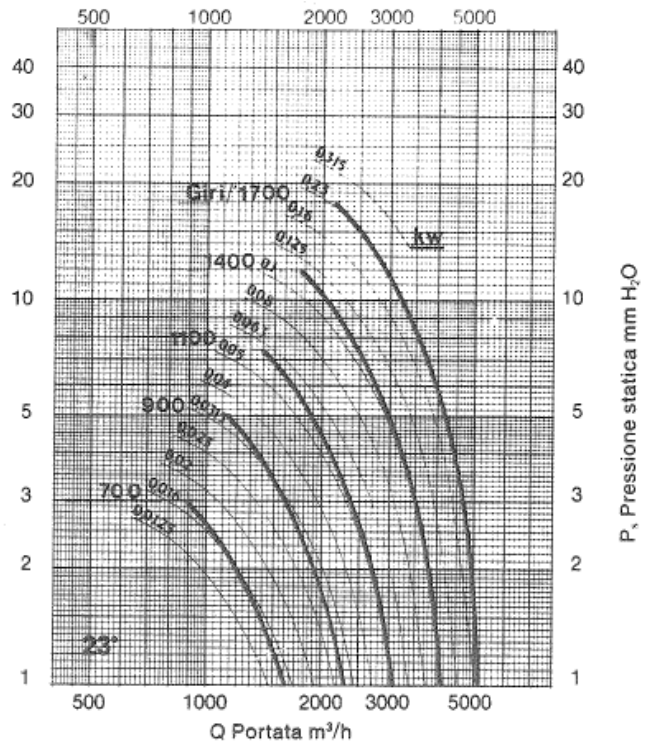
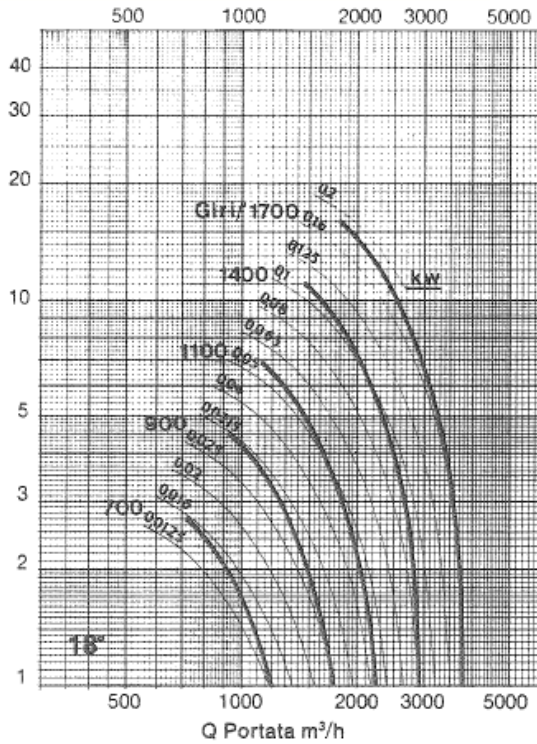

400



ISO 9001
Certificate N° 10-Q-10177-TIC

Ventilmotor S.r.l. a socio unico

Uffici e stabilimento: Via Piaggio, 74 - 20037 Paderno Dugnano (Mi) - **Sede Legale:** Via G. Pogliani, 34 - Paderno Dugnano (Mi)
Tel. +39 02.9101051 / +39 02.99041382 - Fax: +39 02.9103661 - info@ventilmotor.com - www.ventilmotor.com

Cap. Sociale € 10400,00 i.v. - REA 1519030 - N. Registro Imprese MI 53691 - Partita IVA 02632870966

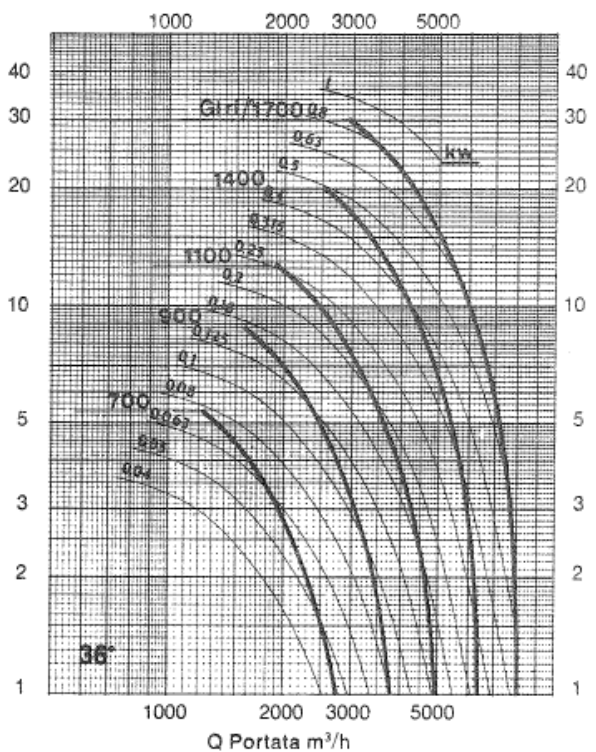
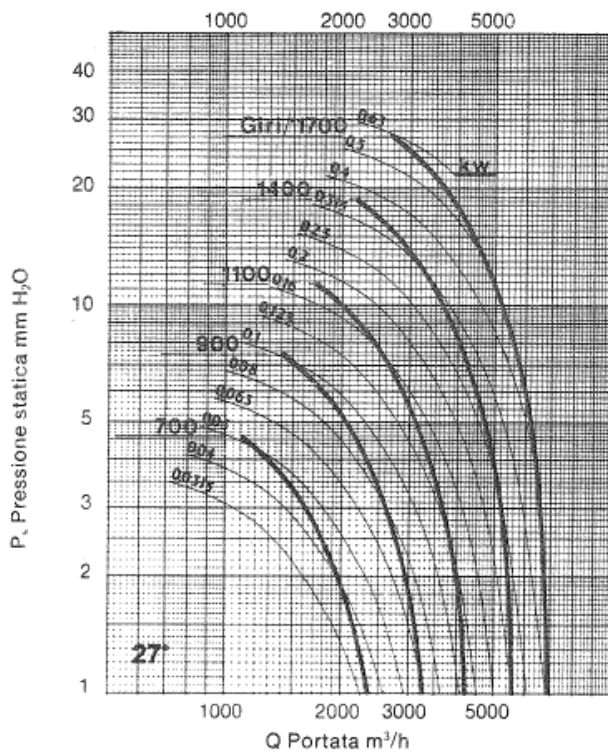
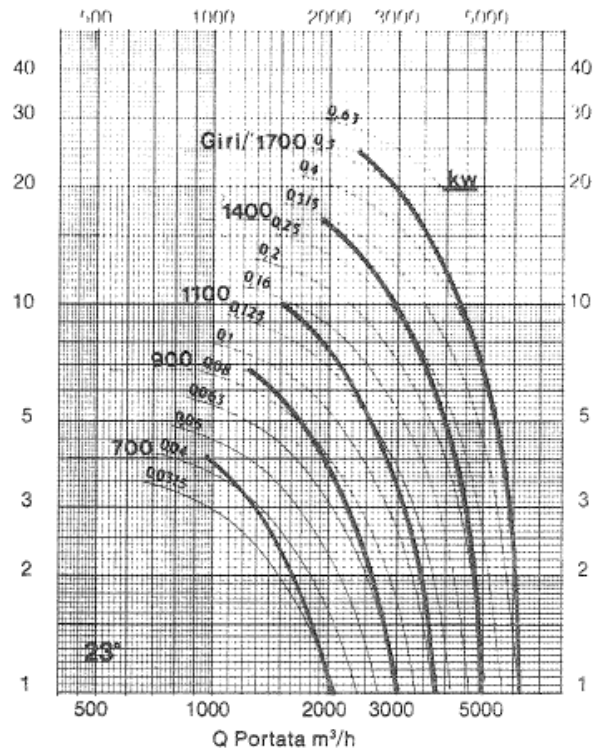
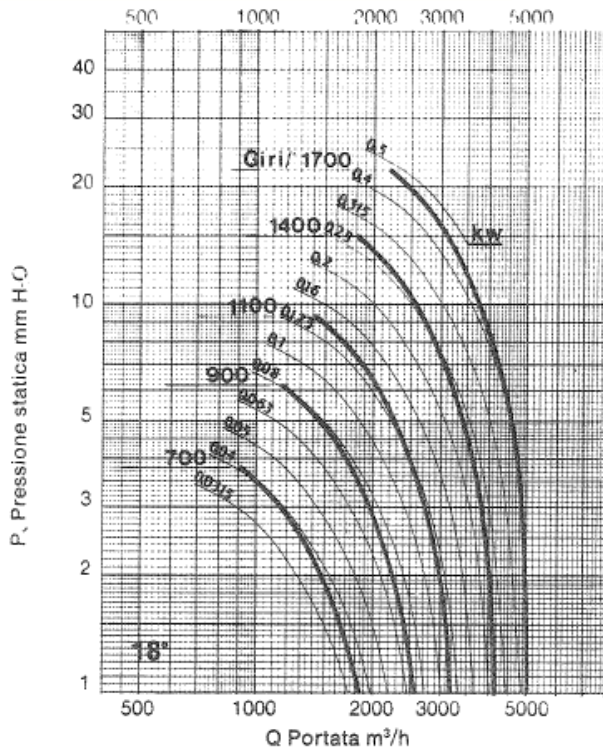

450



ISO 9001
Certificate N° 10-Q-10177-TIC

Ventilmotor S.r.l. a socio unico

Uffici e stabilimento: Via Piaggio, 74 - 20037 Paderno Dugnano (Mi) - **Sede Legale:** Via G. Pogliani, 34 - Paderno Dugnano (Mi)
Tel. +39 02.9101051 / +39 02.99041382 - Fax: +39 02.9103661 - info@ventilmotor.com - www.ventilmotor.com

Cap. Sociale € 10400,00 i.v. - REA 1519030 - N. Registro Imprese MI 53691 - Partita IVA 02632870966

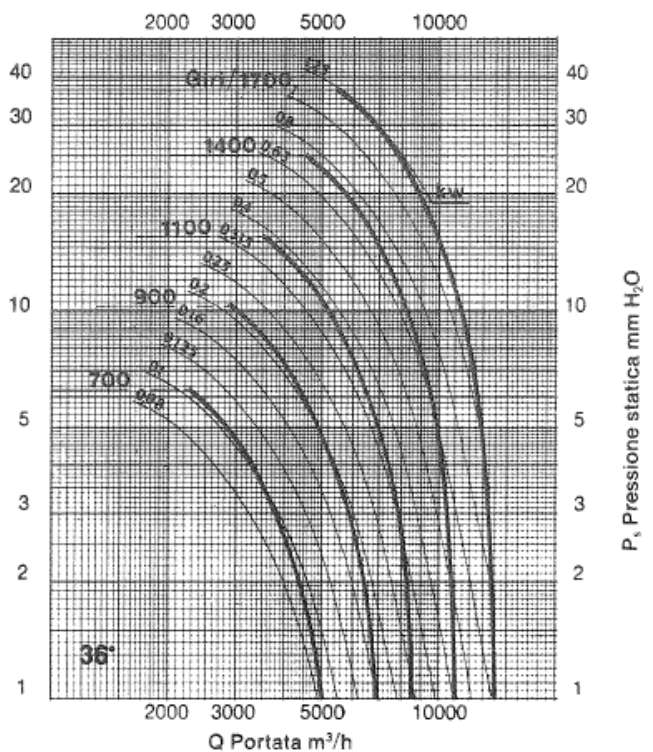
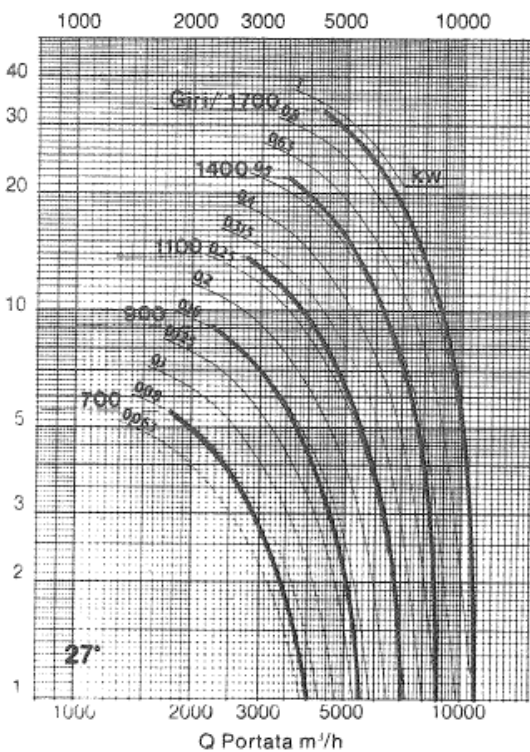
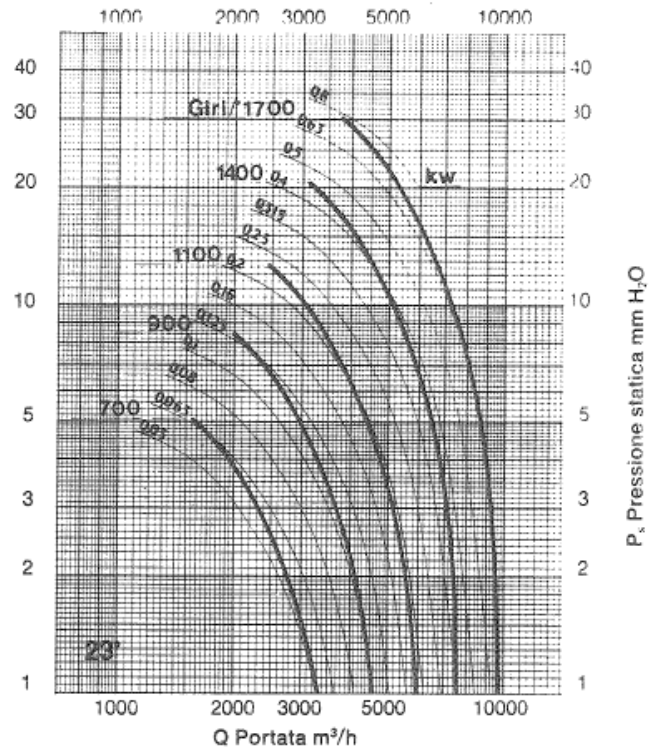
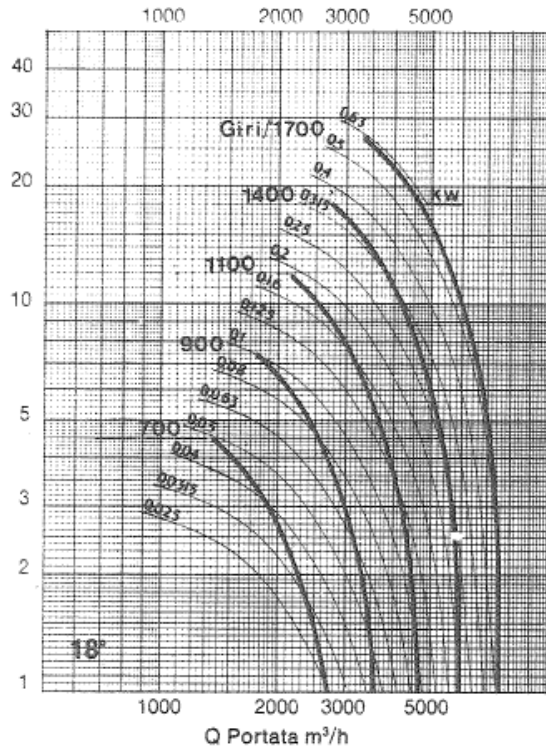

500



ISO 9001
Certificate N° 10-Q-10177-TIC

Ventilmotor S.r.l. a socio unico

Uffici e stabilimento: Via Piaggio, 74 - 20037 Paderno Dugnano (Mi) - **Sede Legale:** Via G. Pogliani, 34 - Paderno Dugnano (Mi)
Tel. +39 02.9101051 / +39 02.99041382 - Fax: +39 02.9103661 - info@ventilmotor.com - www.ventilmotor.com

Cap. Sociale € 10400,00 i.v. - REA 1519030 - N. Registro Imprese MI 53691 - Partita IVA 02632870966

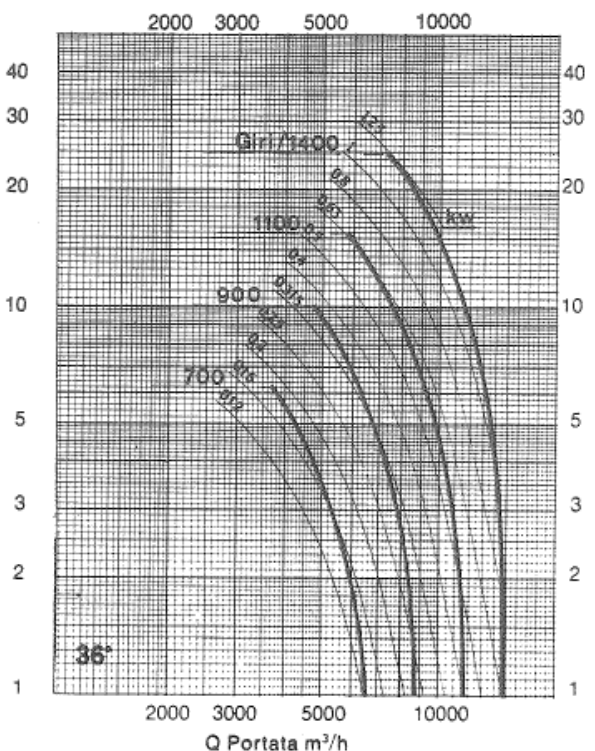
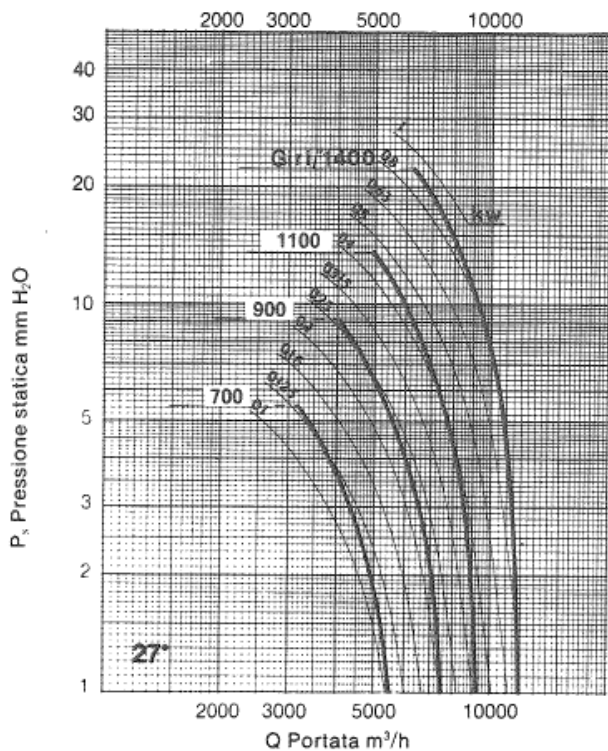
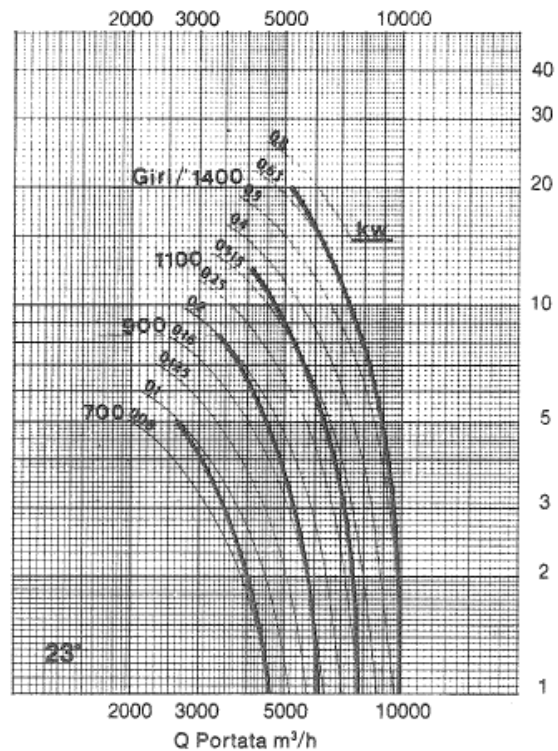
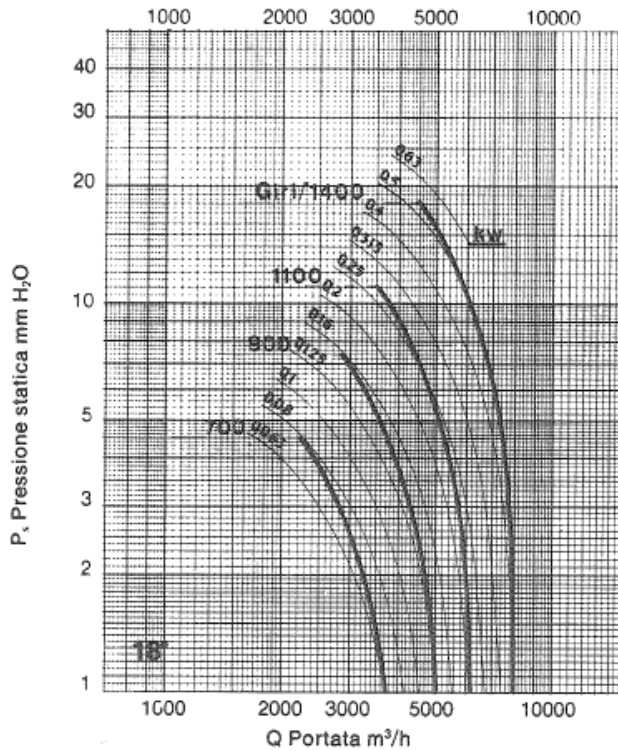

550



ISO 9001
Certificate N° 10-Q-10177-TIC

Ventilmotor S.r.l. a socio unico

Uffici e stabilimento: Via Piaggio, 74 - 20037 Paderno Dugnano (Mi) - **Sede Legale:** Via G. Pogliani, 34 - Paderno Dugnano (Mi)
Tel. +39 02.9101051 / +39 02.99041382 - Fax: +39 02.9103661 - info@ventilmotor.com - www.ventilmotor.com

Cap. Sociale € 10400,00 i.v. - REA 1519030 - N. Registro Imprese MI 53691 - Partita IVA 02632870966

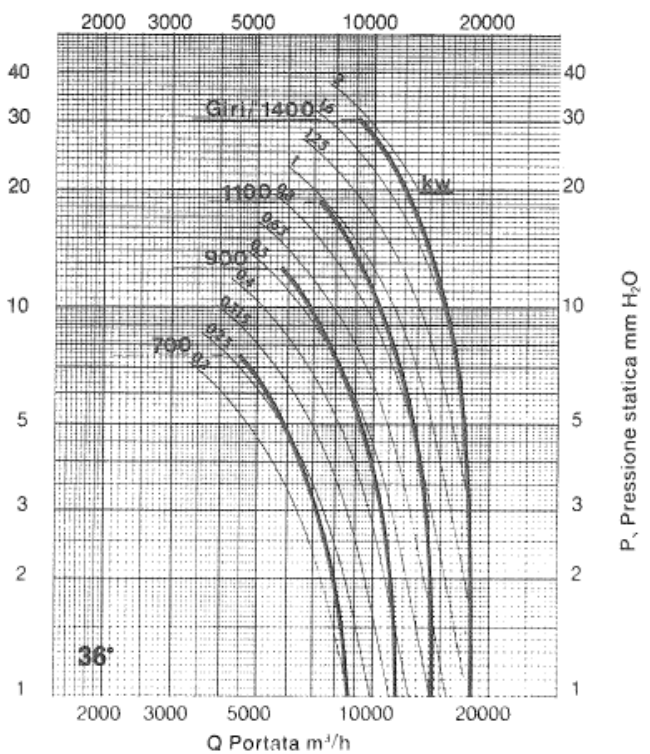
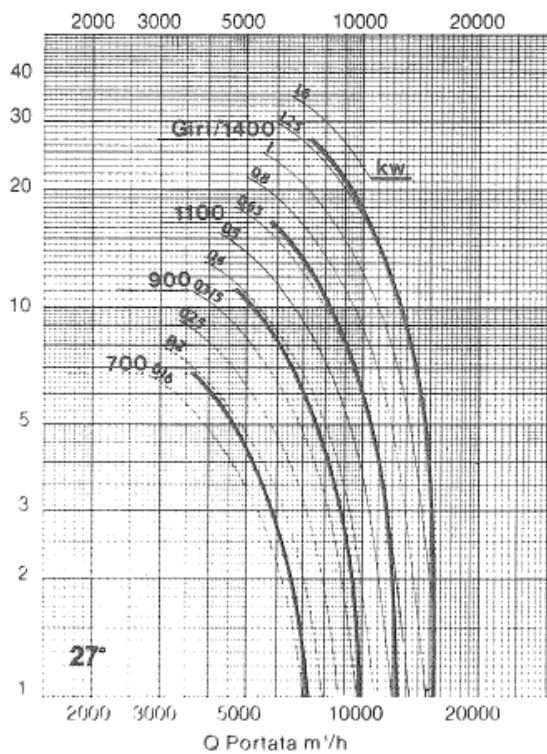
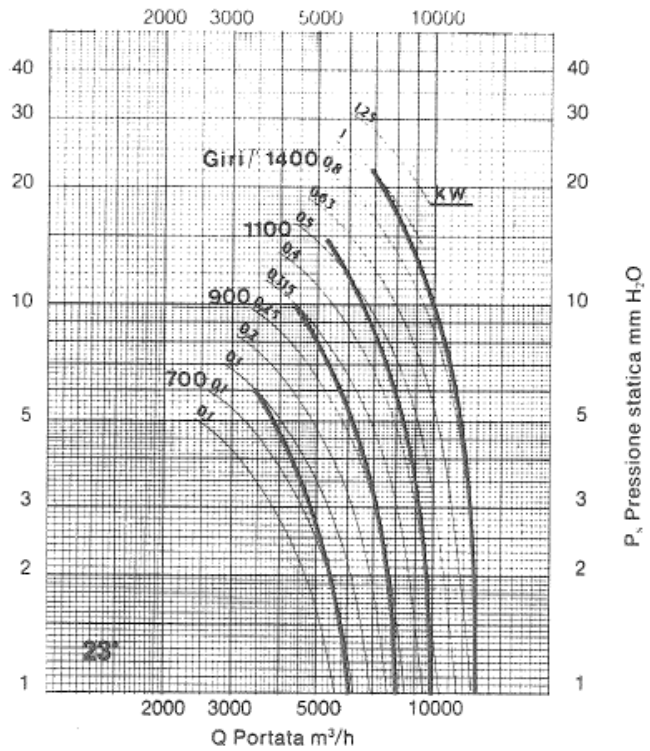
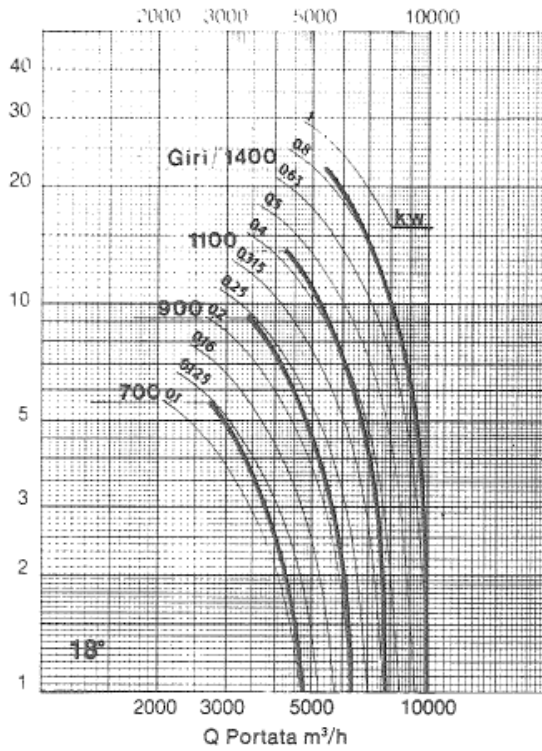

600



ISO 9001
Certificate N° 10-Q-10177-TIC

Ventilmotor S.r.l. a socio unico

Uffici e stabilimento: Via Piaggio, 74 - 20037 Paderno Dugnano (Mi) - **Sede Legale:** Via G. Pogliani, 34 - Paderno Dugnano (Mi)
Tel. +39 02.9101051 / +39 02.99041382 - Fax: +39 02.9103661 - info@ventilmotor.com - www.ventilmotor.com

Cap. Sociale € 10400,00 i.v. - REA 1519030 - N. Registro Imprese MI 53691 - Partita IVA 02632870966

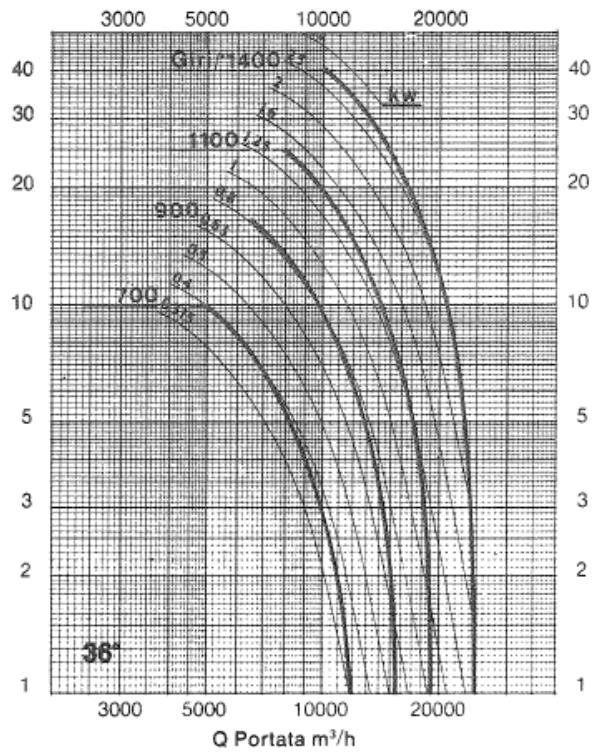
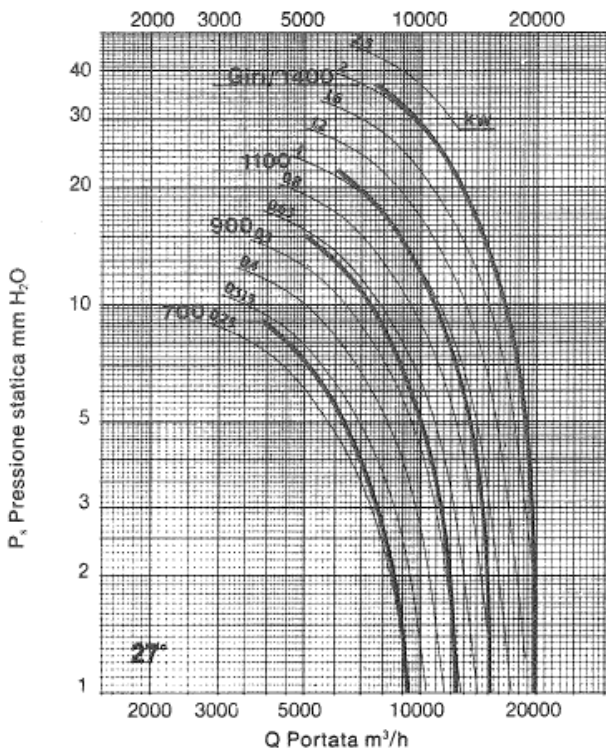
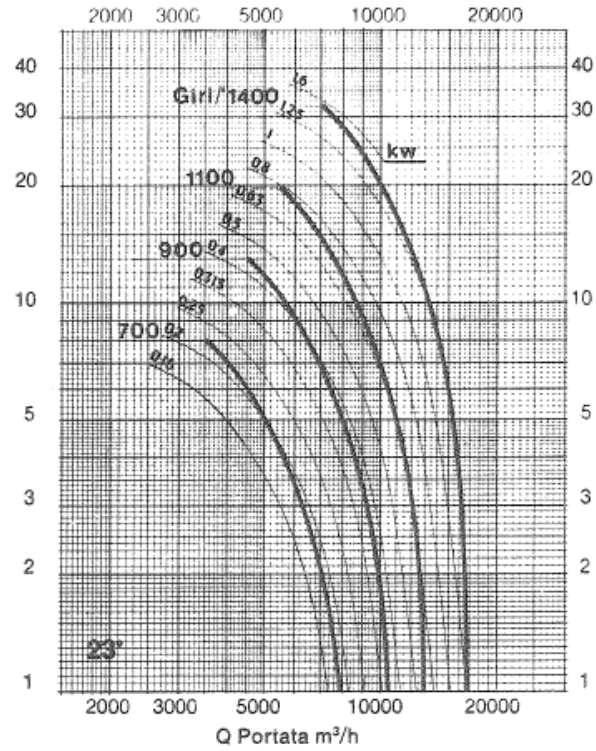
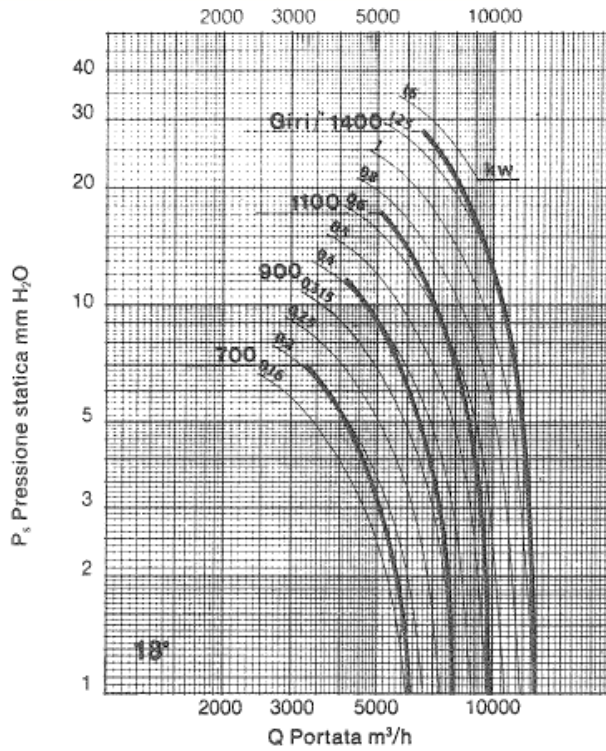

650



ISO 9001
Certificate N° 10-Q-10177-TIC

Ventilmotor S.r.l. a socio unico

Uffici e stabilimento: Via Piaggio, 74 - 20037 Paderno Dugnano (Mi) - **Sede Legale:** Via G. Pogliani, 34 - Paderno Dugnano (Mi)
Tel. +39 02.9101051 / +39 02.99041382 - Fax: +39 02.9103661 - info@ventilmotor.com - www.ventilmotor.com

Cap. Sociale € 10400,00 i.v. - REA 1519030 - N. Registro Imprese MI 53691 - Partita IVA 02632870966

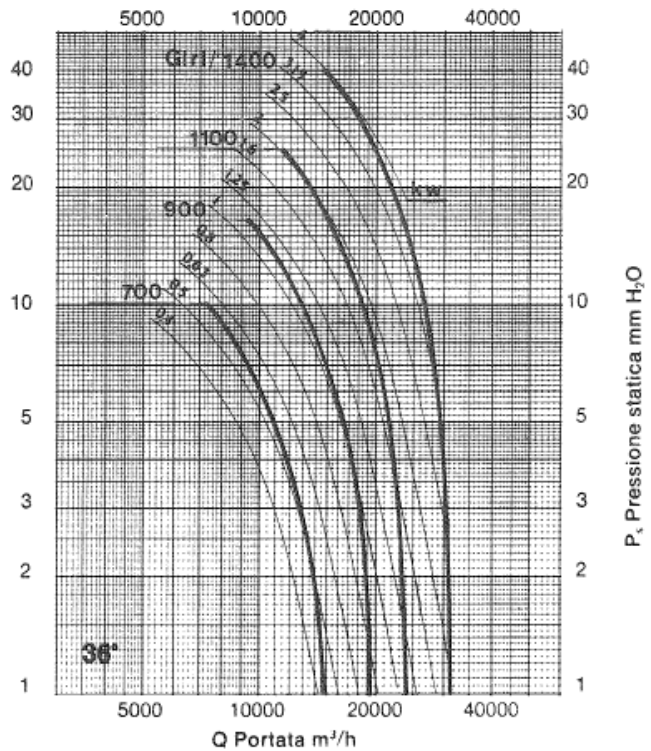
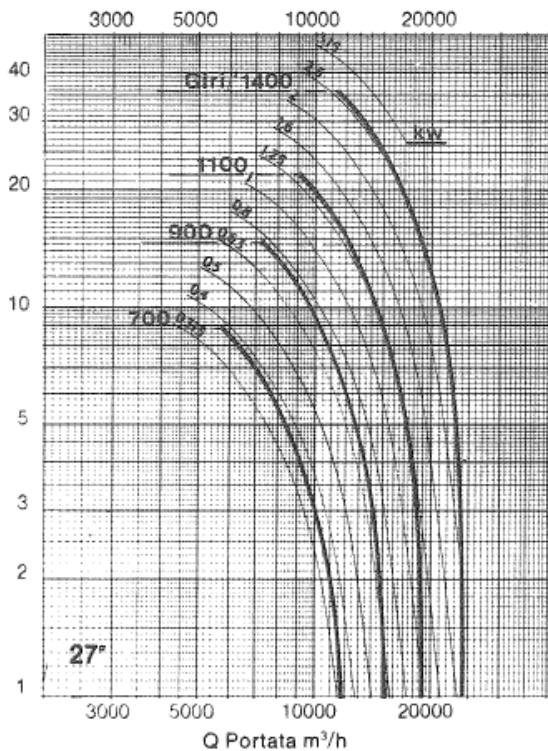
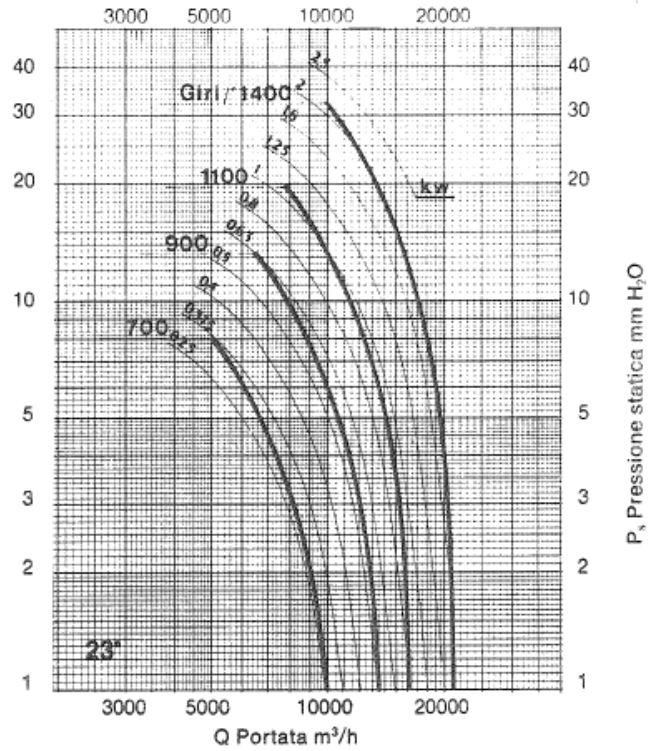
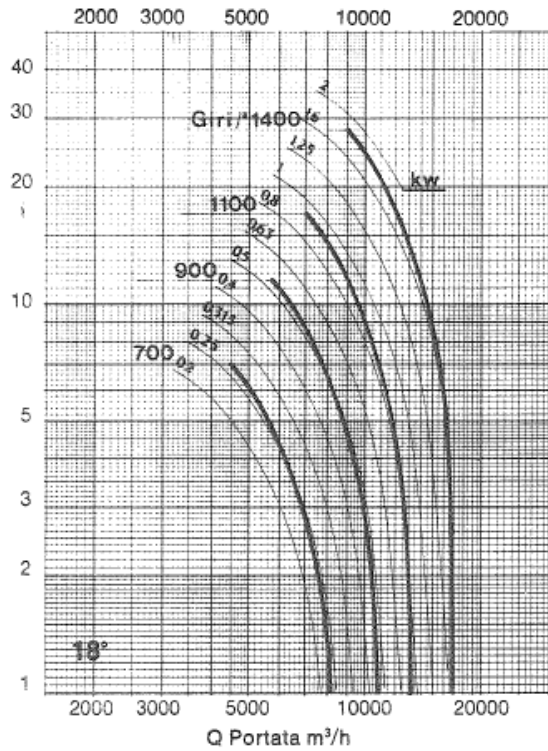

700



ISO 9001
Certificate N° 10-Q-10177-TIC

Ventilmotor S.r.l. a socio unico

Uffici e stabilimento: Via Piaggio, 74 - 20037 Paderno Dugnano (Mi) - **Sede Legale:** Via G. Pogliani, 34 - Paderno Dugnano (Mi)
Tel. +39 02.9101051 / +39 02.99041382 - Fax: +39 02.9103661 - info@ventilmotor.com - www.ventilmotor.com

Cap. Sociale € 10400,00 i.v. - REA 1519030 - N. Registro Imprese MI 53691 - Partita IVA 02632870966

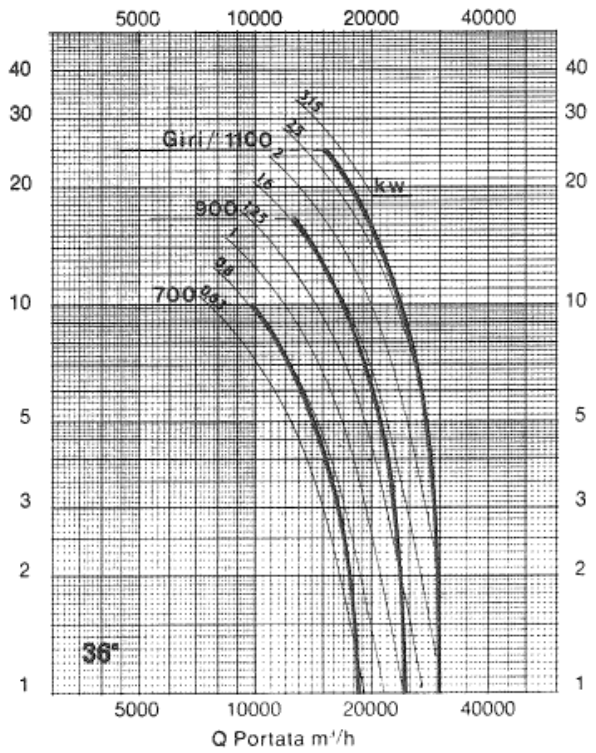
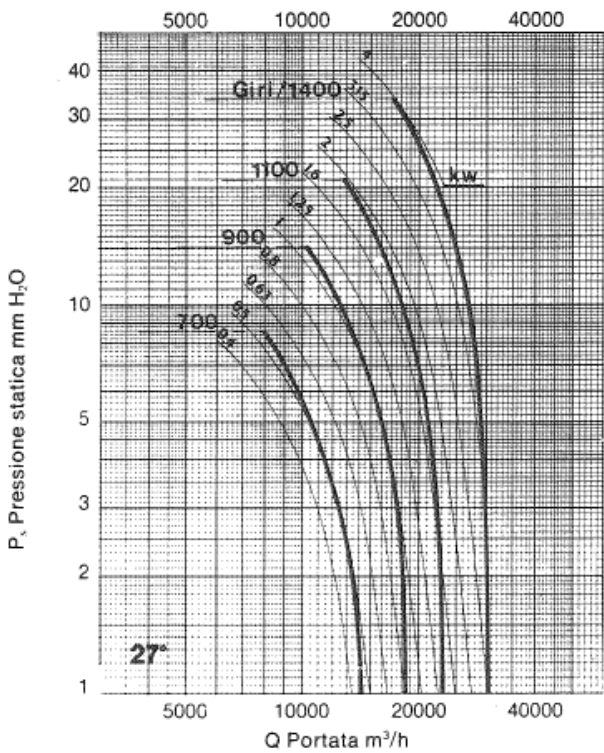
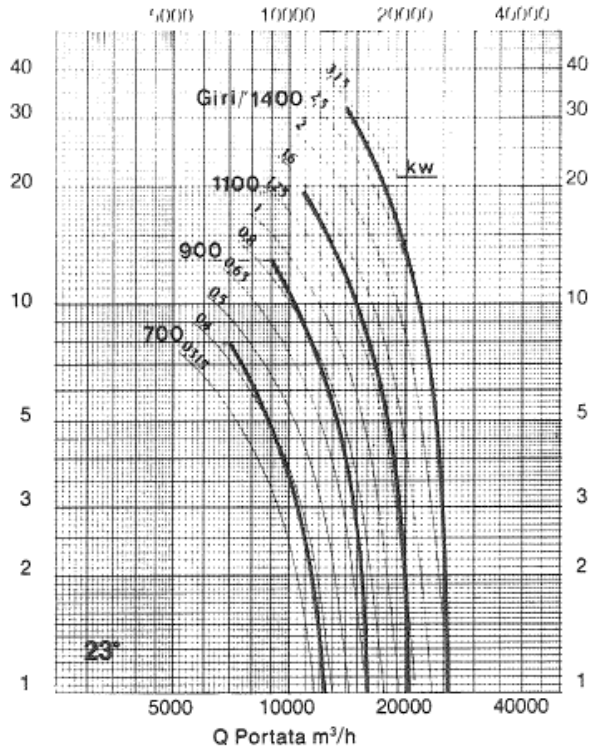
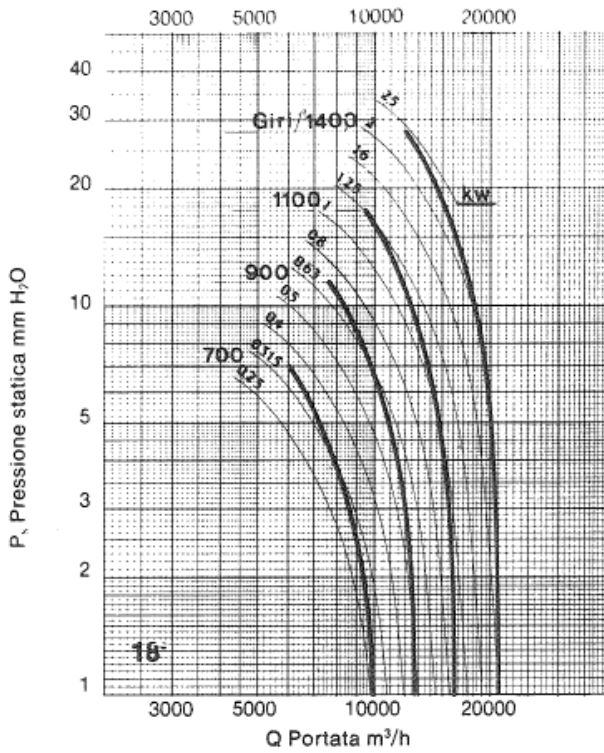

750



ISO 9001
Certificate N° 10-Q-10177-TIC

Ventilmotor S.r.l. a socio unico

Uffici e stabilimento: Via Piaggio, 74 - 20037 Paderno Dugnano (Mi) - **Sede Legale:** Via G. Pogliani, 34 - Paderno Dugnano (Mi)
Tel. +39 02.9101051 / +39 02.99041382 - Fax: +39 02.9103661 - info@ventilmotor.com - www.ventilmotor.com

Cap. Sociale € 10400,00 i.v. - REA 1519030 - N. Registro Imprese MI 53691 - Partita IVA 02632870966