

Ventole Elicoidali F6

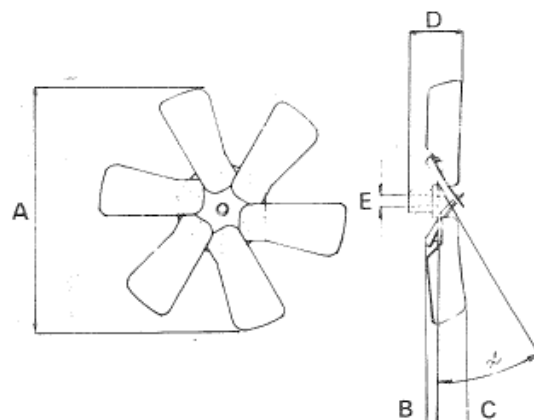
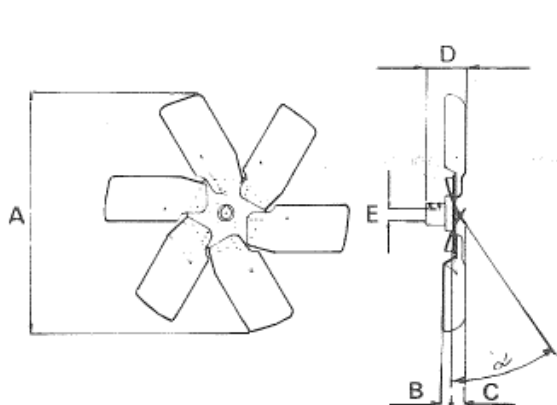

| F6 | kg | A | α° | B | C |
|-----|-----|-----|----------------|----|----|
| 500 | 3.2 | 500 | 20 | 15 | 38 |
| | | | 30 | 27 | 48 |
| | | | 39 | 40 | 50 |
| 550 | 3.6 | 550 | 20 | 15 | 38 |
| | | | 30 | 27 | 48 |
| | | | 39 | 40 | 50 |
| 600 | 4 | 600 | 20 | 15 | 38 |
| | | | 30 | 27 | 48 |
| | | | 39 | 40 | 50 |
| 650 | 4.2 | 650 | 20 | 15 | 38 |
| | | | 30 | 27 | 48 |
| | | | 39 | 40 | 50 |
| 700 | 4.5 | 700 | 20 | 15 | 38 |
| | | | 30 | 27 | 48 |
| | | | 39 | 40 | 50 |
| 750 | 4.8 | 750 | 20 | 15 | 38 |
| | | | 30 | 26 | 48 |
| | | | 39 | 40 | 50 |
| 800 | 5 | 800 | 20 | 23 | 50 |
| | | | 30 | 27 | 48 |
| | | | 39 | 33 | 46 |

| F6S | kg | A | α° | B | C |
|------|-----|------|----------------|----|----|
| 850 | 8.5 | 850 | 14 | 10 | 40 |
| | | | 20 | 22 | 68 |
| | | | 27 | 32 | 88 |
| 900 | 9 | 900 | 14 | 10 | 40 |
| | | | 20 | 22 | 68 |
| | | | 27 | 41 | 54 |
| 950 | 10 | 950 | 14 | 10 | 40 |
| | | | 20 | 22 | 68 |
| | | | 27 | 32 | 88 |
| 1000 | 11 | 1000 | 14 | 10 | 45 |
| | | | 20 | 22 | 53 |
| | | | 27 | 27 | 98 |
| 1100 | 12 | 1100 | 14 | 10 | 45 |
| | | | 20 | 24 | 52 |
| | | | 27 | 27 | 98 |
| 1235 | 17 | 1235 | 14 | 10 | 45 |
| | | | 20 | 22 | 63 |
| | | | 27 | 34 | 65 |
| 1370 | 20 | 1370 | 14 | 24 | 46 |
| | | | 20 | 22 | 68 |
| | | | 27 | 40 | 60 |
| 1500 | 33 | 1500 | 14 | 10 | 45 |
| | | | 20 | 22 | 68 |
| | | | 27 | 27 | 98 |

Le quote D ed E dipendono dal tipo di mozzo montato (vedere prospetto mozzi).



ISO 9001
 Certificate N° 10-Q-10177-TIC

Ventilmotor S.r.l. a socio unico

Uffici e stabilimento: Via Piaggio, 74 - 20037 Paderno Dugnano (Mi) - **Sede Legale:** Via G. Pogliani, 34 - Paderno Dugnano (Mi)

Tel. +39 02.9101051 / +39 02.99041382 - Fax: +39 02.9103661 - info@ventilmotor.com - www.ventilmotor.com

Cap. Sociale € 10400,00 i.v. - REA 1519030 - N. Registro Imprese MI 53691 - Partita IVA 02632870966

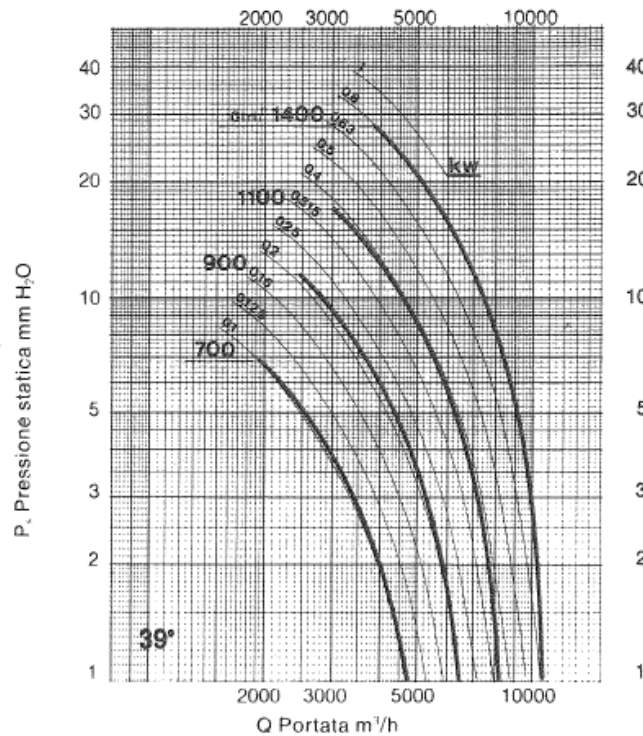
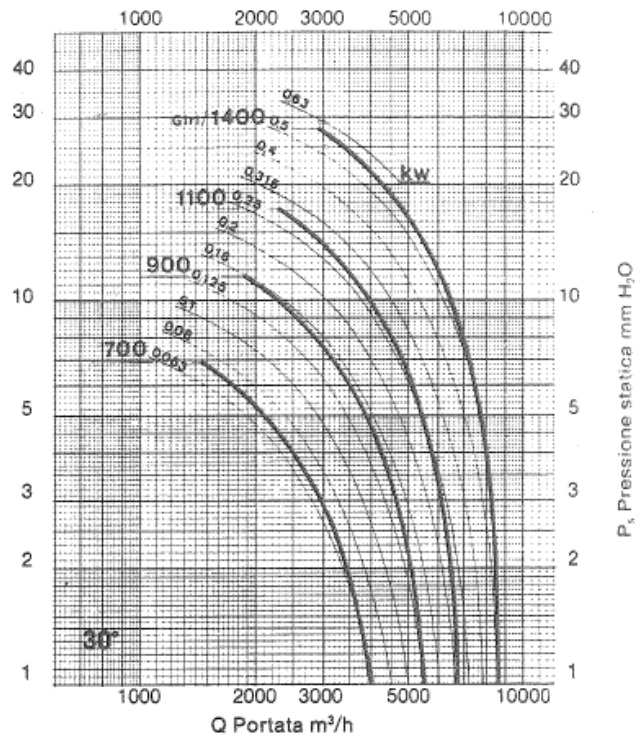
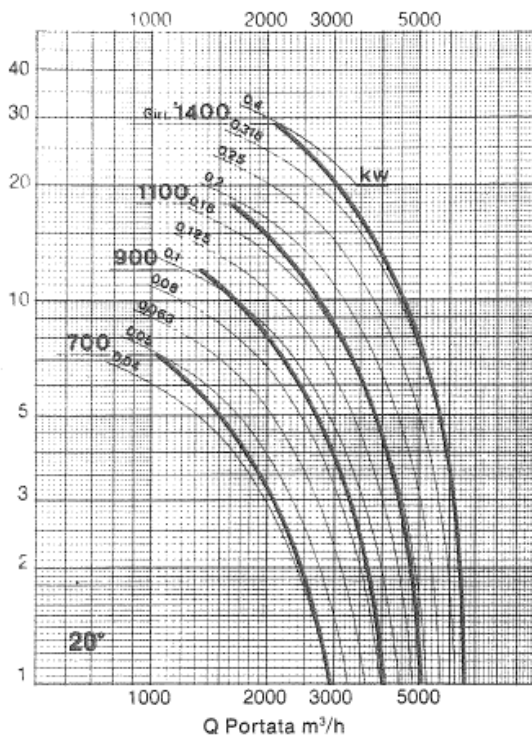

500



ISO 9001
Certificate N° 10-Q-10177-TIC

Ventilmotor S.r.l. a socio unico

Uffici e stabilimento: Via Piaggio, 74 - 20037 Paderno Dugnano (Mi) - **Sede Legale:** Via G. Pogliani, 34 - Paderno Dugnano (Mi)
Tel. +39 02.9101051 / +39 02.99041382 - Fax: +39 02.9103661 - info@ventilmotor.com - www.ventilmotor.com

Cap. Sociale € 10400,00 i.v. - REA 1519030 - N. Registro Imprese MI 53691 - Partita IVA 02632870966

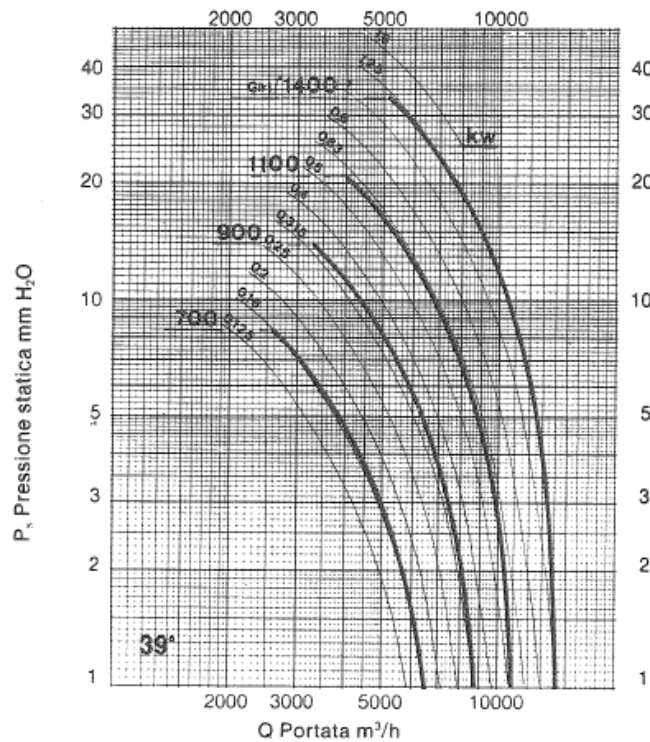
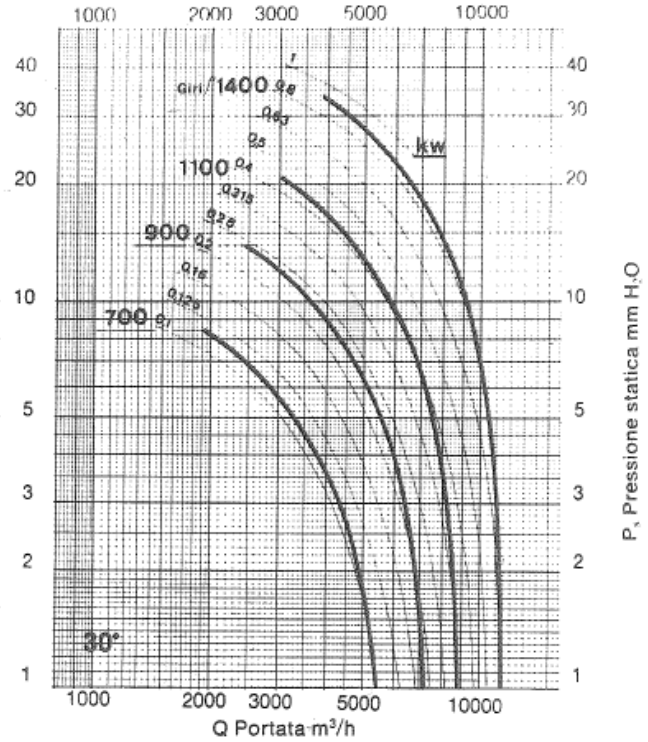
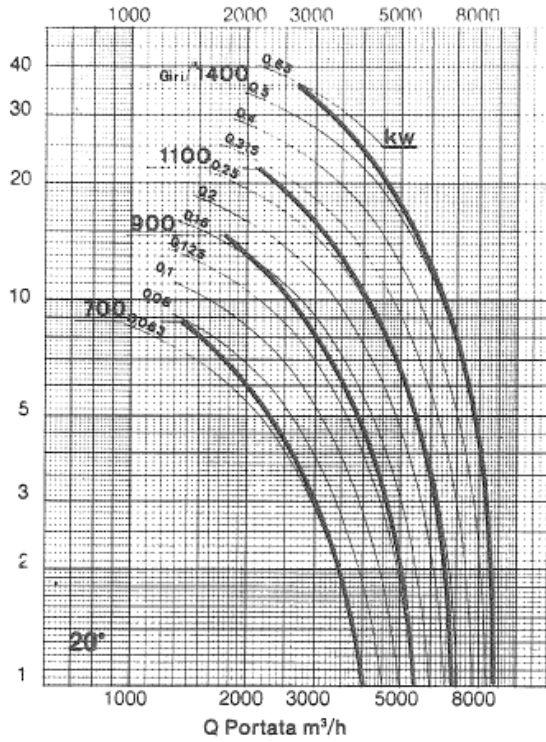

550

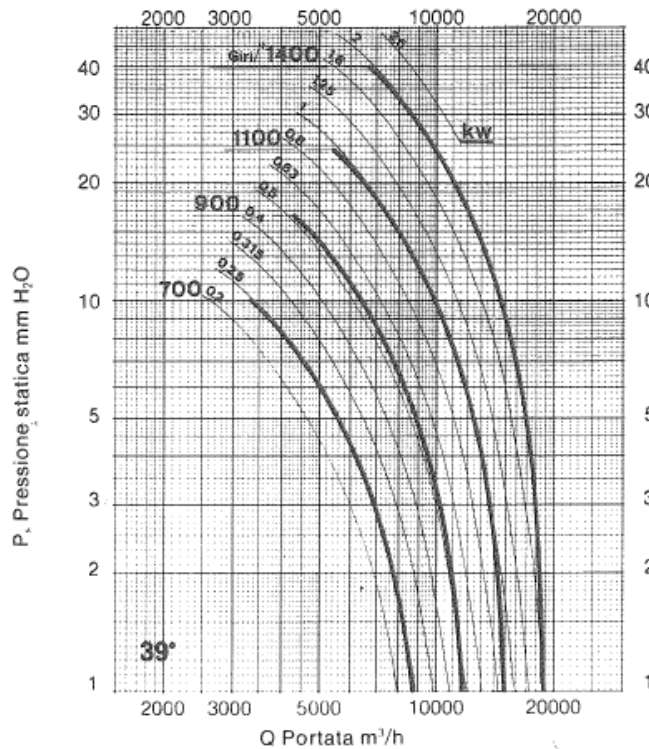
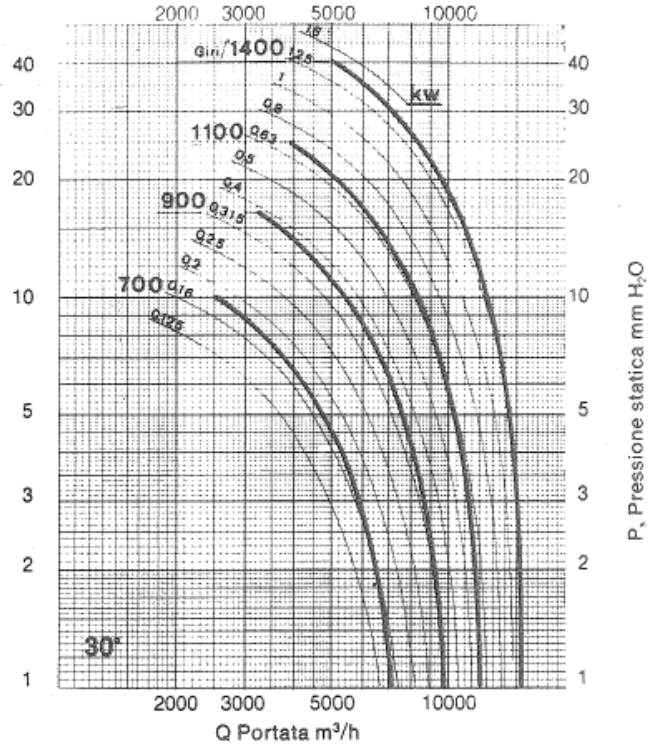
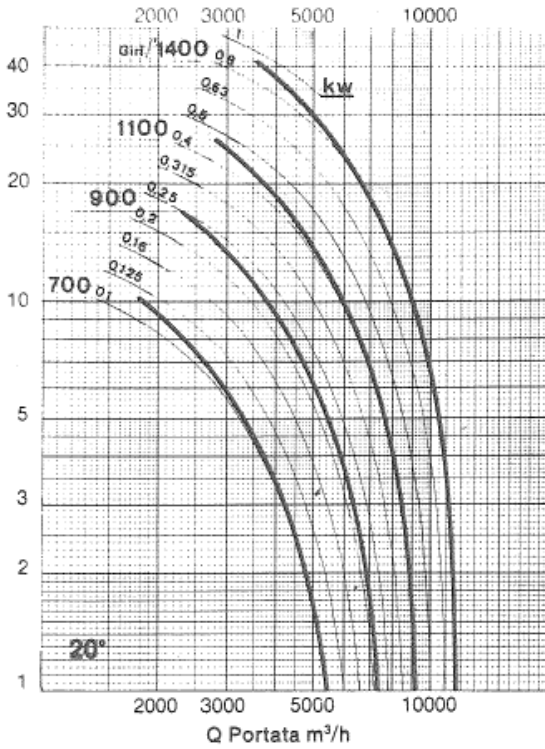

600



ISO 9001
Certificate N° 10-Q-10177-TIC

Ventilmotor S.r.l. a socio unico

Uffici e stabilimento: Via Piaggio, 74 - 20037 Paderno Dugnano (Mi) - **Sede Legale:** Via G. Pogliani, 34 - Paderno Dugnano (Mi)
Tel. +39 02.9101051 / +39 02.99041382 - Fax: +39 02.9103661 - info@ventilmotor.com - www.ventilmotor.com

Cap. Sociale € 10400,00 i.v. - REA 1519030 - N. Registro Imprese MI 53691 - Partita IVA 02632870966

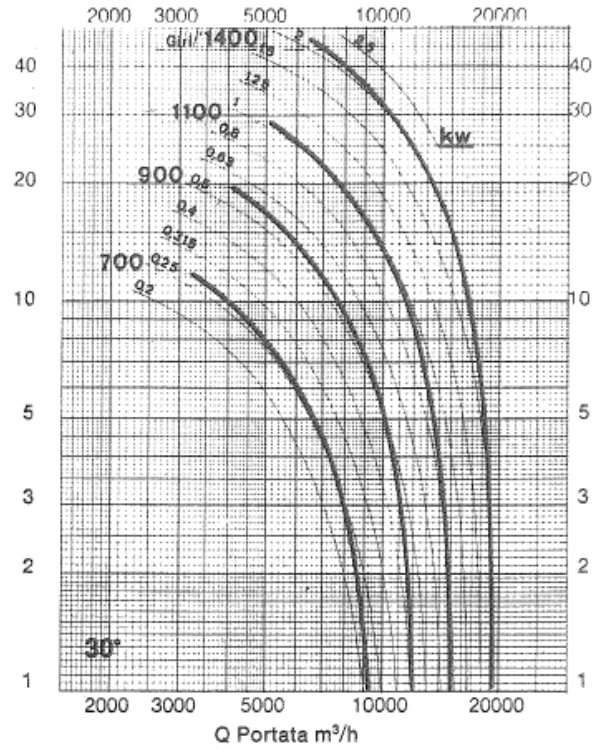
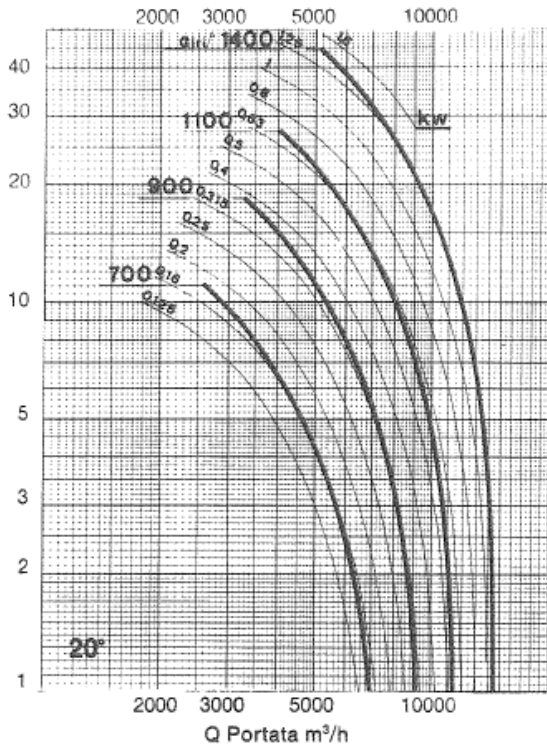

P_s Pressione statica mm H₂O

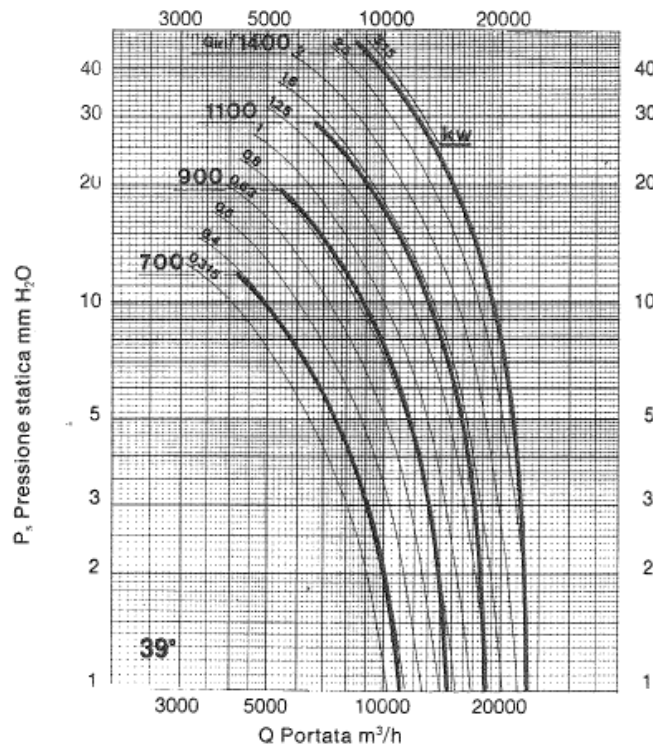

650



ISO 9001
Certificate N° 10-Q-10177-TIC

Ventilmotor S.r.l. a socio unico

Uffici e stabilimento: Via Piaggio, 74 - 20037 Paderno Dugnano (Mi) - **Sede Legale:** Via G. Pogliani, 34 - Paderno Dugnano (Mi)
Tel. +39 02.9101051 / +39 02.99041382 - Fax: +39 02.9103661 - info@ventilmotor.com - www.ventilmotor.com

Cap. Sociale € 10400,00 i.v. - REA 1519030 - N. Registro Imprese MI 53691 - Partita IVA 02632870966

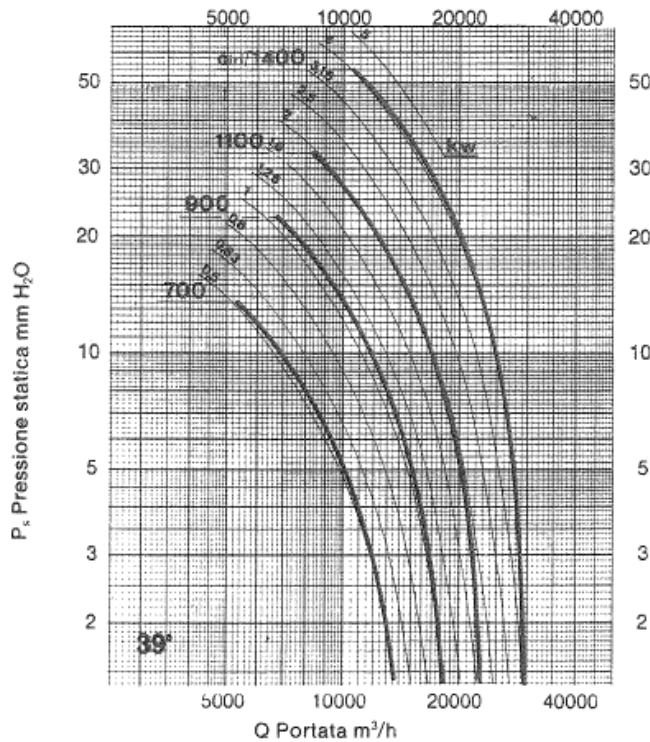
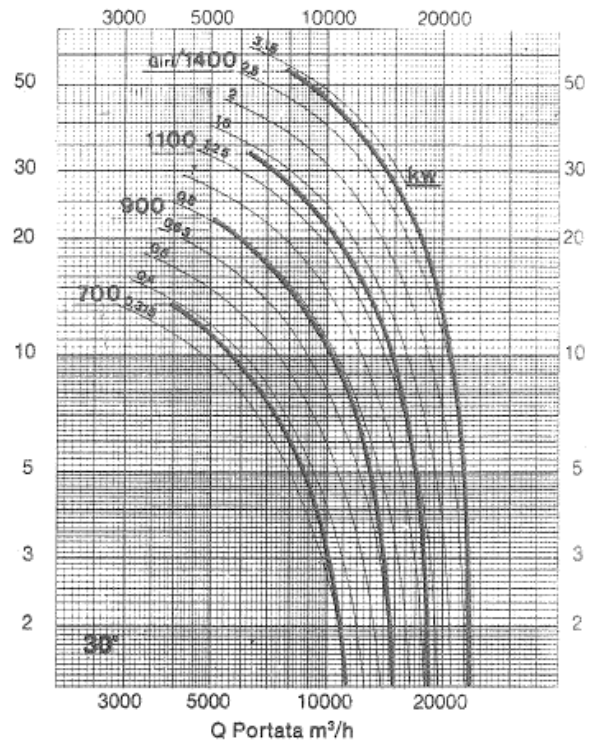
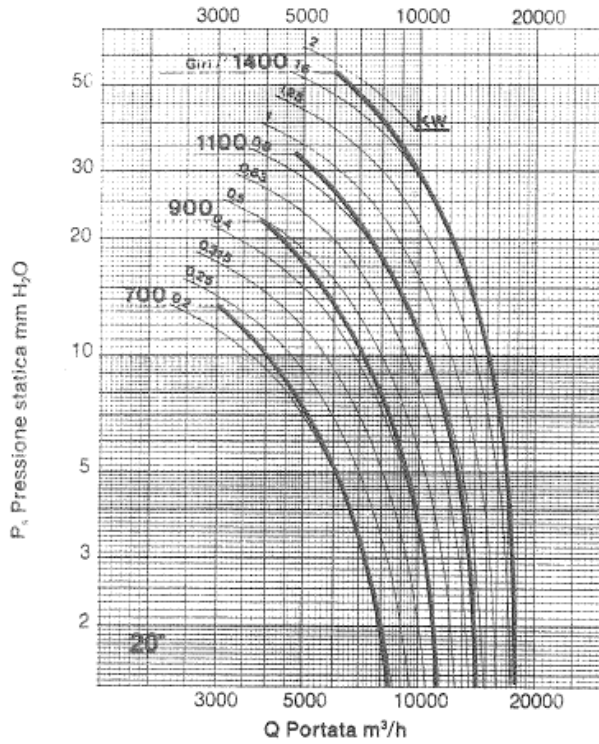

700



ISO 9001
Certificate N° 10-Q-10177-TIC

Ventilmotor S.r.l. a socio unico

Uffici e stabilimento: Via Piaggio, 74 - 20037 Paderno Dugnano (Mi) - **Sede Legale:** Via G. Pogliani, 34 - Paderno Dugnano (Mi)
Tel. +39 02.9101051 / +39 02.99041382 - Fax: +39 02.9103661 - info@ventilmotor.com - www.ventilmotor.com

Cap. Sociale € 10400,00 i.v. - REA 1519030 - N. Registro Imprese MI 53691 - Partita IVA 02632870966

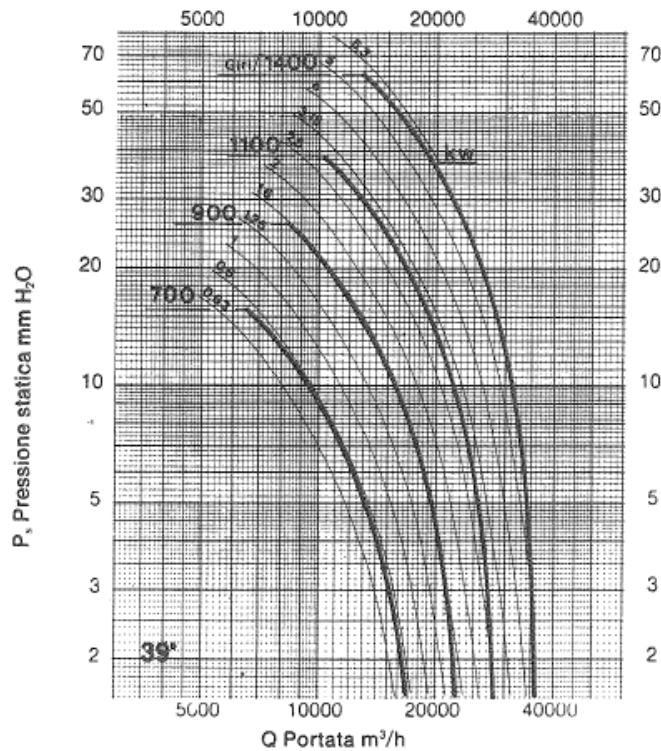
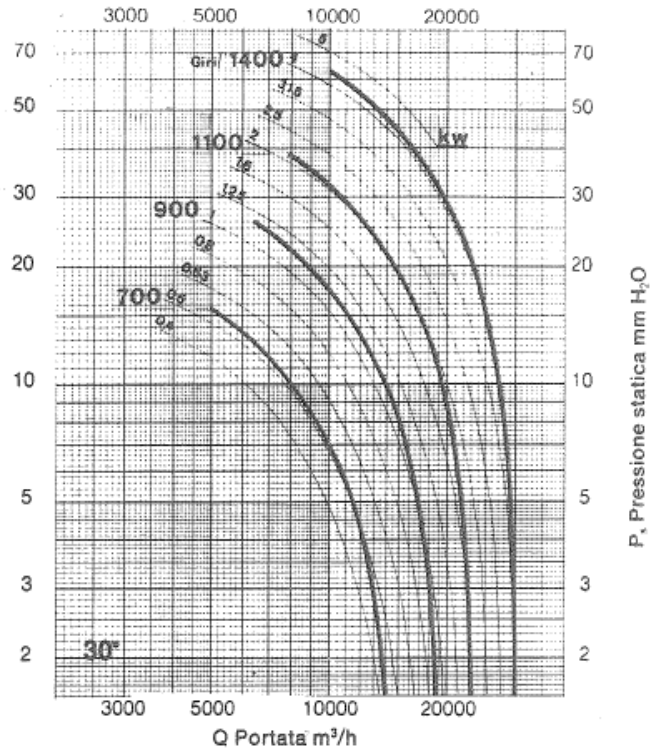
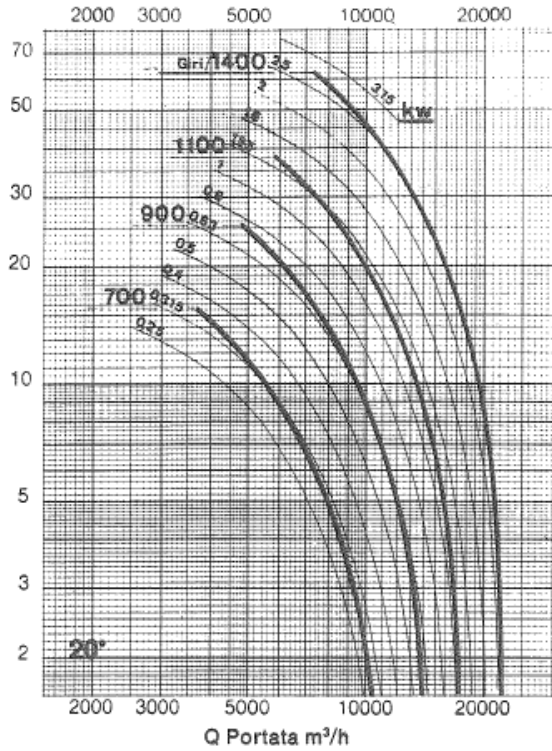

750



ISO 9001
Certificate N° 10-Q-10177-TIC

Ventilmotor S.r.l. a socio unico

Uffici e stabilimento: Via Piaggio, 74 - 20037 Paderno Dugnano (Mi) - **Sede Legale:** Via G. Pogliani, 34 - Paderno Dugnano (Mi)
Tel. +39 02.9101051 / +39 02.99041382 - Fax: +39 02.9103661 - info@ventilmotor.com - www.ventilmotor.com

Cap. Sociale € 10400,00 i.v. - REA 1519030 - N. Registro Imprese MI 53691 - Partita IVA 02632870966

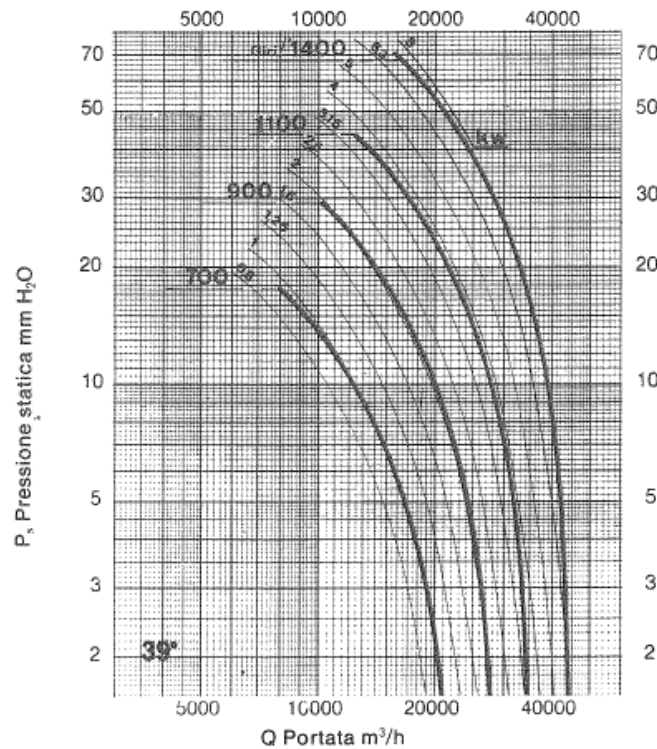
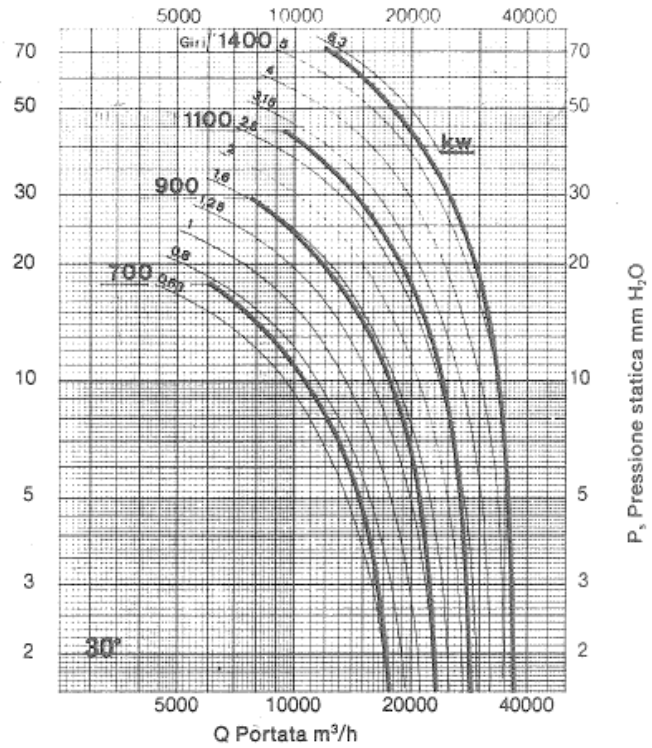
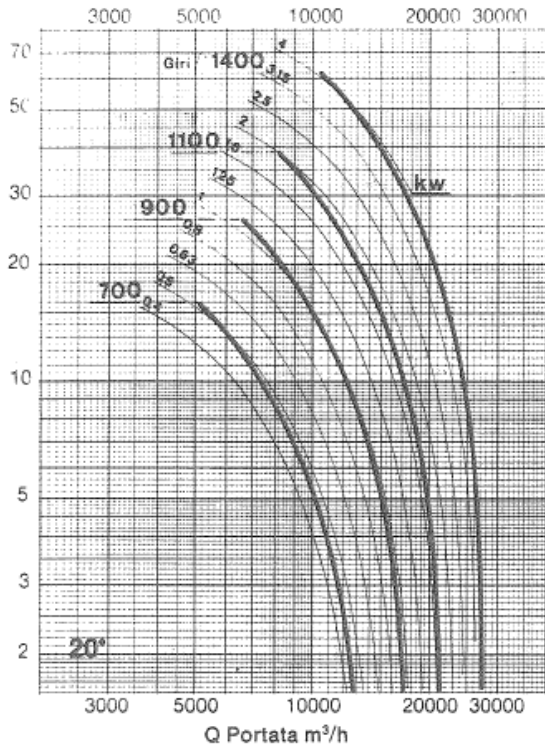

800



ISO 9001
Certificate N° 10-Q-10177-TIC

Ventilmotor S.r.l. a socio unico

Uffici e stabilimento: Via Piaggio, 74 - 20037 Paderno Dugnano (Mi) - **Sede Legale:** Via G. Pogliani, 34 - Paderno Dugnano (Mi)
Tel. +39 02.9101051 / +39 02.99041382 - Fax: +39 02.9103661 - info@ventilmotor.com - www.ventilmotor.com

Cap. Sociale € 10400,00 i.v. - REA 1519030 - N. Registro Imprese MI 53691 - Partita IVA 02632870966

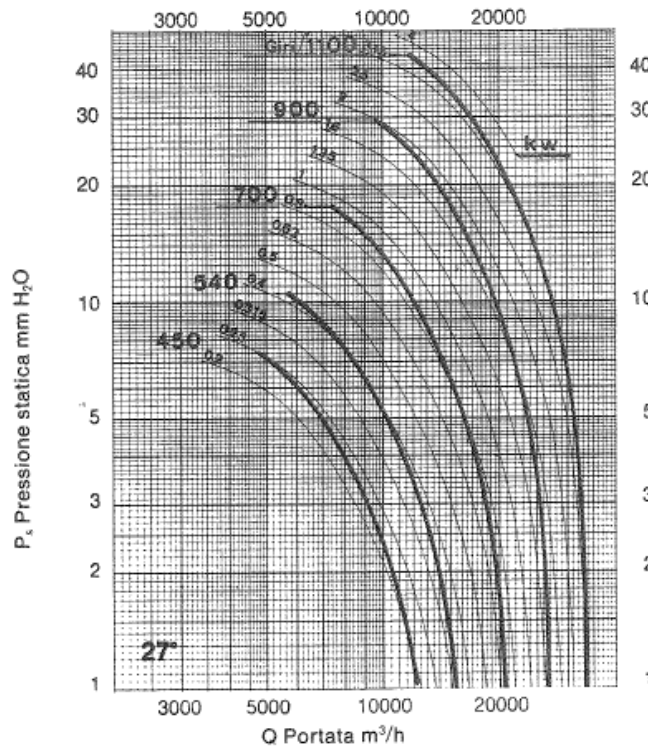
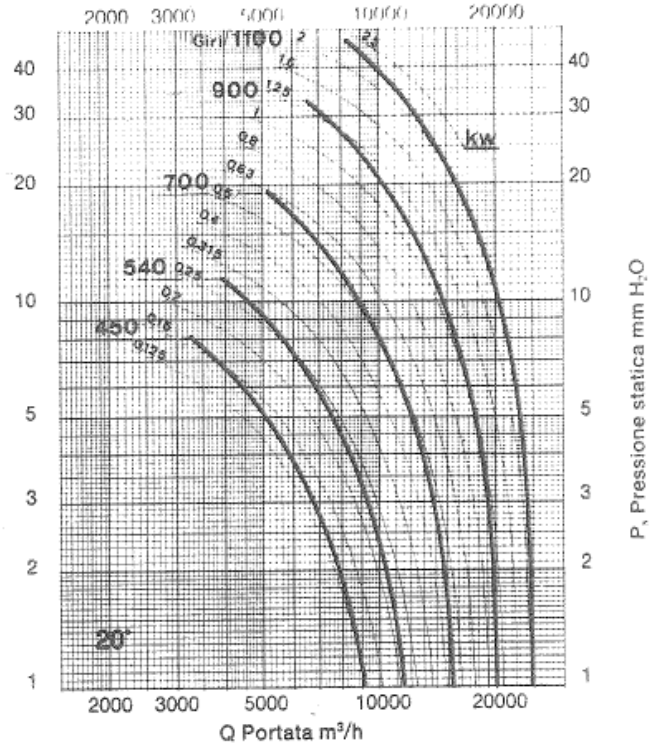
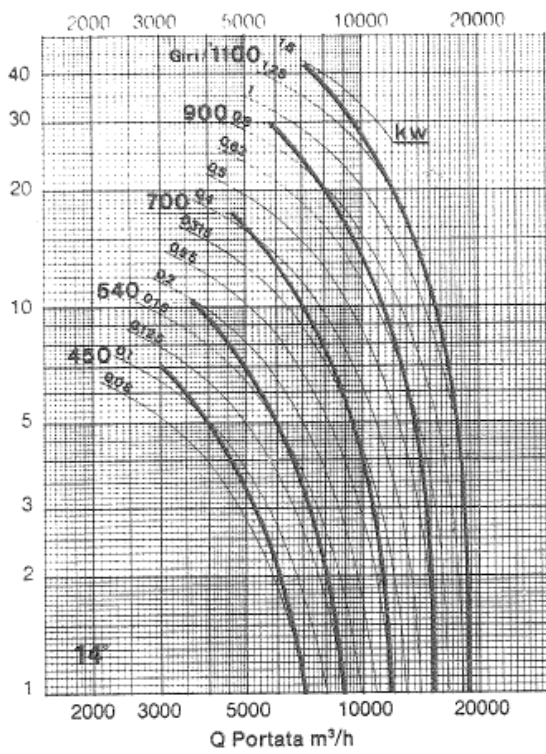

850



ISO 9001
Certificate N° 10-Q-10177-TIC

Ventilmotor S.r.l. a socio unico

Uffici e stabilimento: Via Piaggio, 74 - 20037 Paderno Dugnano (Mi) - **Sede Legale:** Via G. Pogliani, 34 - Paderno Dugnano (Mi)
Tel. +39 02.9101051 / +39 02.99041382 - Fax: +39 02.9103661 - info@ventilmotor.com - www.ventilmotor.com

Cap. Sociale € 10400,00 i.v. - REA 1519030 - N. Registro Imprese MI 53691 - Partita IVA 02632870966

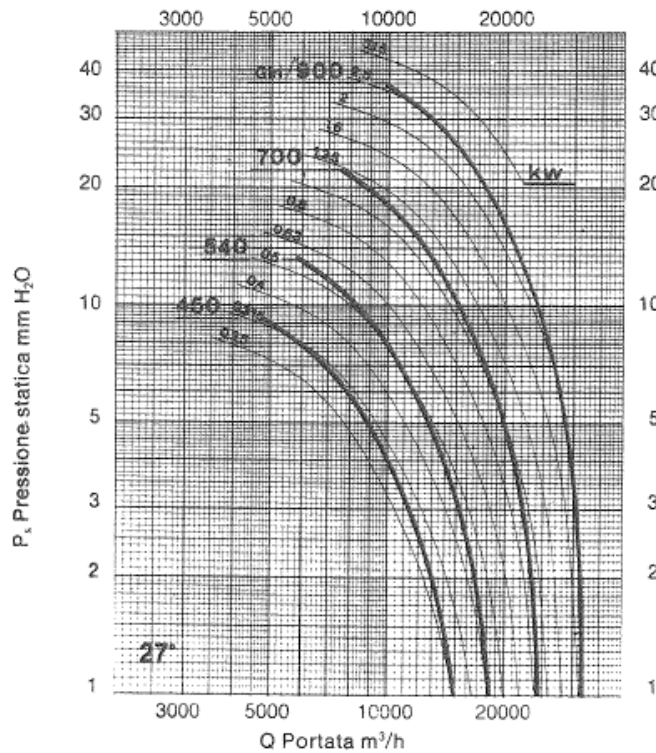
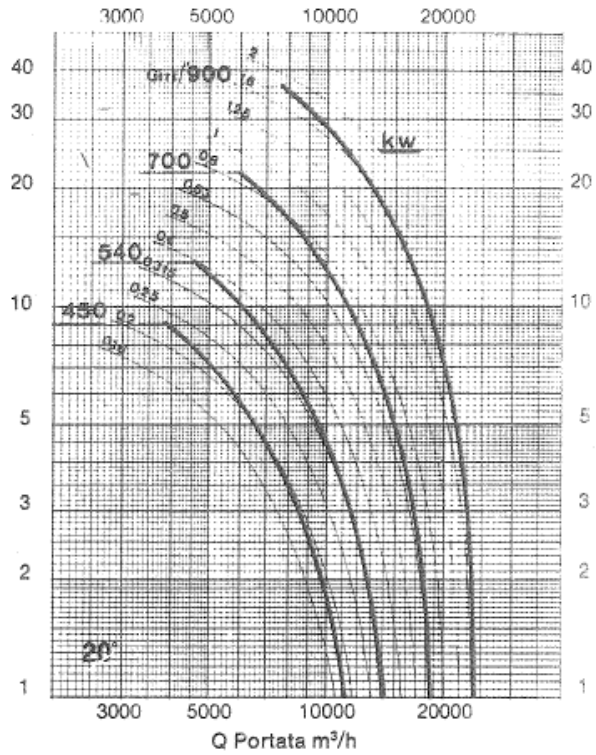
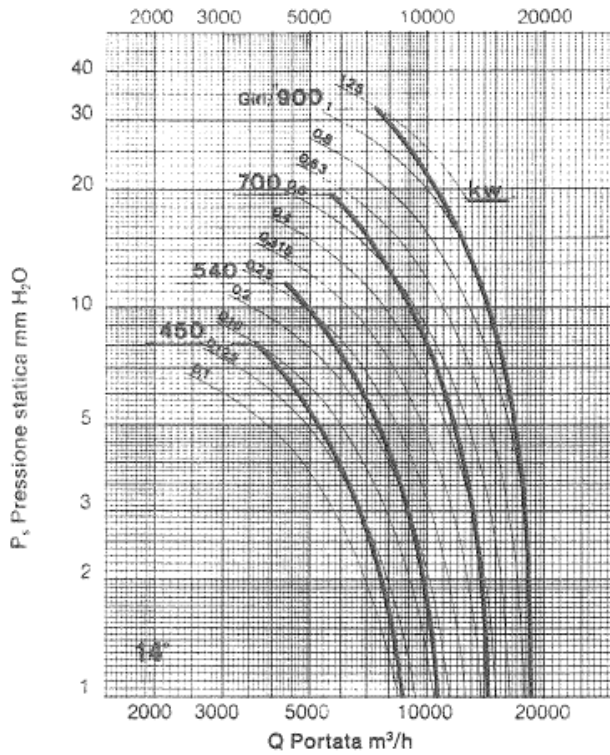

900



ISO 9001
Certificate N° 10-Q-10177-TIC

Ventilmotor S.r.l. a socio unico

Uffici e stabilimento: Via Piaggio, 74 - 20037 Paderno Dugnano (Mi) - **Sede Legale:** Via G. Pogliani, 34 - Paderno Dugnano (Mi)
Tel. +39 02.9101051 / +39 02.99041382 - Fax: +39 02.9103661 - info@ventilmotor.com - www.ventilmotor.com

Cap. Sociale € 10400,00 i.v. - REA 1519030 - N. Registro Imprese MI 53691 - Partita IVA 02632870966

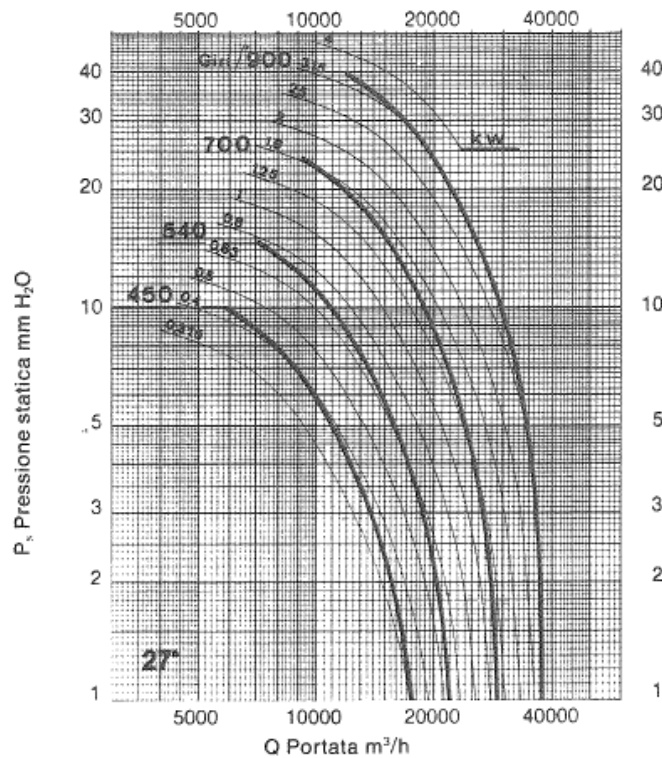
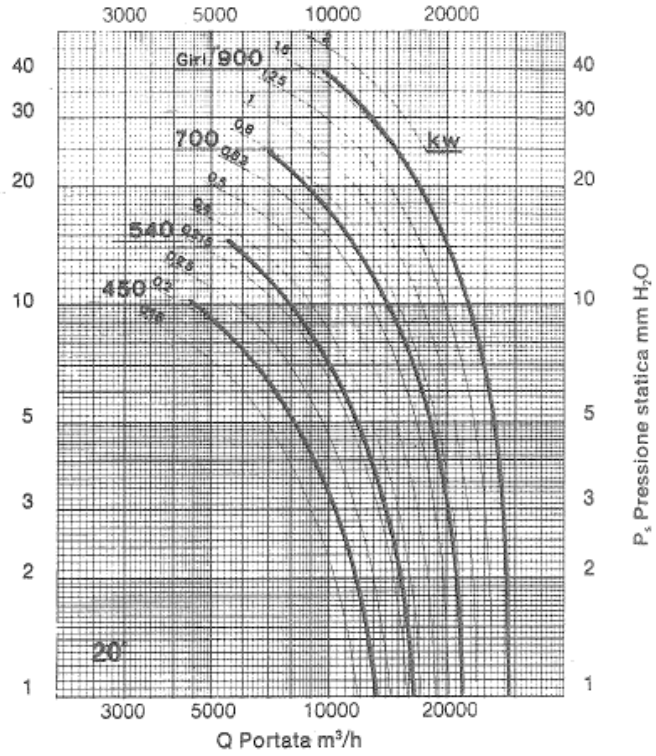
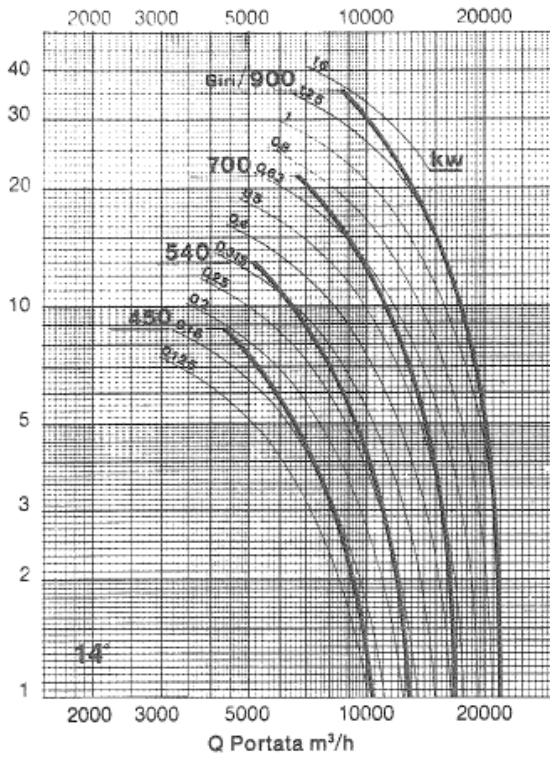

950



ISO 9001
Certificate N° 10-Q-10177-TIC

Ventilmotor S.r.l. a socio unico

Uffici e stabilimento: Via Piaggio, 74 - 20037 Paderno Dugnano (Mi) - **Sede Legale:** Via G. Pogliani, 34 - Paderno Dugnano (Mi)
Tel. +39 02.9101051 / +39 02.99041382 - Fax: +39 02.9103661 - info@ventilmotor.com - www.ventilmotor.com

Cap. Sociale € 10400,00 i.v. - REA 1519030 - N. Registro Imprese MI 53691 - Partita IVA 02632870966

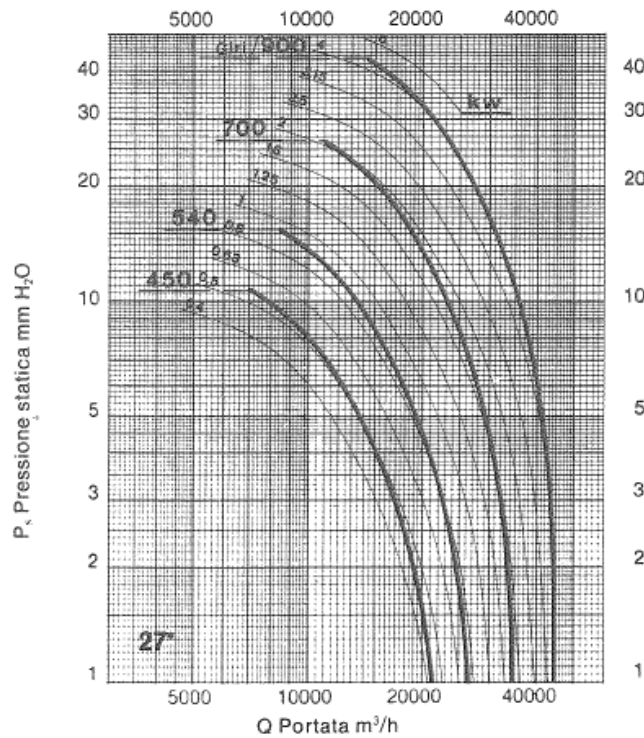
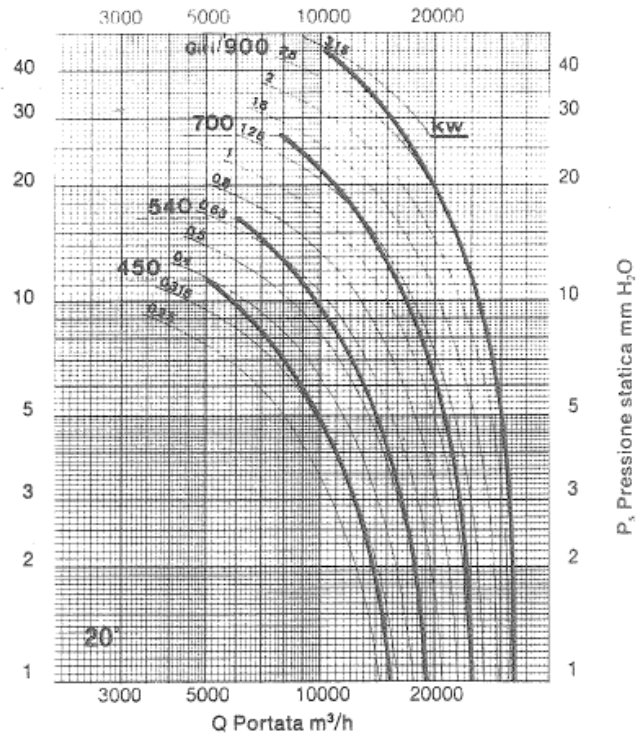
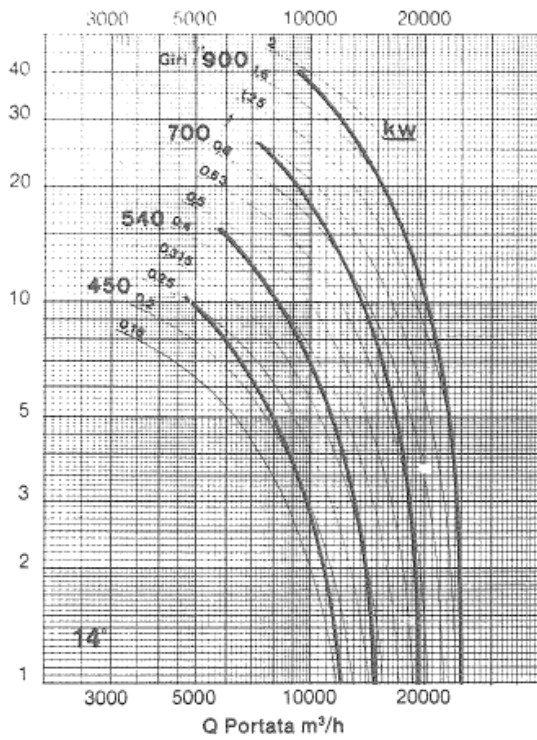

1000



ISO 9001
Certificate N° 10-Q-10177-TIC

Ventilmotor S.r.l. a socio unico

Uffici e stabilimento: Via Piaggio, 74 - 20037 Paderno Dugnano (Mi) - **Sede Legale:** Via G. Pogliani, 34 - Paderno Dugnano (Mi)
Tel. +39 02.9101051 / +39 02.99041382 - Fax: +39 02.9103661 - info@ventilmotor.com - www.ventilmotor.com

Cap. Sociale € 10400,00 i.v. - REA 1519030 - N. Registro Imprese MI 53691 - Partita IVA 02632870966

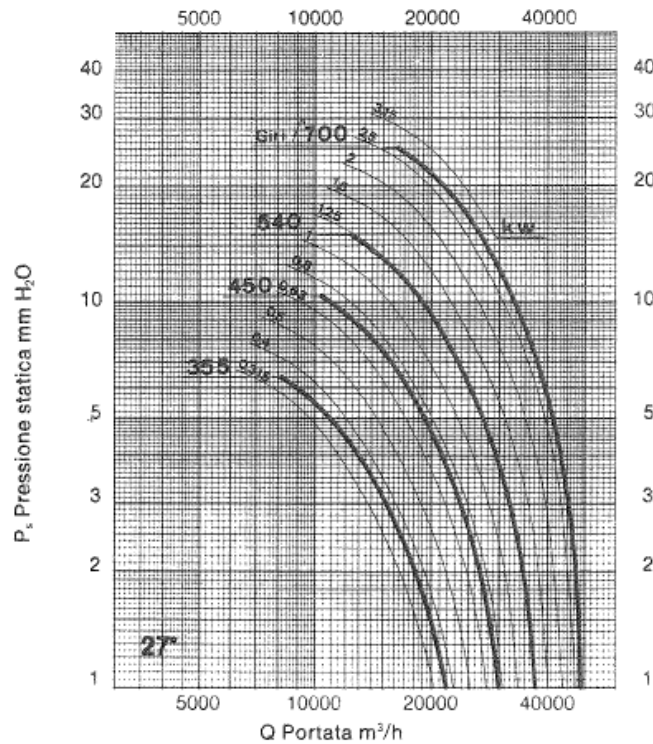
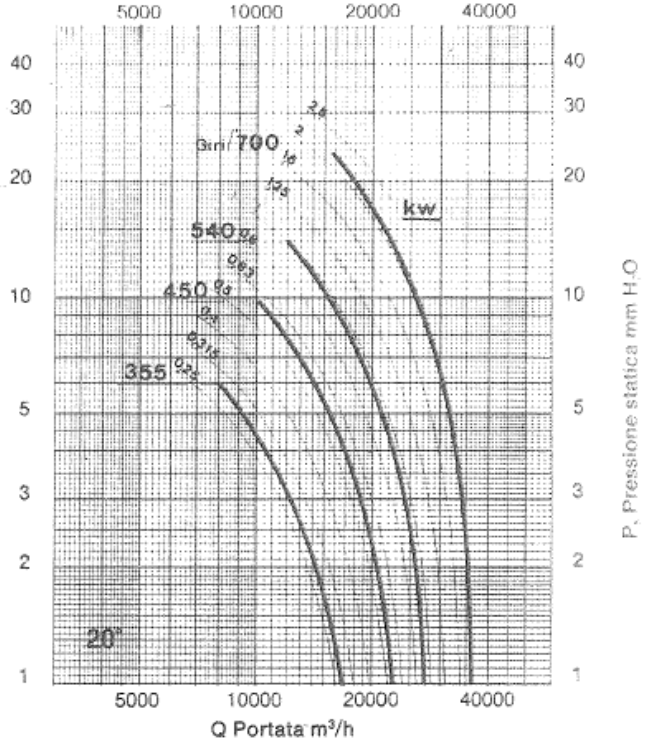
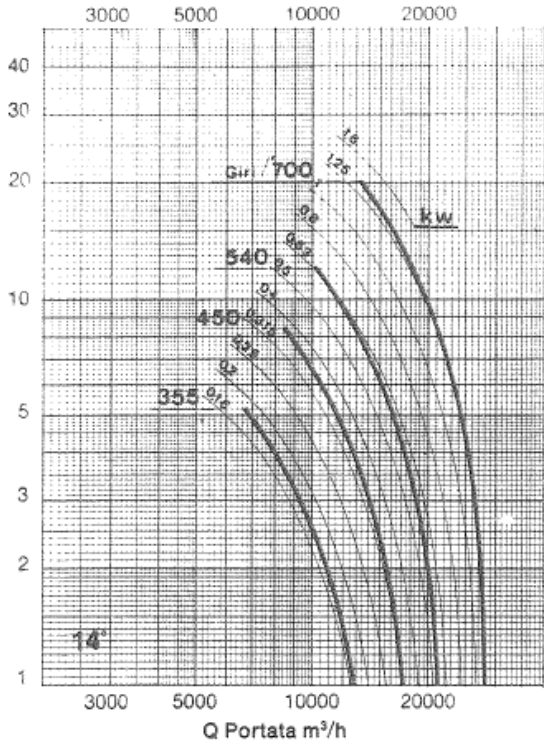

1100



ISO 9001
Certificate N° 10-Q-10177-TIC

Ventilmotor S.r.l. a socio unico

Uffici e stabilimento: Via Piaggio, 74 - 20037 Paderno Dugnano (Mi) - **Sede Legale:** Via G. Pogliani, 34 - Paderno Dugnano (Mi)
Tel. +39 02.9101051 / +39 02.99041382 - Fax: +39 02.9103661 - info@ventilmotor.com - www.ventilmotor.com

Cap. Sociale € 10400,00 i.v. - REA 1519030 - N. Registro Imprese MI 53691 - Partita IVA 02632870966

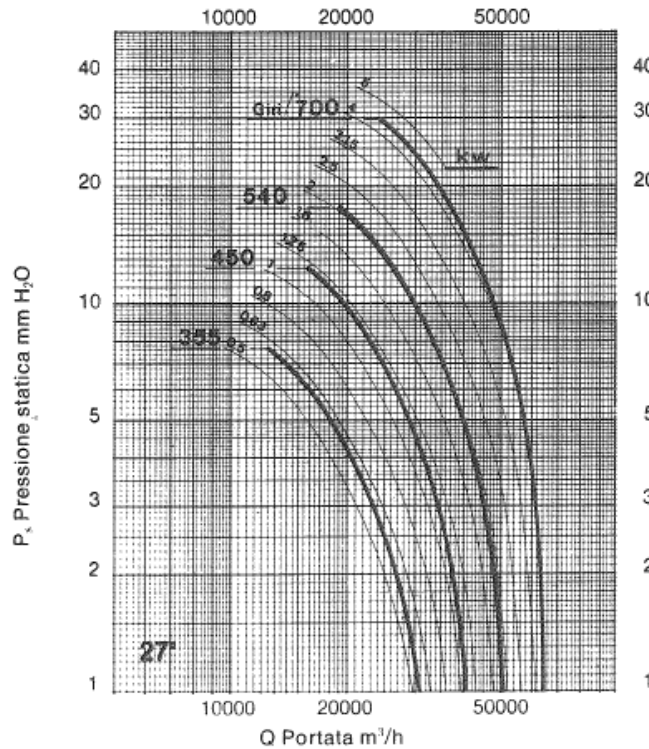
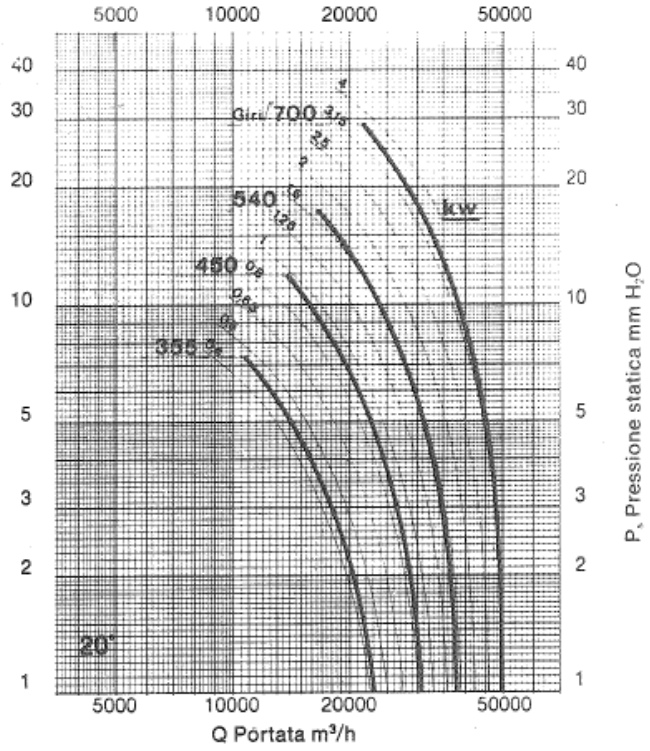
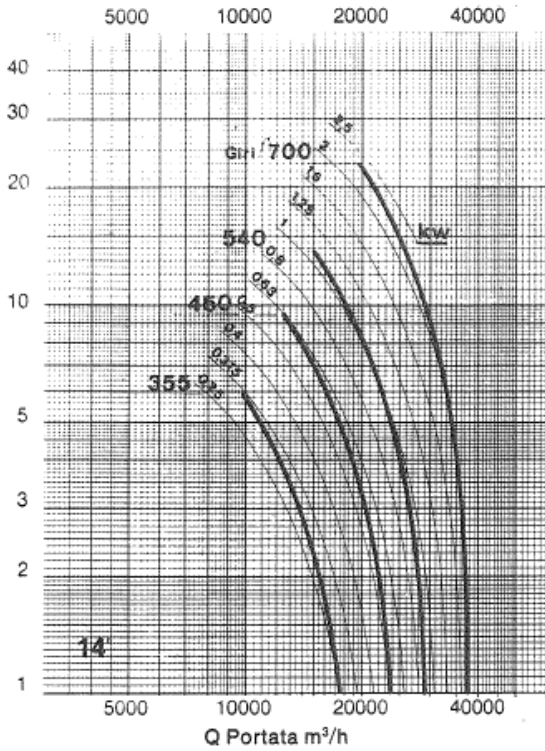

1235



ISO 9001
Certificate N° 10-Q-10177-TIC

Ventilmotor S.r.l. a socio unico

Uffici e stabilimento: Via Piaggio, 74 - 20037 Paderno Dugnano (Mi) - **Sede Legale:** Via G. Pogliani, 34 - Paderno Dugnano (Mi)
Tel. +39 02.9101051 / +39 02.99041382 - Fax: +39 02.9103661 - info@ventilmotor.com - www.ventilmotor.com

Cap. Sociale € 10400,00 i.v. - REA 1519030 - N. Registro Imprese MI 53691 - Partita IVA 02632870966

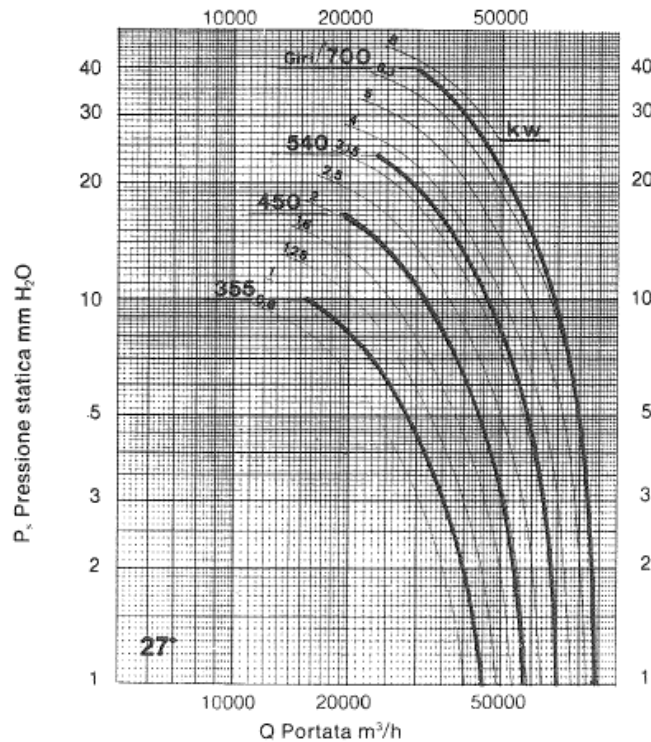
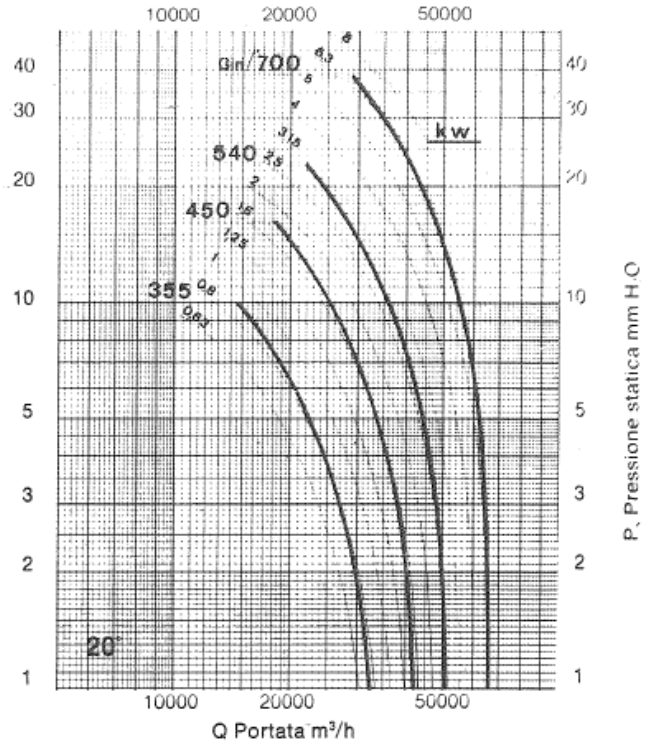
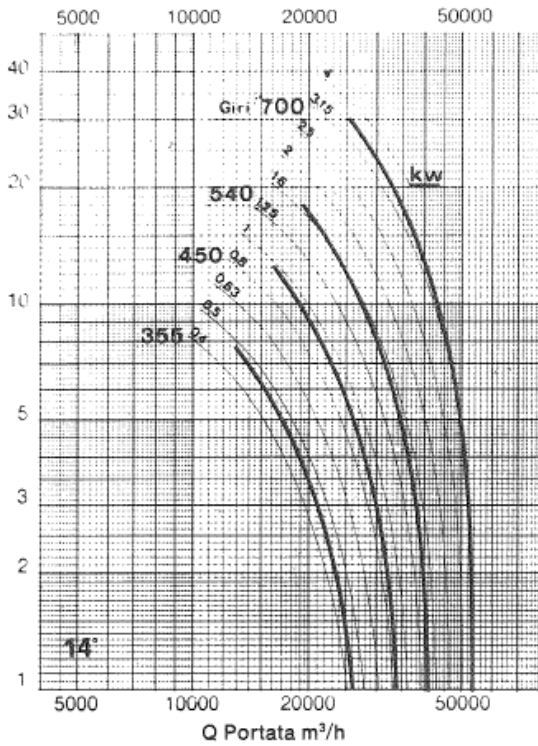

1370



ISO 9001
Certificate N° 10-Q-10177-TIC

Ventilmotor S.r.l. a socio unico

Uffici e stabilimento: Via Piaggio, 74 - 20037 Paderno Dugnano (Mi) - **Sede Legale:** Via G. Pogliani, 34 - Paderno Dugnano (Mi)
Tel. +39 02.9101051 / +39 02.99041382 - Fax: +39 02.9103661 - info@ventilmotor.com - www.ventilmotor.com

Cap. Sociale € 10400,00 i.v. - REA 1519030 - N. Registro Imprese MI 53691 - Partita IVA 02632870966