



***Ventilmotor*** s.r.l.

**VENTILATORI CIVILI - INDUSTRIALI**

**VENTILATORI CENTRIFUGHI  
SERIE "QR"**

# { **SERIE QR** }



I ventilatori centrifughi a semplice aspirazione SERIE QR sono adatti a convogliare aria pulita o leggermente polverosa con temperatura da 15°C a 40°C. Questi ventilatori trovano la loro principale applicazione negli impianti civili e industriali di ventilazione, depurazione, riscaldamento e condizionamento.

MODELLO	A	B	C	D	E	F	G	H	I	J	K	L	M	N	O	P	Q
QR 280	500	570	320	250	210	290	188	228	268	10	305	335	50	273	138	3	2
QR 315	567	622	350	272	250	317	205	245	285	10	335	365	50	303	154	3	2
QR 345	620	675	380	295	275	345	223	263	303	10	365	395	50	333	170	3	2
QR 380	675	735	415	320	300	375	248	288	328	10	400	430	50	368	188	3	2
QR 420	730	805	455	350	320	410	271	311	351	10	445	475	50	410	208	3	2
QR 460	800	875	495	380	350	450	297	337	377	12	485	515	50	450	229	4	3
QR 500	875	960	545	415	380	495	324	374	424	12	540	585	80	498	253	4	3
QR 560	955	1065	605	460	410	545	364	414	464	12	590	630	80	546	276	4	3
QR 625	1045	1170	665	505	450	595	400	450	500	12	650	690	80	606	308	5	3
QR 685	1140	1280	725	555	485	655	438	488	538	14	715	755	80	670	338	5	4

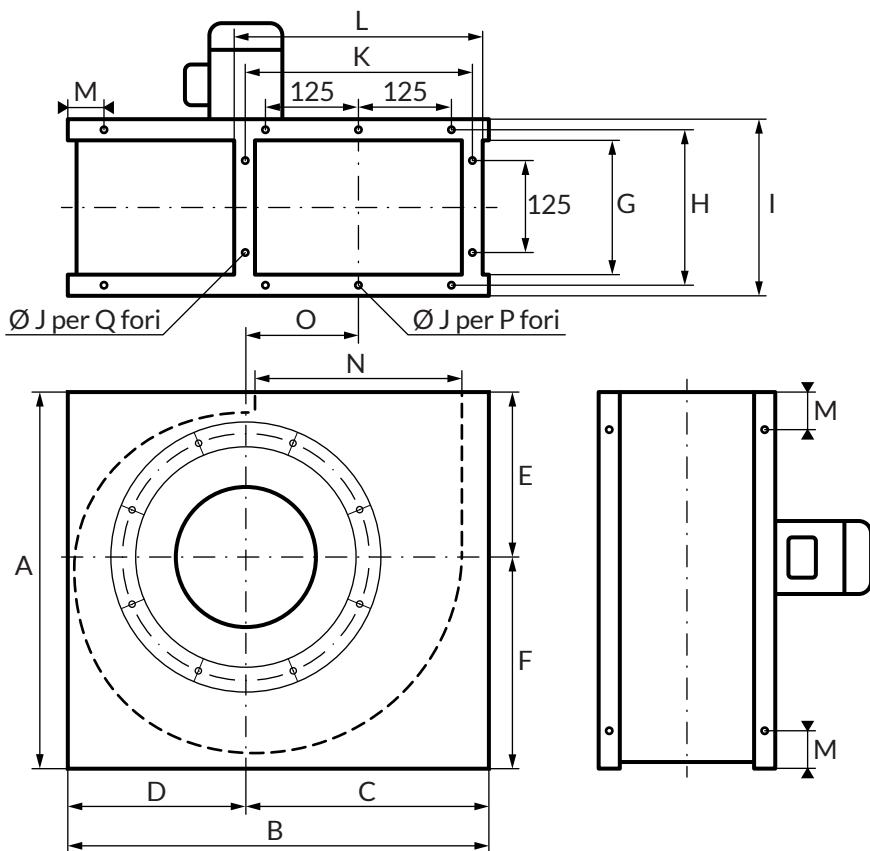

PT mmH<sup>2</sup>O

### 2800 RPM

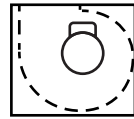
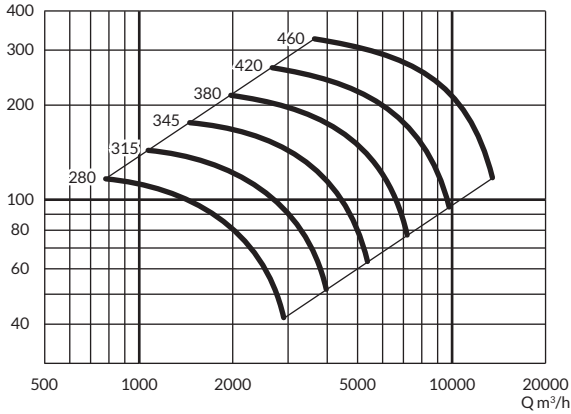

RD 0

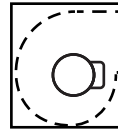

RD 90

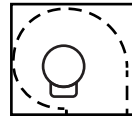

RD 180

PT mmH<sup>2</sup>O

### 1400 RPM

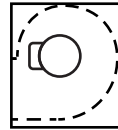
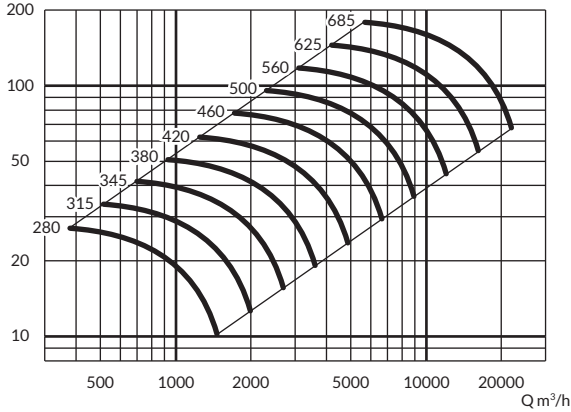

RD 270

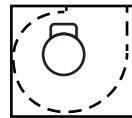

LG 0

PT mmH<sup>2</sup>O

### 900 RPM

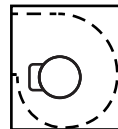
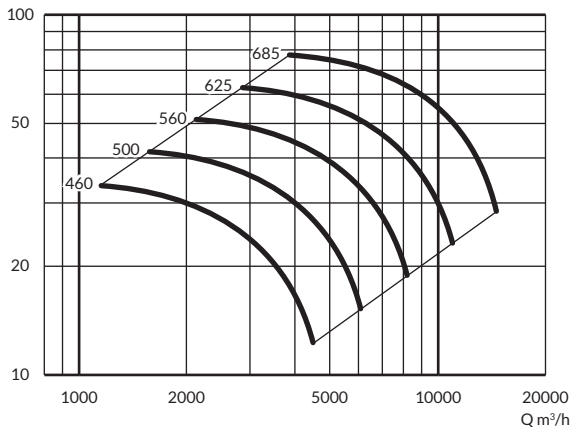

LG 90

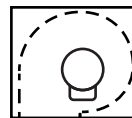

LG 180

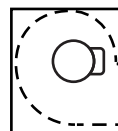

LG 270

**Ventilmotor s.r.l a socio unico ©2016**

Uffici e Stabilimento: Via Piaggio, 74 - 20037 - Paderno Dugnano (MI) Sede Legale: Via G. Pogliani, 34 - Paderno Dugnano (MI)

Tel: +39 02.9101051 / +39 02.99041382 Fax: +39 02.9103661 Web: info@ventilmotor.com - www.ventilmotor.com

Capitale Sociale € 10400.00 i.v. - REA 1519030 - N° Registro Imprese MI 53691 - P. Iva 02632870966 - ITALY



Certificate n° 10-Q-10177-TIC