

## **SERIE EVI D-T-S**



### **DESTINAZIONE D'USO**

- Adatto a convogliare aria umida o polverosa e gas nocivi
- Ventilatore intubato
- Numero di pale: 6
- Disponibile in 3 versioni:

**D:** direttamente accoppiato, temperatura fluido massima 40°C (a richiesta 60°C)

**T:** a trasmissione, con pulegge, cinghie trapezoidali, temperatura fluido massima 100°C, a richiesta 150°C

**S:** motore sporgente, anello basso

### **DATI TECNICI**

- Motore 1400 Giri / 1', da 184 a 2944 W: Portata da 750 a 45000 m<sup>3</sup>/h con pressione fino a 100 mm H<sub>2</sub>O, secondo grandezze e potenze
- Motore 900 Giri / 1', da 368 a 11040 W: Portata da 400 a 30000 m<sup>3</sup>/h con pressione fino a 50 mm H<sub>2</sub>O, secondo grandezze e potenze

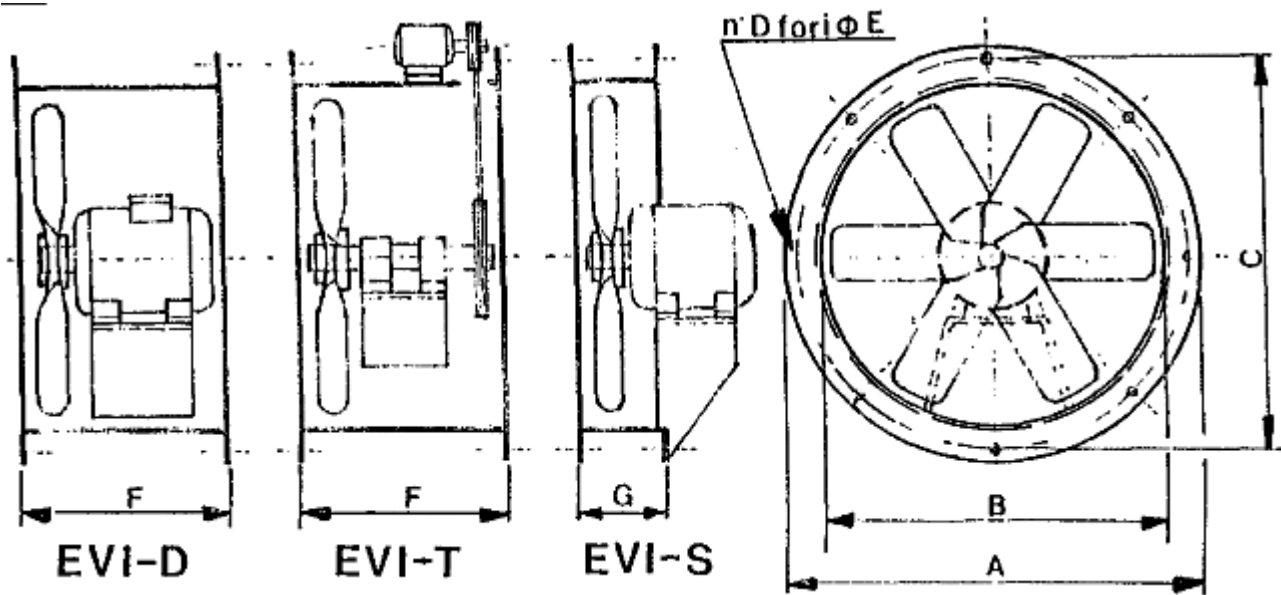

EVI-D-T-S	40	50	60	70	80	90	100
A	490	590	690	790	890	990	1090
B	430	530	630	730	830	930	1030
C	460	560	660	760	860	960	1060
D	8	8	8	8	8	8	8
E	8,5	8,5	8,5	8,5	8,5	8,5	8,5
F	370	370	540	580	640	690	690
G	130	170	170	200	200	220	220

EVI-D-T-S	40	50	60	70	80	90	100	
<b>Giri / 1'</b> <b>900</b>	Hp	0,25	0,25	0,5	0,75	2	3	4
	W	184	184	368	552	1472	2208	2944
Portata Min./ Max. (m <sup>3</sup> /h)	400/1300	900/3000	2000/6500	3100/8500	11000/15000	9000/19000	7500/30000	
Pressione max. (mm H <sub>2</sub> O)	20	30	50	50	60	80	100	
<b>Giri / 1'</b> <b>1400</b>	Hp	0,5	1	2	3	7,5	10	15
	W	368	736	1472	2208	5520	7360	11040
Portata Min./ Max. (m <sup>3</sup> /h)	750 / 2300	2300 / 5500	3000 / 9000	5000 / 15000	9000 / 20000	11000 / 28000	15000 / 45000	
Pressione max. (mm H <sub>2</sub> O)	10	15	20	20	15	30	50	

# EVI-D-T-S 40

mm  
H<sub>2</sub>O

**1400 giri / 1'**

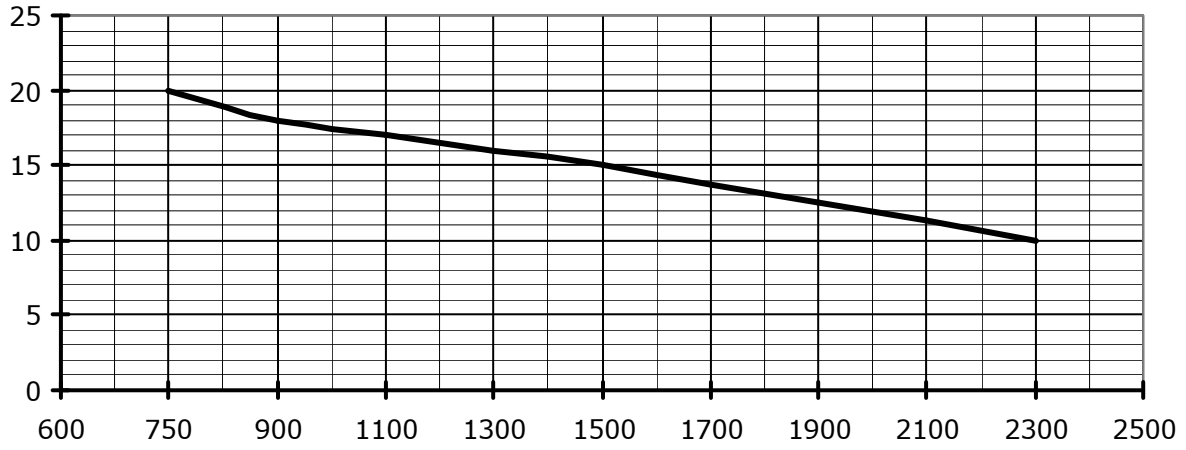

m³/h

mm  
H<sub>2</sub>O

**900 giri / 1'**

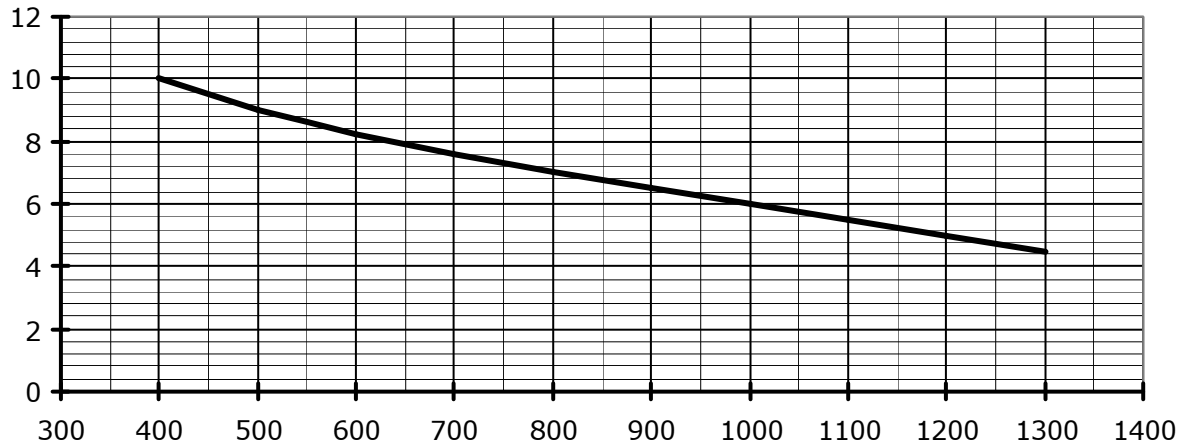

m³/h

# EVI-D-T-S 50

mm  
H<sub>2</sub>O

**1400 giri / 1'**

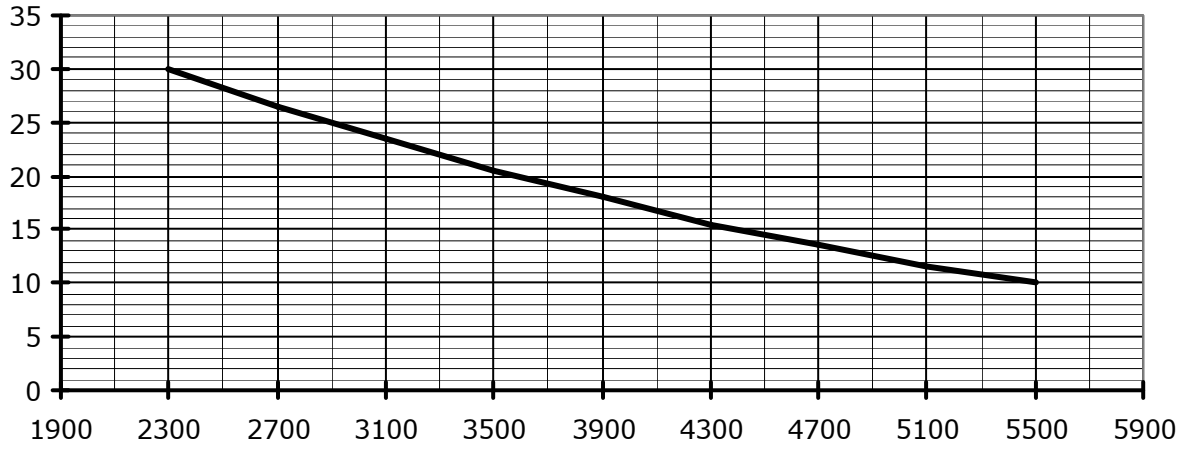

m³/h

mm  
H<sub>2</sub>O

**900 giri / 1'**

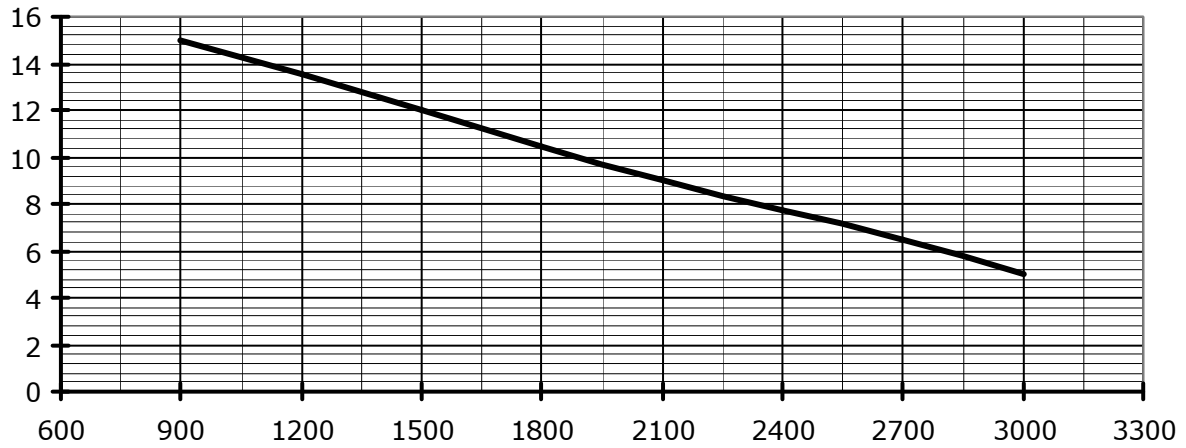

m³/h

# EVI-D-T-S 60

mm  
H<sub>2</sub>O

**1400 giri / 1'**

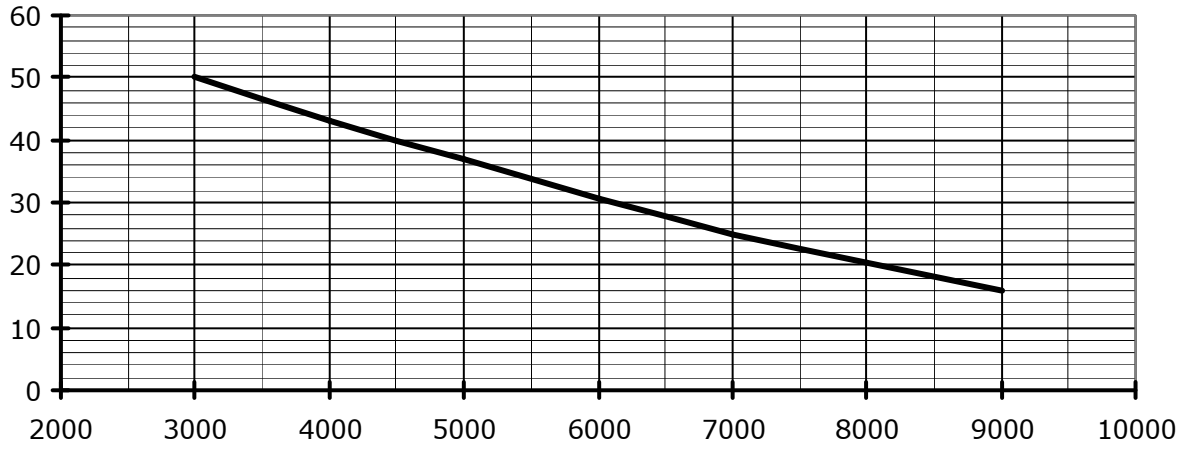

m³/h

mm  
H<sub>2</sub>O

**900 giri / 1'**

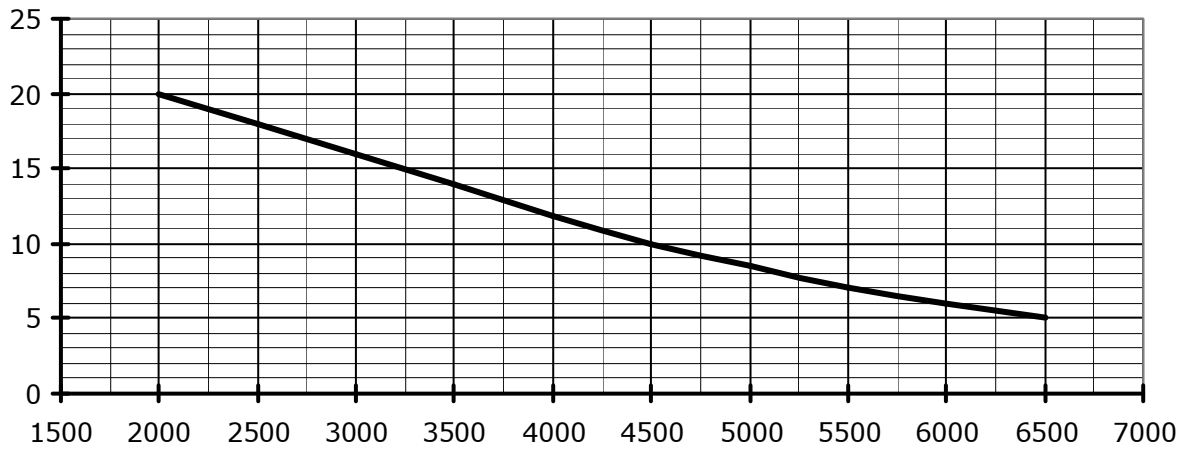

m³/h

# EVI-D-T-S 70

mm  
H<sub>2</sub>O

**1400 giri / 1'**

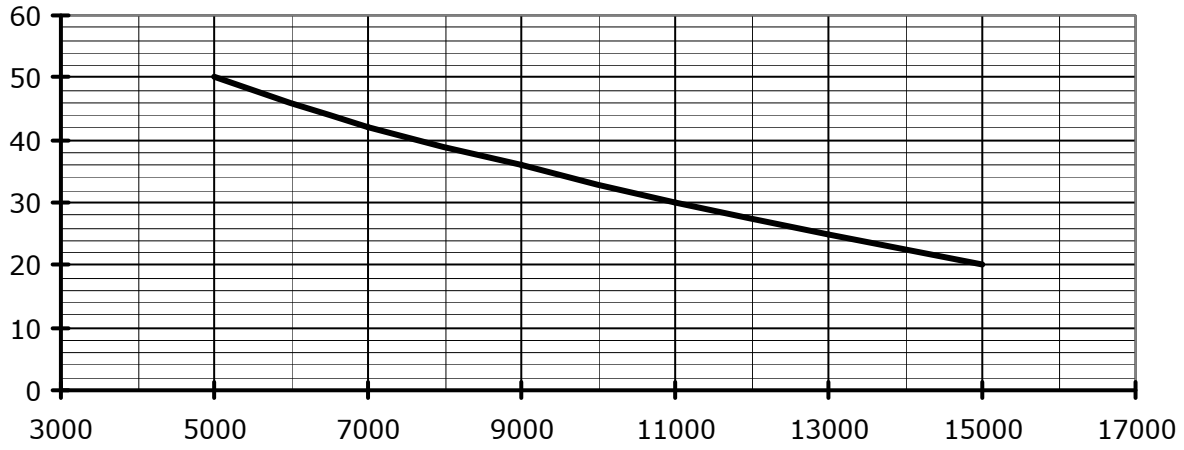

m<sup>3</sup>/h

mm  
H<sub>2</sub>O

**900 giri / 1'**

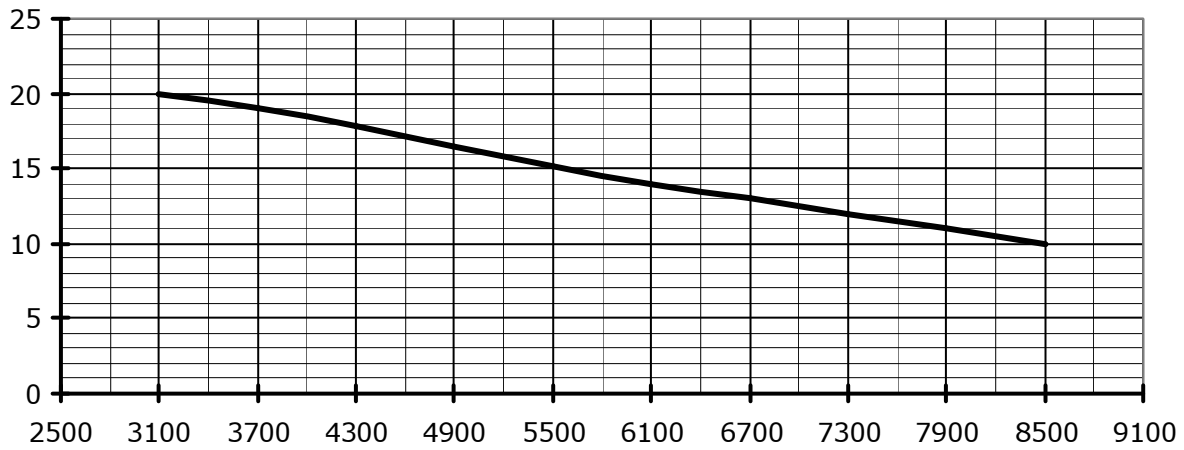

m<sup>3</sup>/h

# EVI-D-T-S 80

mm  
H<sub>2</sub>O

**1400 giri / 1'**

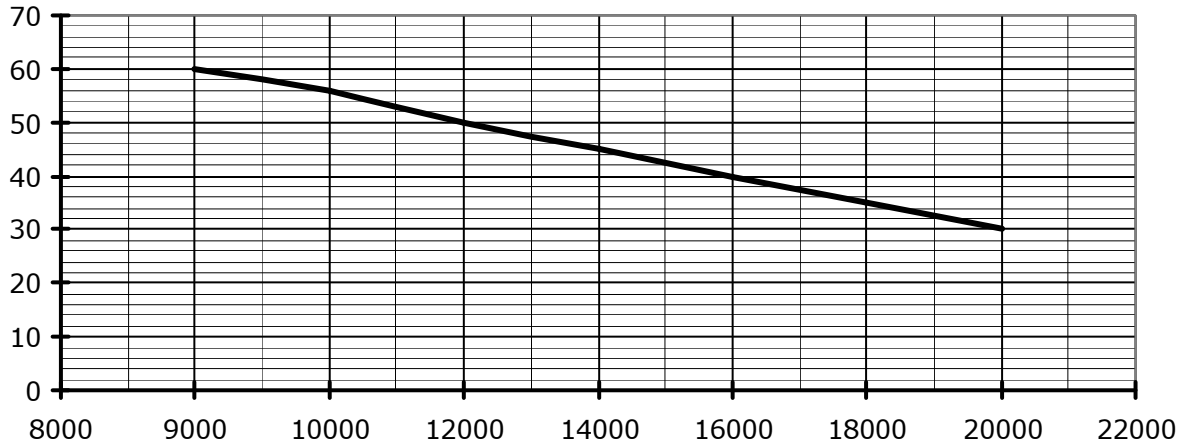

m³/h

mm  
H<sub>2</sub>O

**900 giri / 1'**

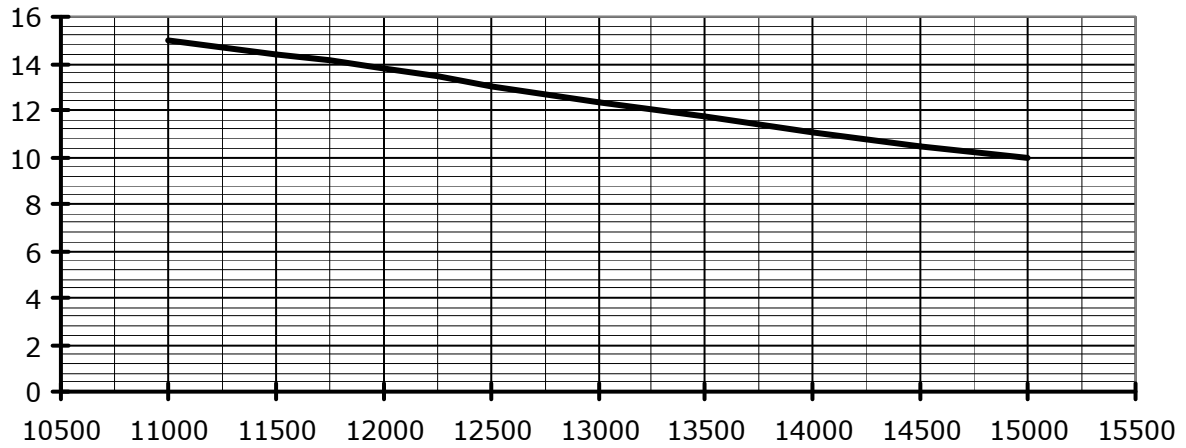

m³/h

# EVI-D-T-S 90

mm  
H<sub>2</sub>O

**1400 giri / 1'**

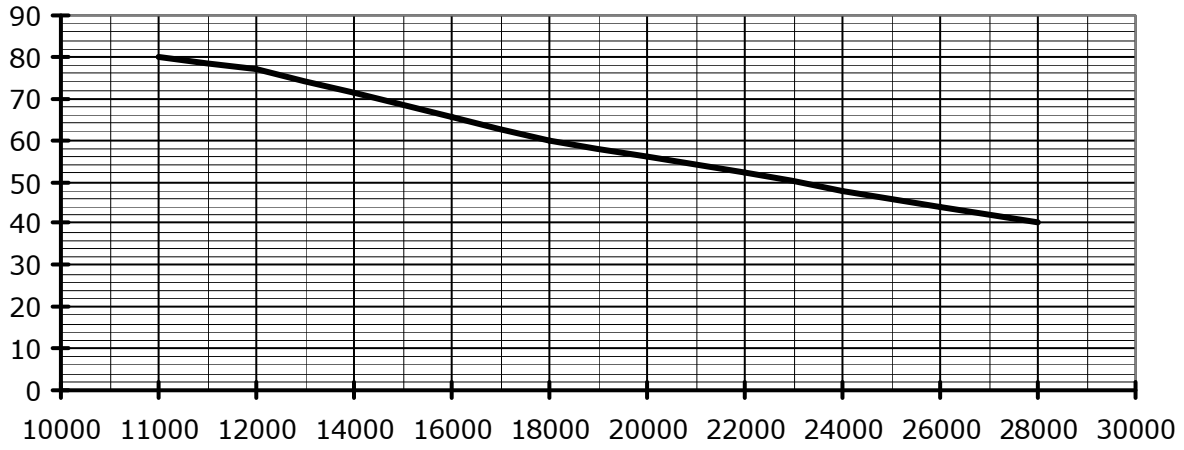

m³/h

mm  
H<sub>2</sub>O

**900 giri / 1'**

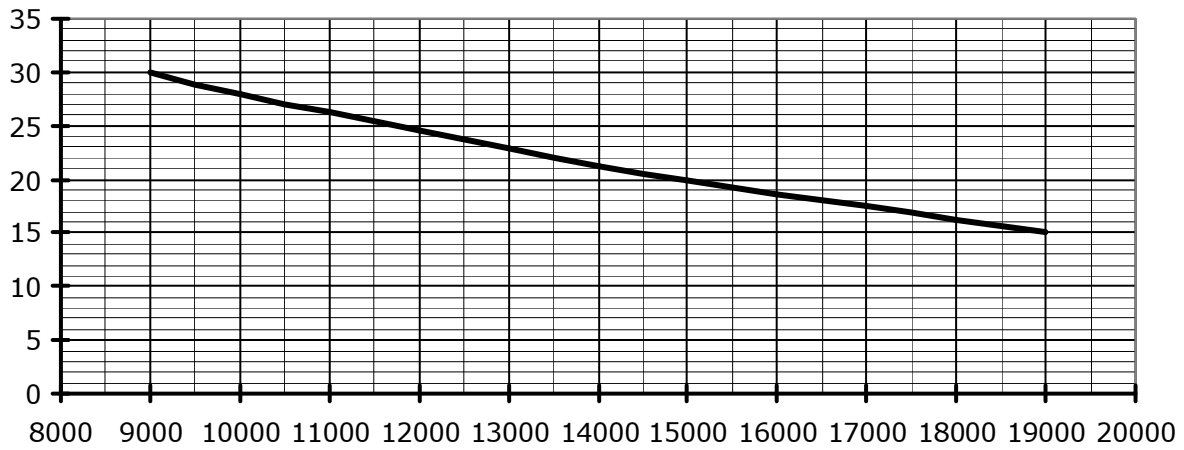

m³/h



# EVI-D-T-S 100

mm  
H<sub>2</sub>O

**1400 giri / 1'**

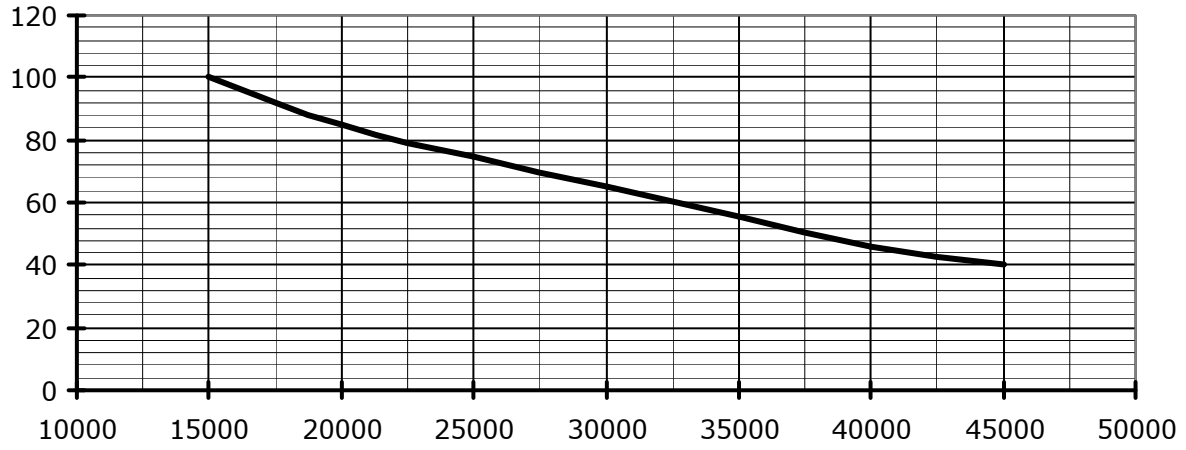

m³/h

mm  
H<sub>2</sub>O

**900 giri / 1'**

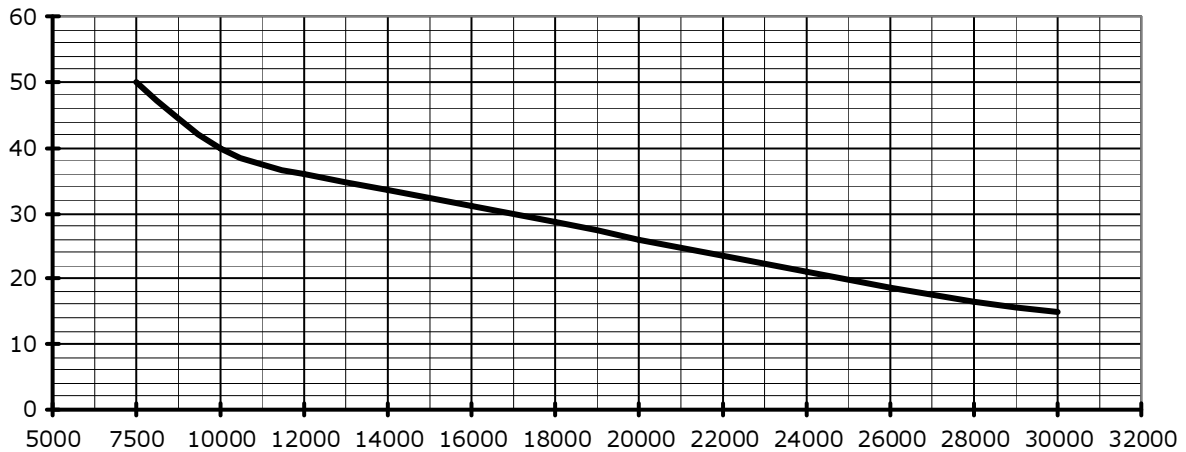

m³/h