



Ventilmotor s.r.l.

VENTILATORI CIVILI - INDUSTRIALI

**VENTILATORI CENTRIFUGHI
SERIE "EV-D"**

(**SERIE EV-D**)

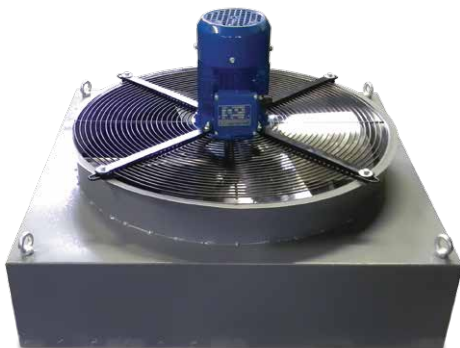

Il destratificatore EV-D è pensato per la circolazione dell'aria calda riportando il calore verso il basso e riducendo il consumo di energia per il riscaldamento fino al 40%. Il destratificatore EV-D può essere utilizzato anche nei mesi estivi per avere un effetto ventilante e rinfrescante.

MODELLO	A	B	C	Pot. Inst. (Kw)	RPM	Portata (m ³ /h)
EV-D 460	600	600	150	0.12	900	2900
EV-D 610	750	750	150	0.18	900	7000

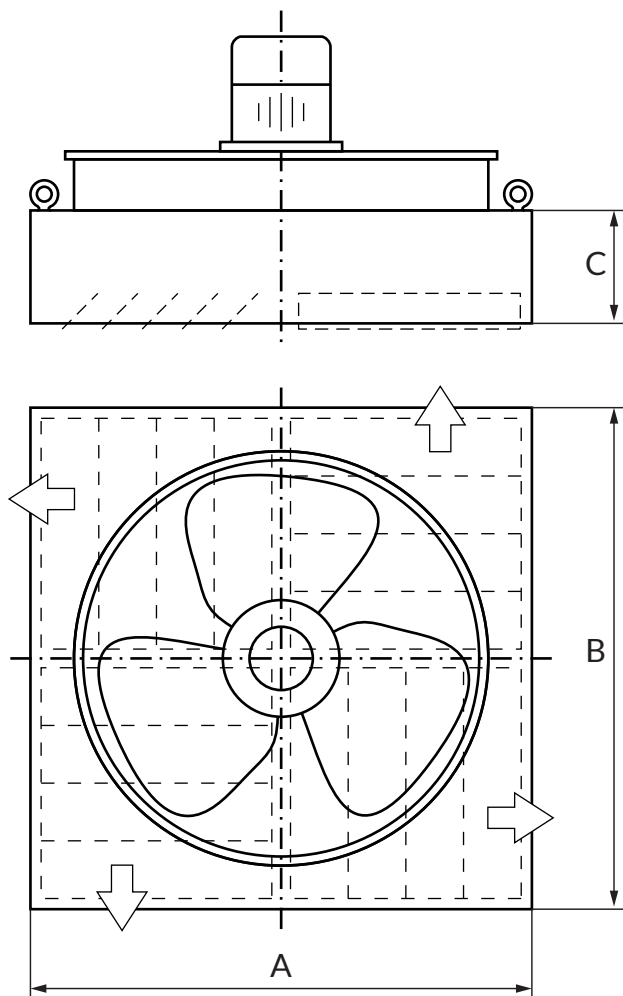

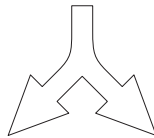
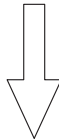
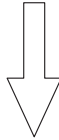
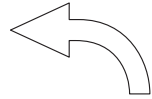
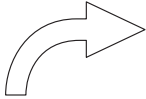
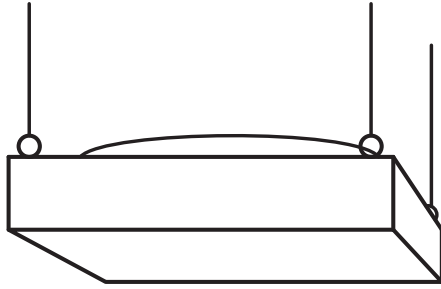

Ventilmotor s.r.l a socio unico ©2016

Uffici e Stabilimento: Via Piaggio, 74 - 20037 - Paderno Dugnano (MI) Sede Legale: Via G. Pogliani, 34 - Paderno Dugnano (MI)
Tel: +39 02.9101051 / +39 02.99041382 Fax: +39 02.9103661 Web: info@ventilmotor.com - www.ventilmotor.com
Capitale Sociale € 10400.00 i.v. - REA 1519030 - N° Registro Imprese MI 53691 - P. Iva 02632870966 - ITALY



Certificate n° 10-Q-10177-TIC