

## **SERIE EV-6** VENTILATORE ELICOIDALE



### **DESTINAZIONE D'USO**

- Adatto a ricambiare l'aria nell'ambiente e per altri usi industriali specifici
- Dotato di boccaglio convogliatore, supporto motore, rete di protezione
- Numero di pale: 6

### **DATI TECNICI**

- Motore 1400 Giri / 1', da 130 a 1104 W: Portata da 350 a 16.000 m<sup>3</sup>/h con pressione fino a 40 mm H<sub>2</sub>O, secondo grandezze e potenze
- Motore 900 Giri / 1', da 184 a 368 W: Portata da 600 a 11.500 m<sup>3</sup>/h con pressione fino a 20 mm H<sub>2</sub>O, secondo grandezze e potenze



ISO 9001  
Certificate N° 10-Q-10177-TIC

**Ventilmotor S.r.l. a socio unico**

**Uffici e stabilimento:** Via Piaggio, 74 - 20037 Paderno Dugnano (Mi) - **Sede Legale:** Via G. Pogliani, 34 - Paderno Dugnano (Mi)  
Tel. +39 02.9101051 / +39 02.99041382 - Fax: +39 02.9103661 - [info@ventilmotor.com](mailto:info@ventilmotor.com) - [www.ventilmotor.com](http://www.ventilmotor.com)  
Cap. Sociale € 10400,00 i.v. - REA 1519030 - N. Registro Imprese MI 53691 - Partita IVA 02632870966

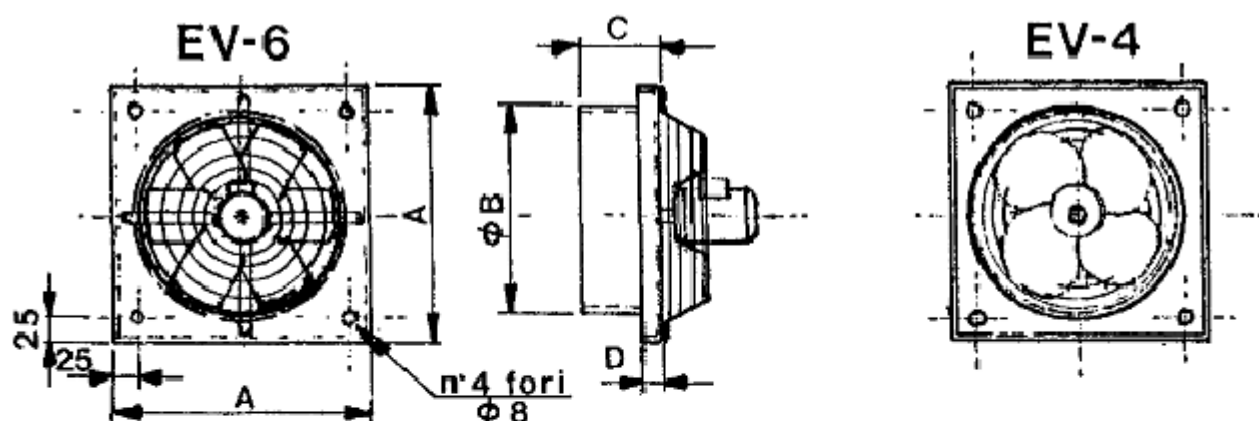

MODELLO	EV-6 260	EV-6 310	EV-6 360	EV-6 410	EV-6 460	EV-6 510	EV-6 560	EV-6 610
A	350	400	450	500	550	600	680	715
B	300	350	400	450	500	550	630	680
C	65	65	65	65	65	65	65	65
D	15	15	15	15	15	15	15	15

MODELLO	EV-6 260	EV-6 310	EV-6 360	EV-6 410	EV-6 460	EV-6 510	EV-6 560	EV-6 610	
Giri / 1' 1400	Hp	0,18	0,18	0,25	0,33	0,5	0,75	1	1,5
	W	130	130	184	243	368	552	736	1104
Portata Min./Max. (m³/h)	350 / 1300	1300 / 2300	1000 / 3000	1000 / 4500	2400 / 5400	3000 / 9000	5000 / 12000	7000 / 15000	
Pressione max. (mm H <sub>2</sub> O)	10	10	20	20	20	30	30	40	
Giri / 1' 900	Hp	-	-	0,25	0,25	0,25	0,25	0,33	0,5
	W	-	-	184	184	184	184	243	368
Portata Min./Max. (m³/h)	-	-	600 / 1800	1000 / 2600	1100 / 3100	2600 / 5000	2000 / 8000	4000 / 10000	
Pressione max. (mm H <sub>2</sub> O)	-	-	10	10	10	10	20	20	

mm  
H<sub>2</sub>O

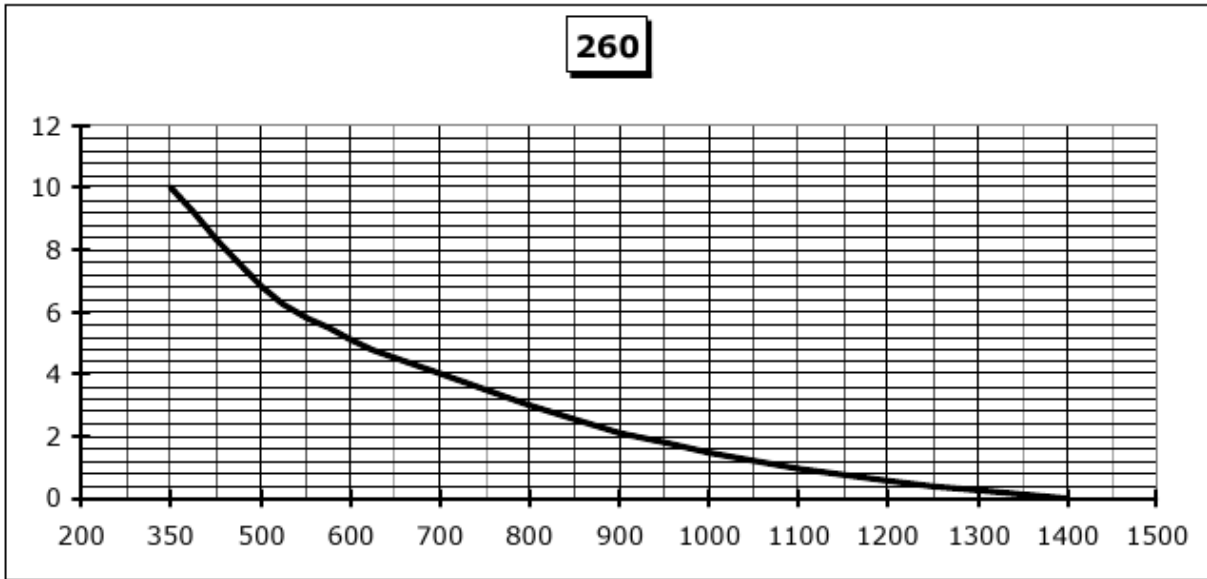

m<sup>3</sup>/h

mm  
H<sub>2</sub>O

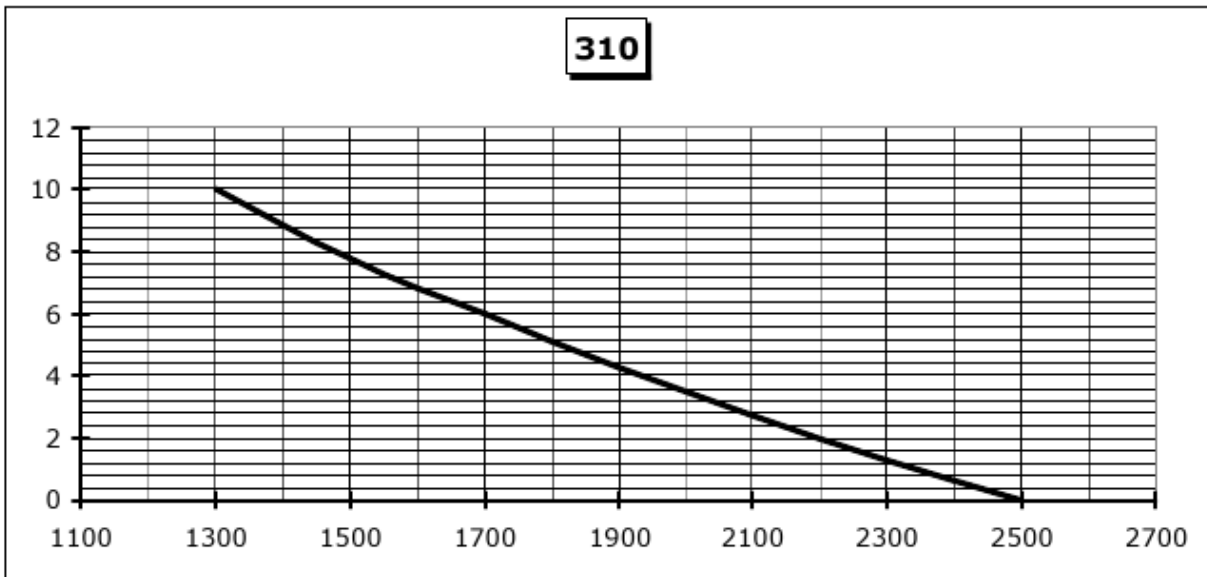

m<sup>3</sup>/h



ISO 9001  
Certificate N° 10-Q-10177-TIC

**Ventilmotor S.r.l. a socio unico**

**Uffici e stabilimento:** Via Piaggio, 74 - 20037 Paderno Dugnano (Mi) - **Sede Legale:** Via G. Pogliani, 34 - Paderno Dugnano (Mi)  
Tel. +39 02.9101051 / +39 02.99041382 - Fax: +39 02.9103661 - [info@ventilmotor.com](mailto:info@ventilmotor.com) - [www.ventilmotor.com](http://www.ventilmotor.com)

Cap. Sociale € 10400,00 i.v. - REA 1519030 - N. Registro Imprese MI 53691 - Partita IVA 02632870966

**360**

mm  
H<sub>2</sub>O

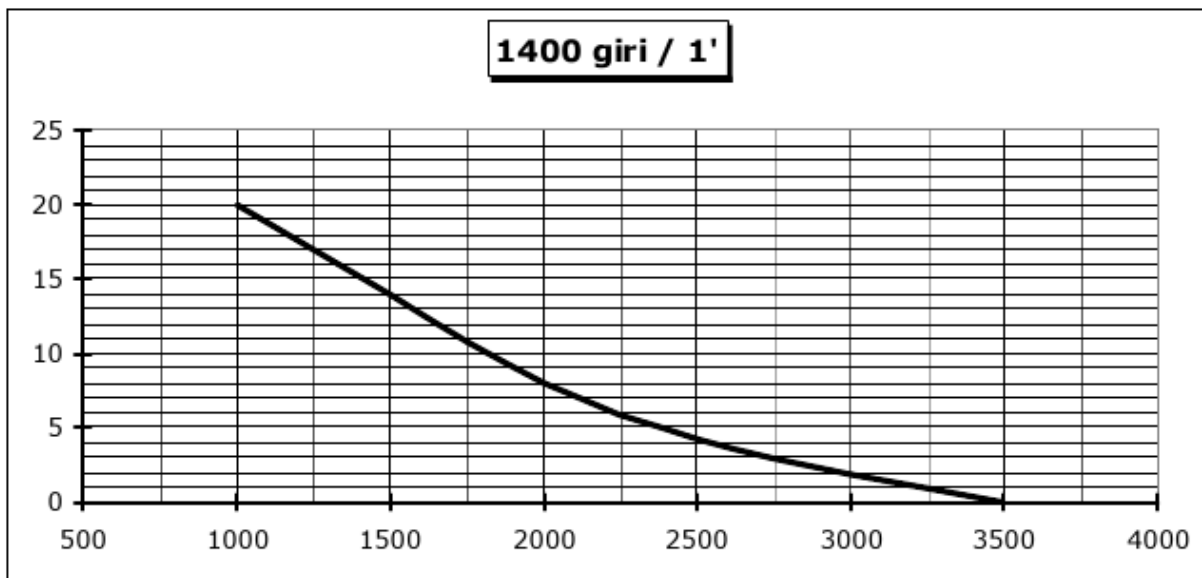

m<sup>3</sup>/h

mm  
H<sub>2</sub>O

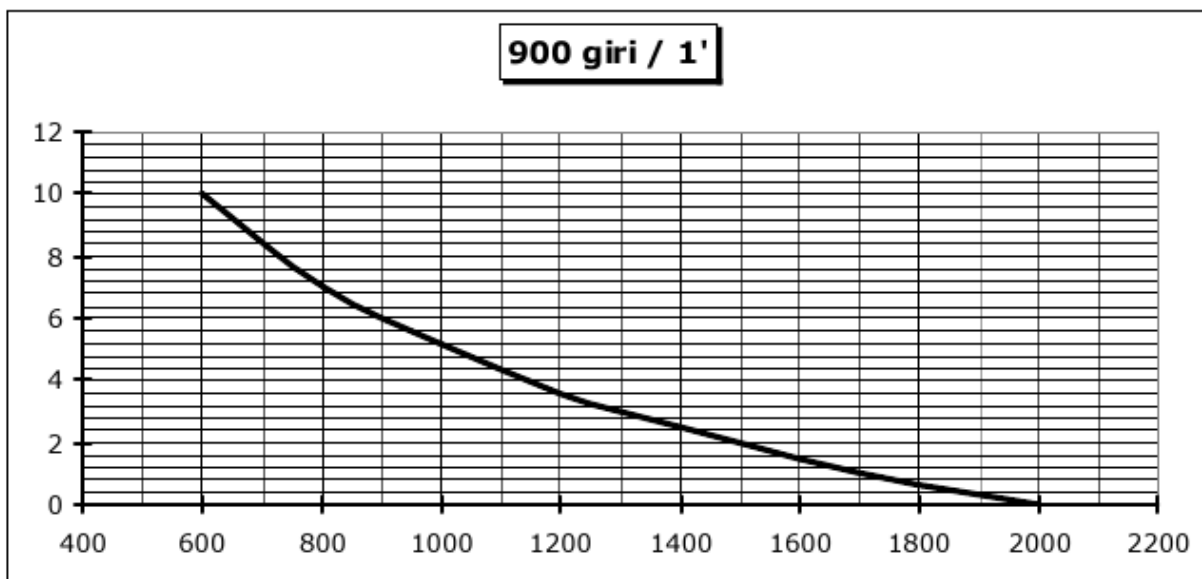

m<sup>3</sup>/h



ISO 9001  
Certificate N° 10-Q-10177-TIC

**Ventilmotor S.r.l. a socio unico**

**Uffici e stabilimento:** Via Piaggio, 74 - 20037 Paderno Dugnano (Mi) - **Sede Legale:** Via G. Pogliani, 34 - Paderno Dugnano (Mi)  
Tel. +39 02.9101051 / +39 02.99041382 - Fax: +39 02.9103661 - [info@ventilmotor.com](mailto:info@ventilmotor.com) - [www.ventilmotor.com](http://www.ventilmotor.com)

Cap. Sociale € 10400,00 i.v. - REA 1519030 - N. Registro Imprese MI 53691 - Partita IVA 02632870966

**410**

mm  
H<sub>2</sub>O

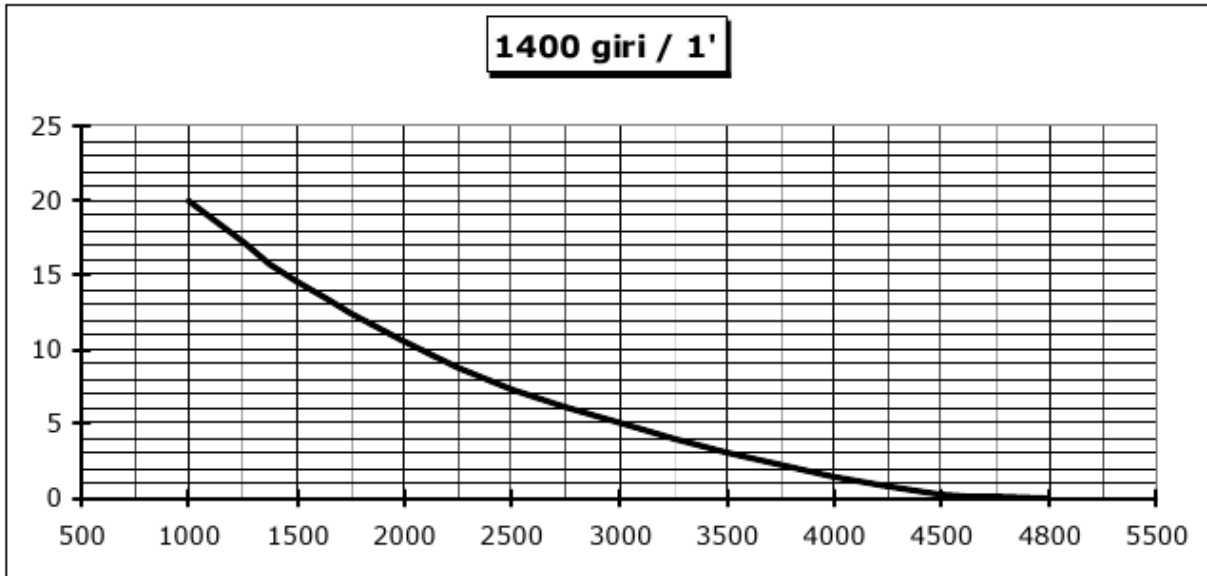

m<sup>3</sup>/h

mm  
H<sub>2</sub>O

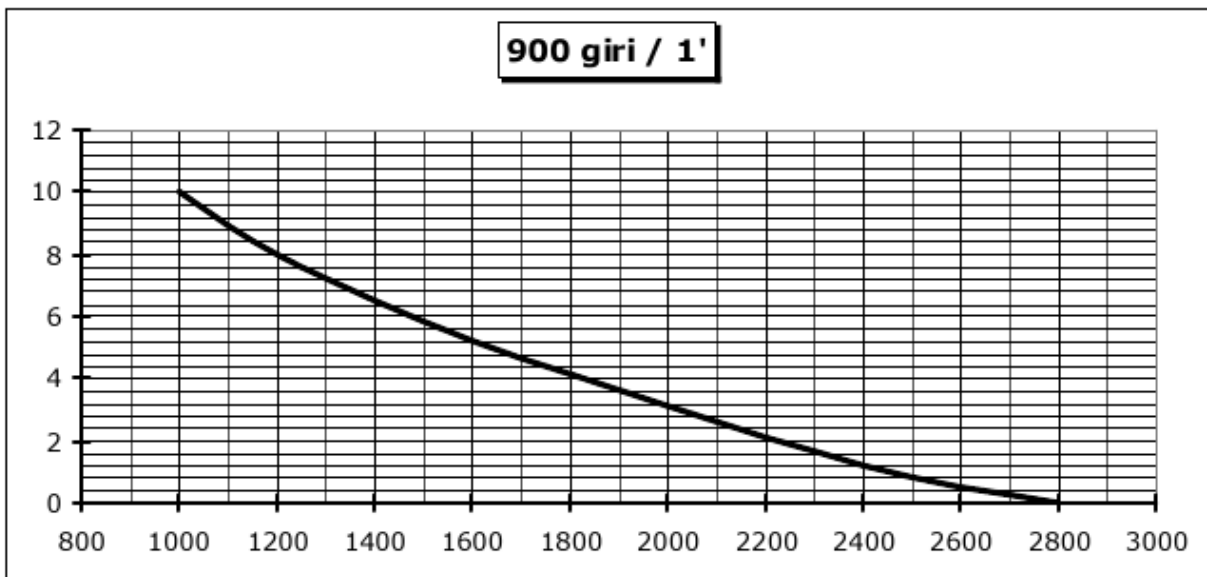

m<sup>3</sup>/h



ISO 9001  
Certificate N° 10-Q-10177-TIC

**Ventilmotor S.r.l. a socio unico**

**Uffici e stabilimento:** Via Piaggio, 74 - 20037 Paderno Dugnano (Mi) - **Sede Legale:** Via G. Pogliani, 34 - Paderno Dugnano (Mi)  
Tel. +39 02.9101051 / +39 02.99041382 - Fax: +39 02.9103661 - [info@ventilmotor.com](mailto:info@ventilmotor.com) - [www.ventilmotor.com](http://www.ventilmotor.com)

Cap. Sociale € 10400,00 i.v. - REA 1519030 - N. Registro Imprese MI 53691 - Partita IVA 02632870966

**460**

mm  
H<sub>2</sub>O

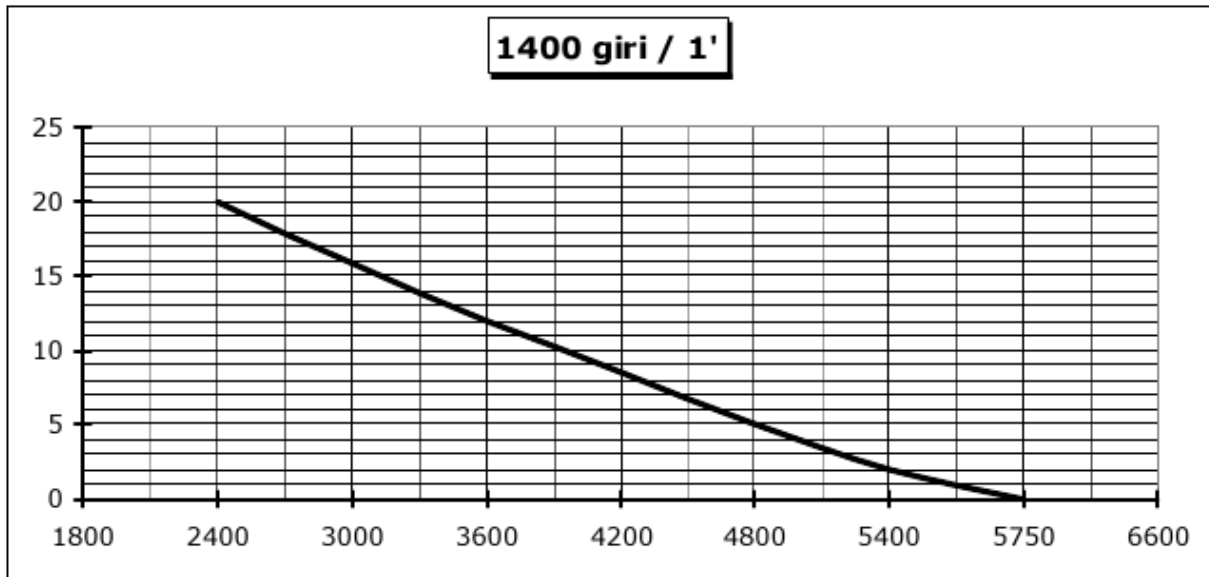

m<sup>3</sup>/h

mm  
H<sub>2</sub>O

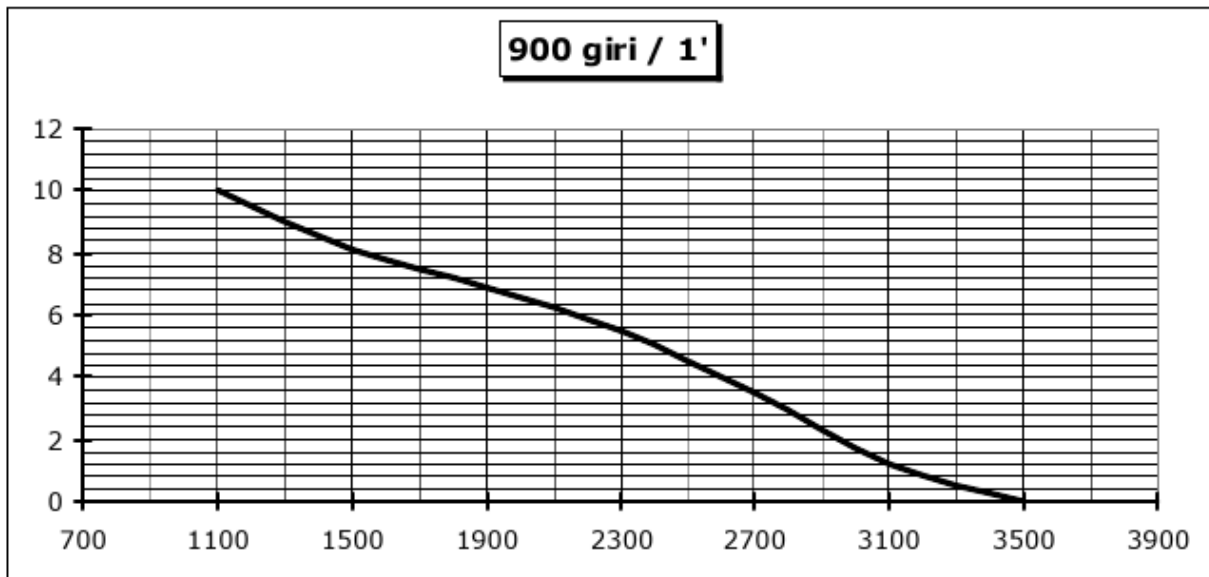

m<sup>3</sup>/h



ISO 9001  
Certificate N° 10-Q-10177-TIC

**Ventilmotor S.r.l. a socio unico**

**Uffici e stabilimento:** Via Piaggio, 74 - 20037 Paderno Dugnano (Mi) - **Sede Legale:** Via G. Pogliani, 34 - Paderno Dugnano (Mi)  
Tel. +39 02.9101051 / +39 02.99041382 - Fax: +39 02.9103661 - [info@ventilmotor.com](mailto:info@ventilmotor.com) - [www.ventilmotor.com](http://www.ventilmotor.com)

Cap. Sociale € 10400,00 i.v. - REA 1519030 - N. Registro Imprese MI 53691 - Partita IVA 02632870966

**510**

mm  
H<sub>2</sub>O

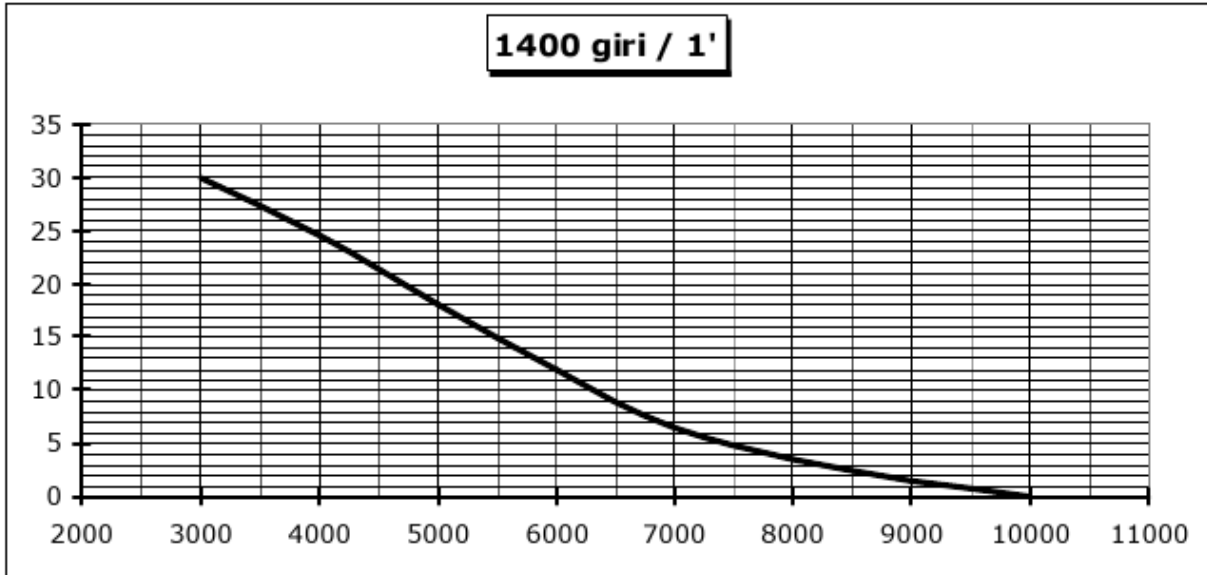

m<sup>3</sup>/h

mm  
H<sub>2</sub>O

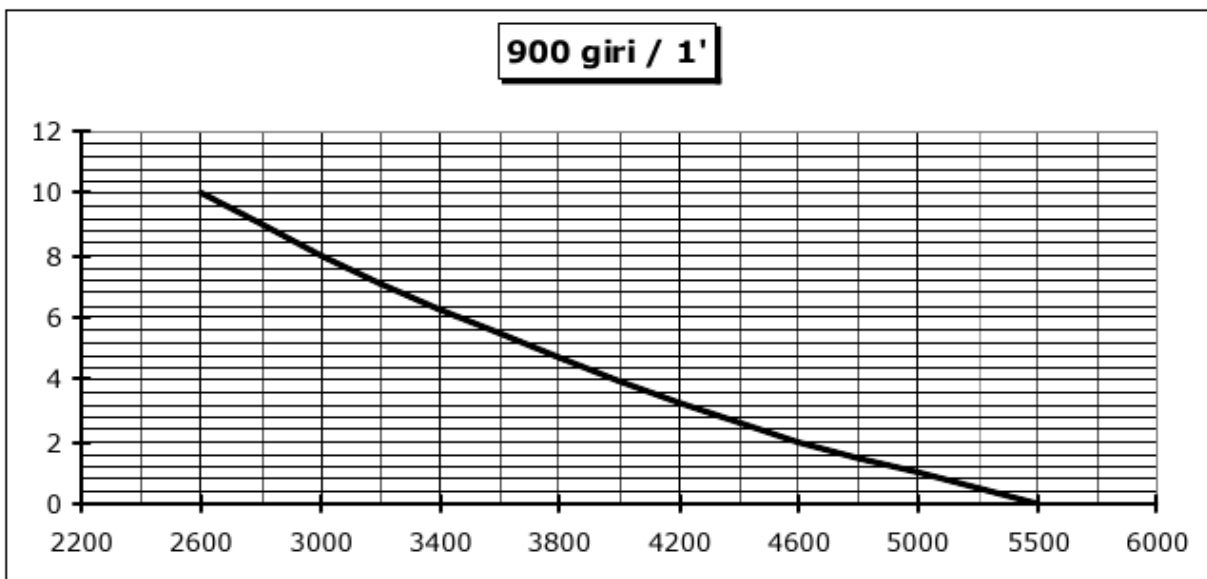

m<sup>3</sup>/h



ISO 9001  
Certificate N° 10-Q-10177-TIC

**Ventilmotor S.r.l. a socio unico**

**Uffici e stabilimento:** Via Piaggio, 74 - 20037 Paderno Dugnano (Mi) - **Sede Legale:** Via G. Pogliani, 34 - Paderno Dugnano (Mi)  
Tel. +39 02.9101051 / +39 02.99041382 - Fax: +39 02.9103661 - [info@ventilmotor.com](mailto:info@ventilmotor.com) - [www.ventilmotor.com](http://www.ventilmotor.com)

Cap. Sociale € 10400,00 i.v. - REA 1519030 - N. Registro Imprese MI 53691 - Partita IVA 02632870966

**560**

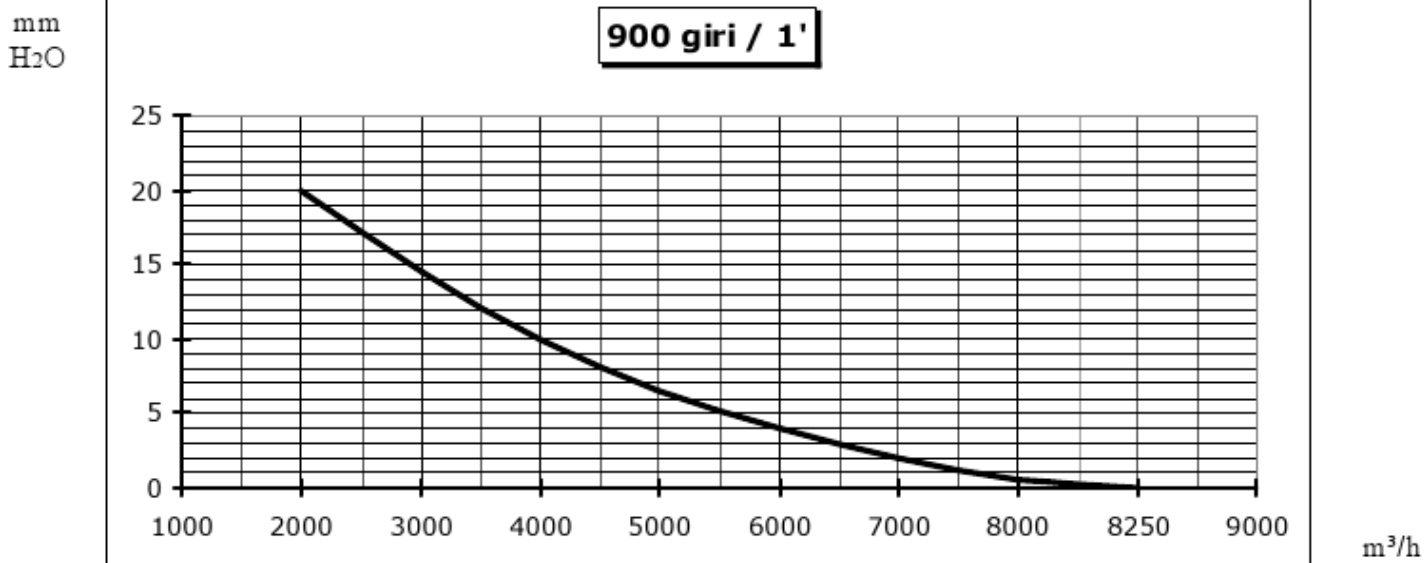
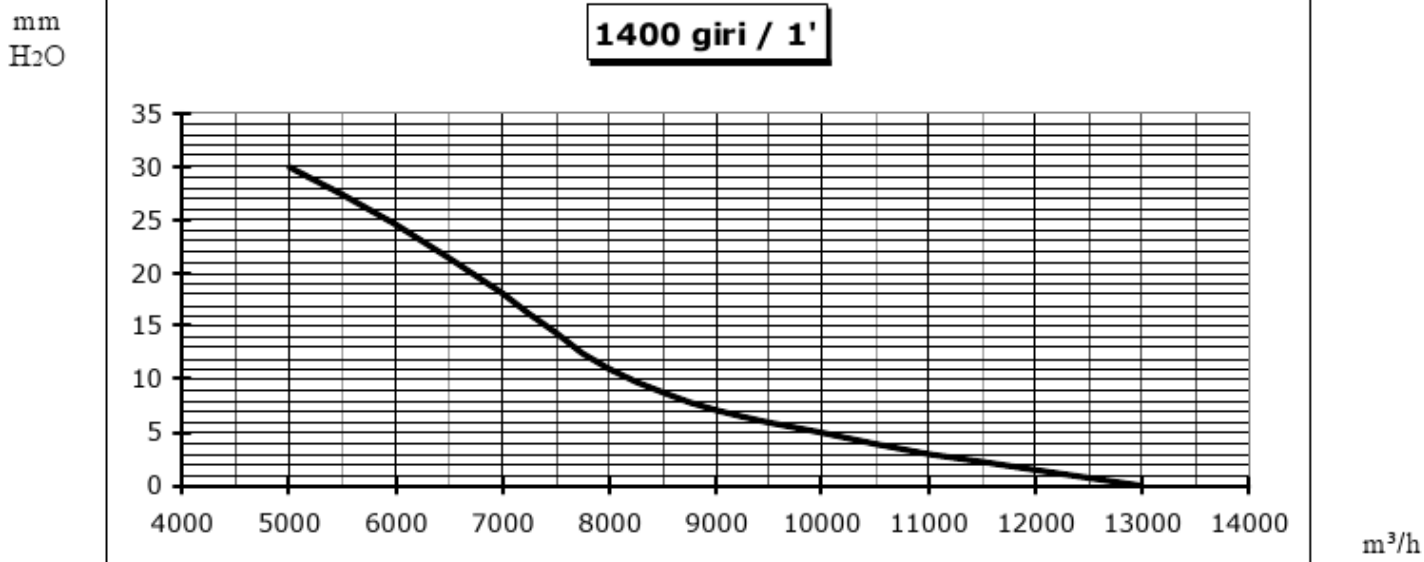

ISO 9001  
Certificate N° 10-Q-10177-TIC

**Ventilmotor S.r.l. a socio unico**

**Uffici e stabilimento:** Via Piaggio, 74 - 20037 Paderno Dugnano (Mi) - **Sede Legale:** Via G. Pogliani, 34 - Paderno Dugnano (Mi)  
Tel. +39 02.9101051 / +39 02.99041382 - Fax: +39 02.9103661 - [info@ventilmotor.com](mailto:info@ventilmotor.com) - [www.ventilmotor.com](http://www.ventilmotor.com)

Cap. Sociale € 10400,00 i.v. - REA 1519030 - N. Registro Imprese MI 53691 - Partita IVA 02632870966



**610**

mm  
H<sub>2</sub>O

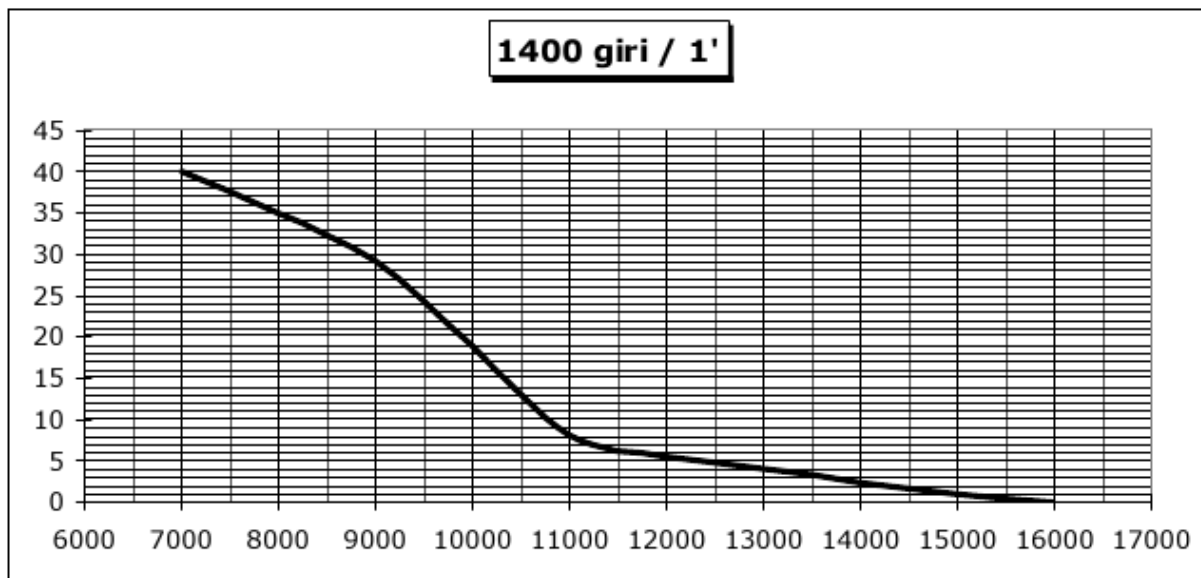

m<sup>3</sup>/h

mm  
H<sub>2</sub>O

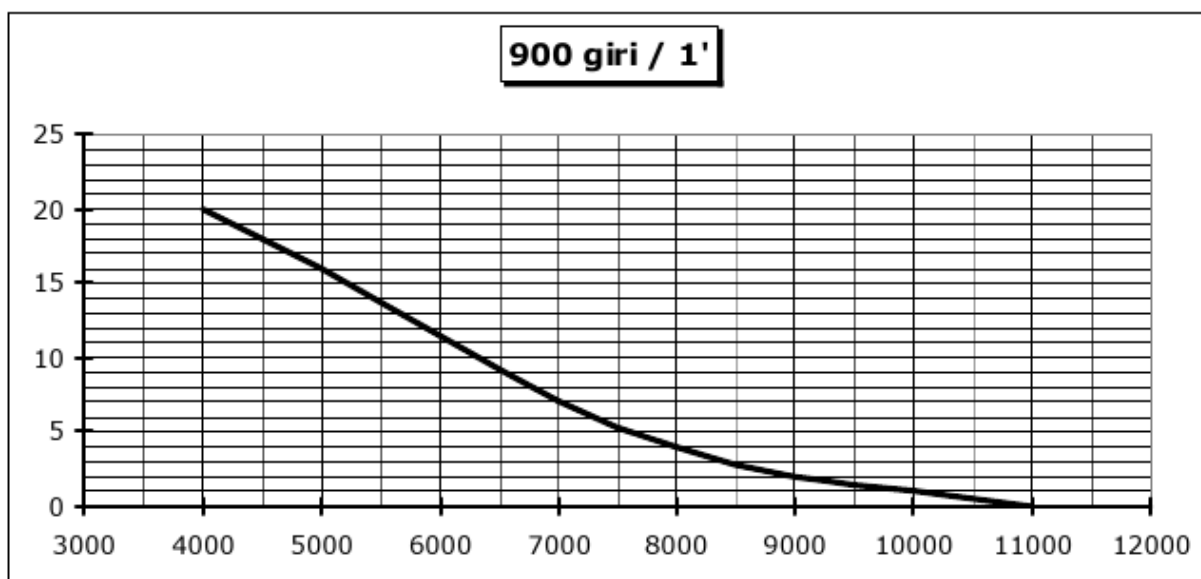

m<sup>3</sup>/h



ISO 9001  
Certificate N° 10-Q-10177-TIC

**Ventilmotor S.r.l. a socio unico**

**Uffici e stabilimento:** Via Piaggio, 74 - 20037 Paderno Dugnano (Mi) - **Sede Legale:** Via G. Pogliani, 34 - Paderno Dugnano (Mi)  
Tel. +39 02.9101051 / +39 02.99041382 - Fax: +39 02.9103661 - [info@ventilmotor.com](mailto:info@ventilmotor.com) - [www.ventilmotor.com](http://www.ventilmotor.com)

Cap. Sociale € 10400,00 i.v. - REA 1519030 - N. Registro Imprese MI 53691 - Partita IVA 02632870966