

SERIE EV-4 VENTILATORE ELICOIDALE



DESTINAZIONE D'USO

- Adatto a ricambiare l'aria nell'ambiente e per altri usi industriali specifici
- Dotato di boccaglio convogliatore, supporto motore, rete di protezione
- Numero di pale: 4

DATI TECNICI

- Motore 1400 Giri / 1', da 130 a 736 W: Portata da 300 a 13500 m³/h con pressione fino a 15 mm H₂O, secondo grandezze e potenze
- Motore 900 Giri / 1', da 184 a 243 W: Portata da 700 a 8300 m³/h con pressione fino a 10 mm H₂O, secondo grandezze e potenze



ISO 9001
Certificate N° 10-Q-10177-TIC

Ventilmotor S.r.l. a socio unico

Uffici e stabilimento: Via Piaggio, 74 - 20037 Paderno Dugnano (Mi) - **Sede Legale:** Via G. Pogliani, 34 - Paderno Dugnano (Mi)
Tel. +39 02.9101051 / +39 02.99041382 - Fax: +39 02.9103661 - info@ventilmotor.com - www.ventilmotor.com
Cap. Sociale € 10400,00 i.v. - REA 1519030 - N. Registro Imprese MI 53691 - Partita IVA 02632870966

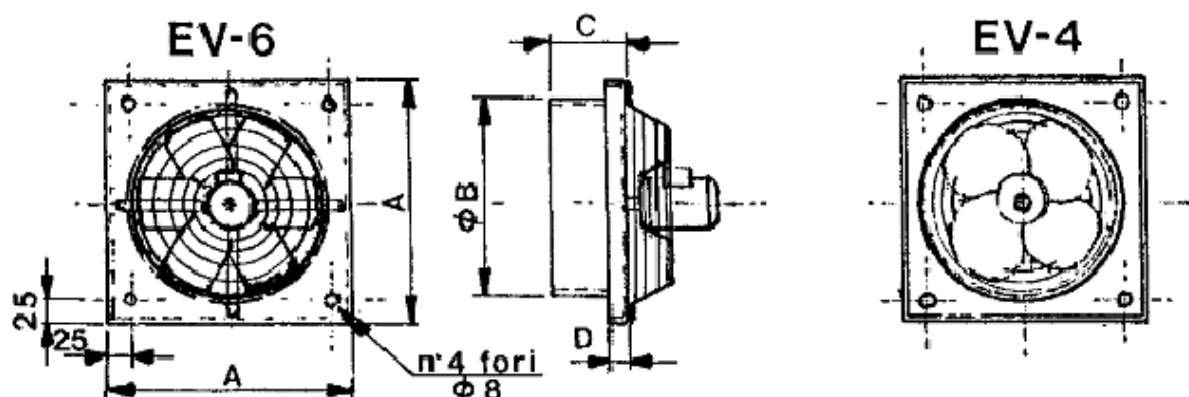

| MODELLO | EV-4 260 | EV-4 310 | EV-4 360 | EV-4 410 | EV-4 460 | EV-4 510 | EV-4 560 | EV-4 610 |
|---------|-------------|-------------|-------------|-------------|-------------|-------------|-------------|-------------|
| A | 350 | 400 | 450 | 500 | 550 | 600 | 680 | 715 |
| B | 300 | 350 | 400 | 450 | 500 | 550 | 630 | 680 |
| C | 65 | 65 | 65 | 65 | 65 | 65 | 65 | 65 |
| D | 15 | 15 | 15 | 15 | 15 | 15 | 15 | 15 |

| MODELLO | EV-4 260 | EV-4 310 | EV-4 360 | EV-4 410 | EV-4 460 | EV-4 510 | EV-4 560 | EV-4 610 | |
|---|---------------|---------------|---------------|----------------|----------------|----------------|----------------|-----------------|------|
| Giri / 1' 1400 | Hp | 0,18 | 0,18 | 0,18 | 0,25 | 0,33 | 0,5 | 0,75 | 1 |
| | W | 130 | 130 | 130 | 184 | 243 | 368 | 552 | 736 |
| Portata Min./Max. (m ³ /h) | 300 / 1100 | 900 / 2400 | 900 / 2500 | 1500 / 3500 | 2400 / 5400 | 4000 / 6500 | 6000 / 9000 | 9000 / 13500 | |
| Pressione max. (mm H ₂ O) | 10 | 10 | 15 | 15 | 15 | 15 | 15 | 15 | |
| Giri / 1' 900 | Hp | - | - | 0,25 | 0,25 | 0,25 | 0,25 | 0,25 | 0,33 |
| | W | - | - | 184 | 184 | 184 | 184 | 184 | 243 |
| Portata Min./Max. (m ³ /h) | - | - | 700 / 1450 | 700 / 2100 | 1700 / 3100 | 3000 / 4200 | 4000 / 5800 | 6500 / 8300 | |
| Pressione max. (mm H ₂ O) | - | - | 5 | 10 | 5 | 5 | 5 | 5 | |

mm
H₂O

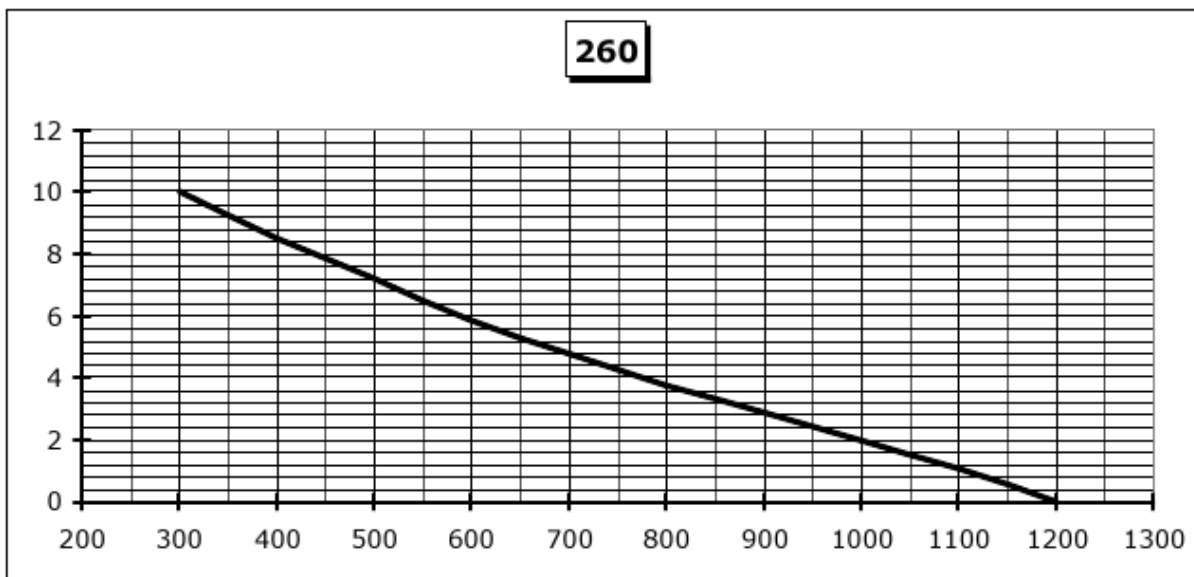

m³/h

mm
H₂O

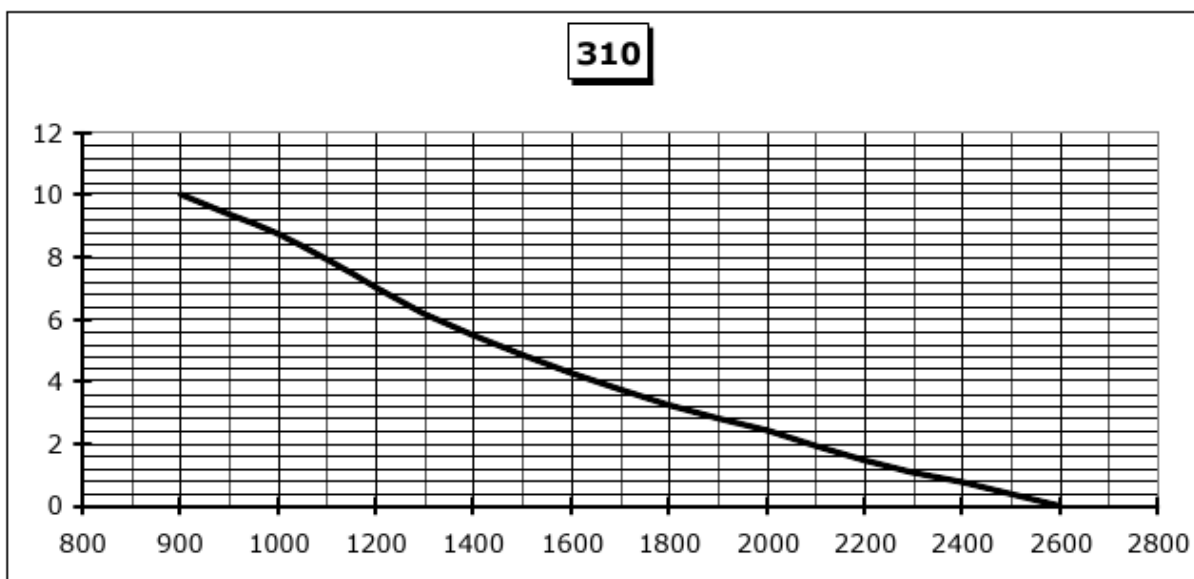

m³/h



ISO 9001
Certificate N° 10-Q-10177-TIC

Ventilmotor S.r.l. a socio unico

Uffici e stabilimento: Via Piaggio, 74 - 20037 Paderno Dugnano (Mi) - **Sede Legale:** Via G. Pogliani, 34 - Paderno Dugnano (Mi)
Tel. +39 02.9101051 / +39 02.99041382 - Fax: +39 02.9103661 - info@ventilmotor.com - www.ventilmotor.com

Cap. Sociale € 10400,00 i.v. - REA 1519030 - N. Registro Imprese MI 53691 - Partita IVA 02632870966

360

mm
H₂O

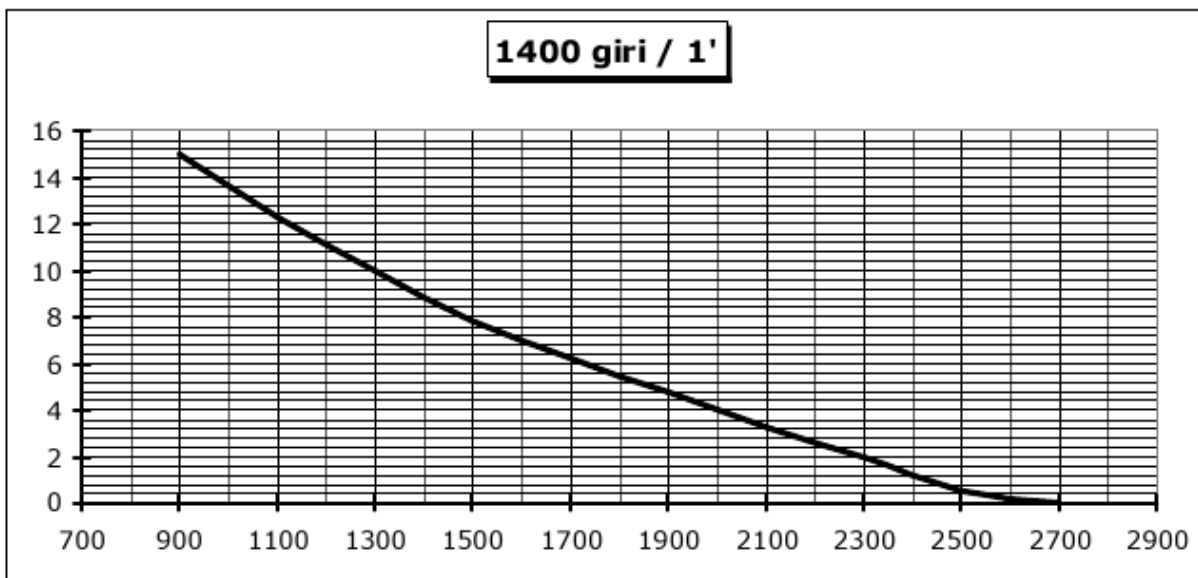

m³/h

mm
H₂O

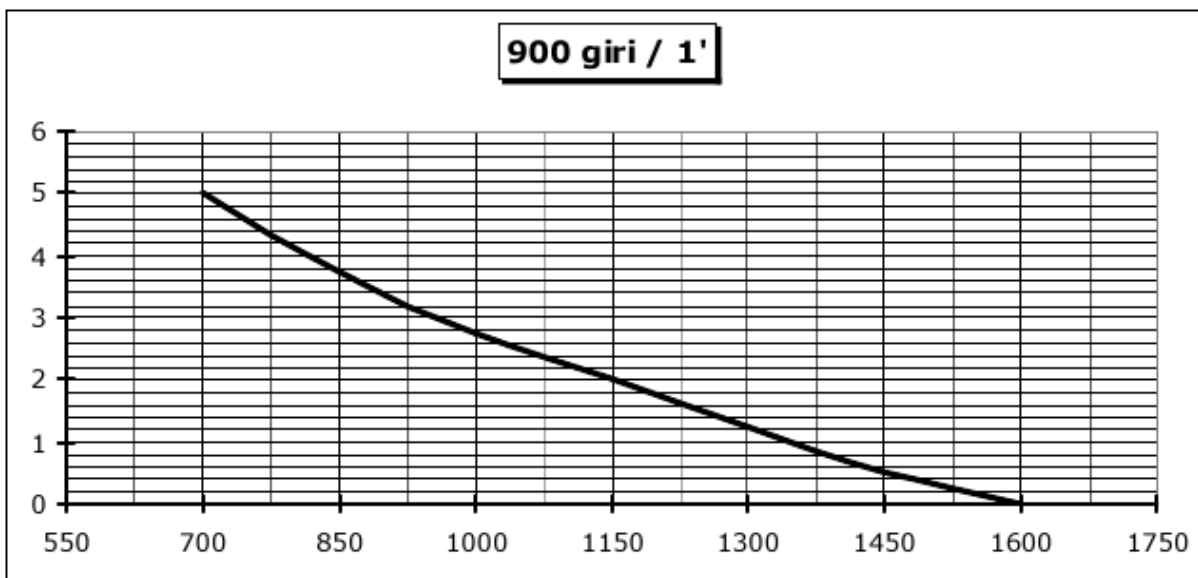

m³/h



ISO 9001
Certificate N° 10-Q-10177-TIC

Ventilmotor S.r.l. a socio unico

Uffici e stabilimento: Via Piaggio, 74 - 20037 Paderno Dugnano (Mi) - **Sede Legale:** Via G. Pogliani, 34 - Paderno Dugnano (Mi)
Tel. +39 02.9101051 / +39 02.99041382 - Fax: +39 02.9103661 - info@ventilmotor.com - www.ventilmotor.com

Cap. Sociale € 10400,00 i.v. - REA 1519030 - N. Registro Imprese MI 53691 - Partita IVA 02632870966

410

mm
H₂O

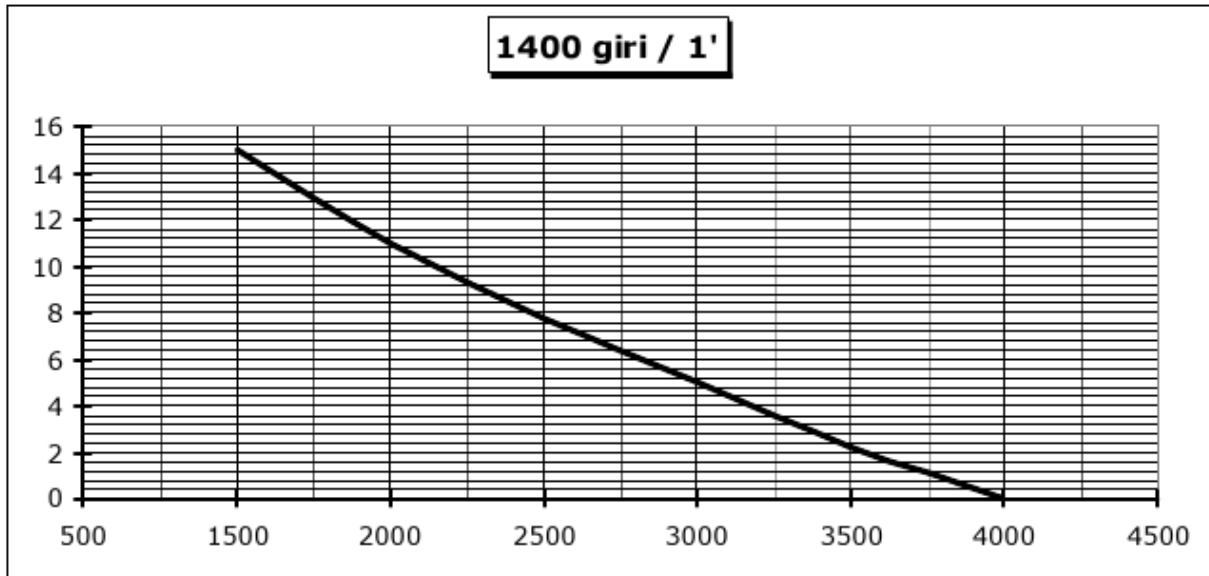

m³/h

mm
H₂O

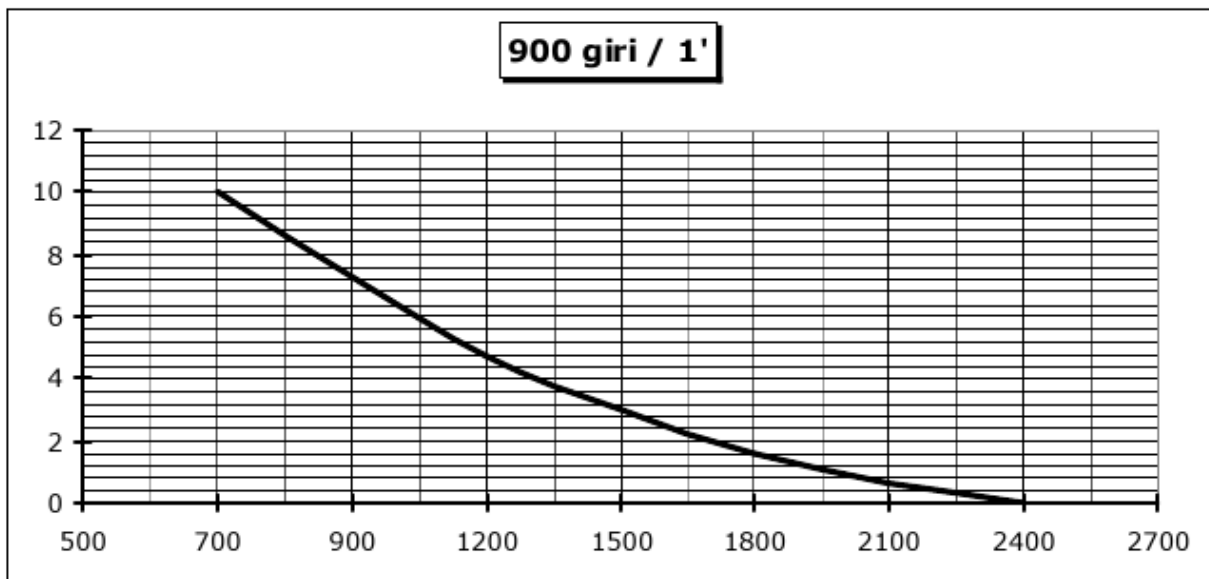

m³/h



ISO 9001
Certificate N° 10-Q-10177-TIC

Ventilmotor S.r.l. a socio unico

Uffici e stabilimento: Via Piaggio, 74 - 20037 Paderno Dugnano (Mi) - **Sede Legale:** Via G. Pogliani, 34 - Paderno Dugnano (Mi)
Tel. +39 02.9101051 / +39 02.99041382 - Fax: +39 02.9103661 - info@ventilmotor.com - www.ventilmotor.com

Cap. Sociale € 10400,00 i.v. - REA 1519030 - N. Registro Imprese MI 53691 - Partita IVA 02632870966

460

mm
H₂O

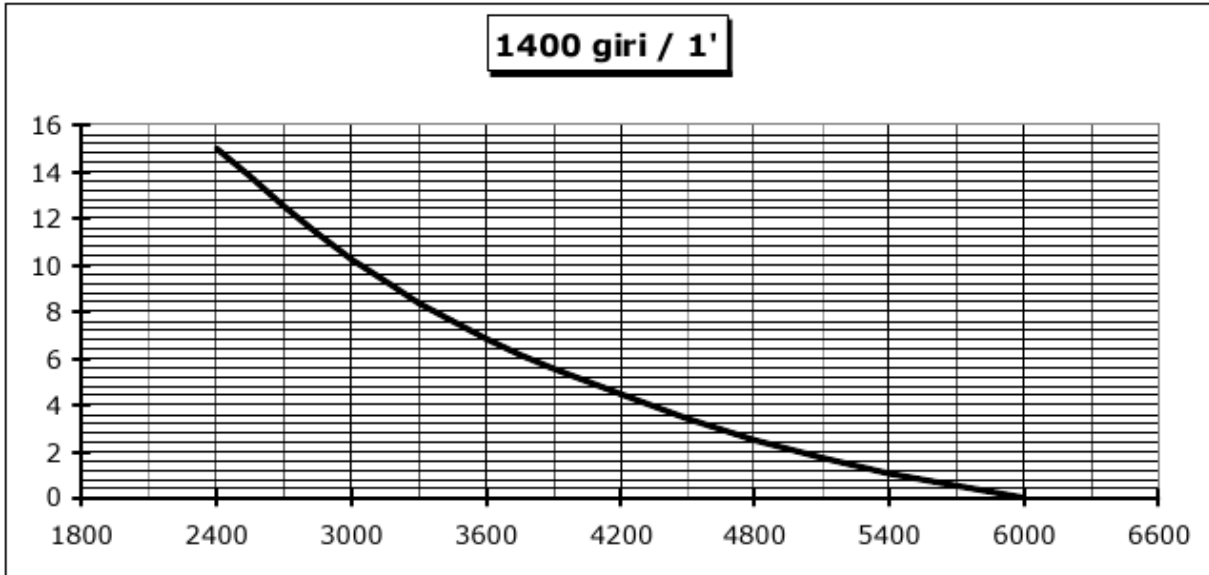

m³/h

mm
H₂O

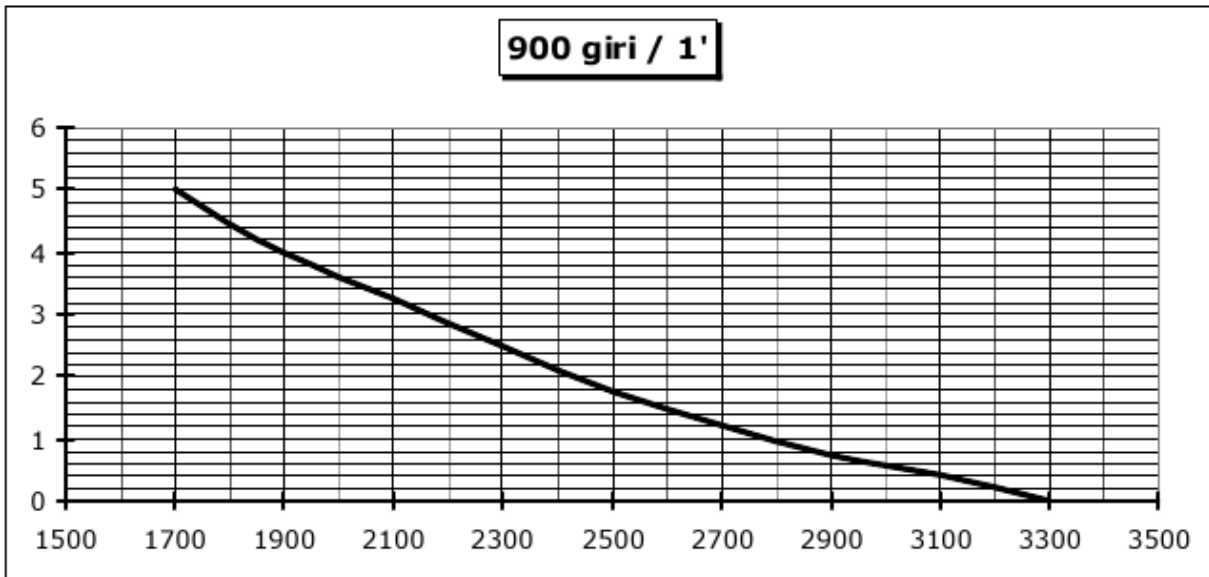

m³/h



ISO 9001
Certificate N° 10-Q-10177-TIC

Ventilmotor S.r.l. a socio unico

Uffici e stabilimento: Via Piaggio, 74 - 20037 Paderno Dugnano (Mi) - **Sede Legale:** Via G. Pogliani, 34 - Paderno Dugnano (Mi)
Tel. +39 02.9101051 / +39 02.99041382 - Fax: +39 02.9103661 - info@ventilmotor.com - www.ventilmotor.com

Cap. Sociale € 10400,00 i.v. - REA 1519030 - N. Registro Imprese MI 53691 - Partita IVA 02632870966

510

mm
H₂O

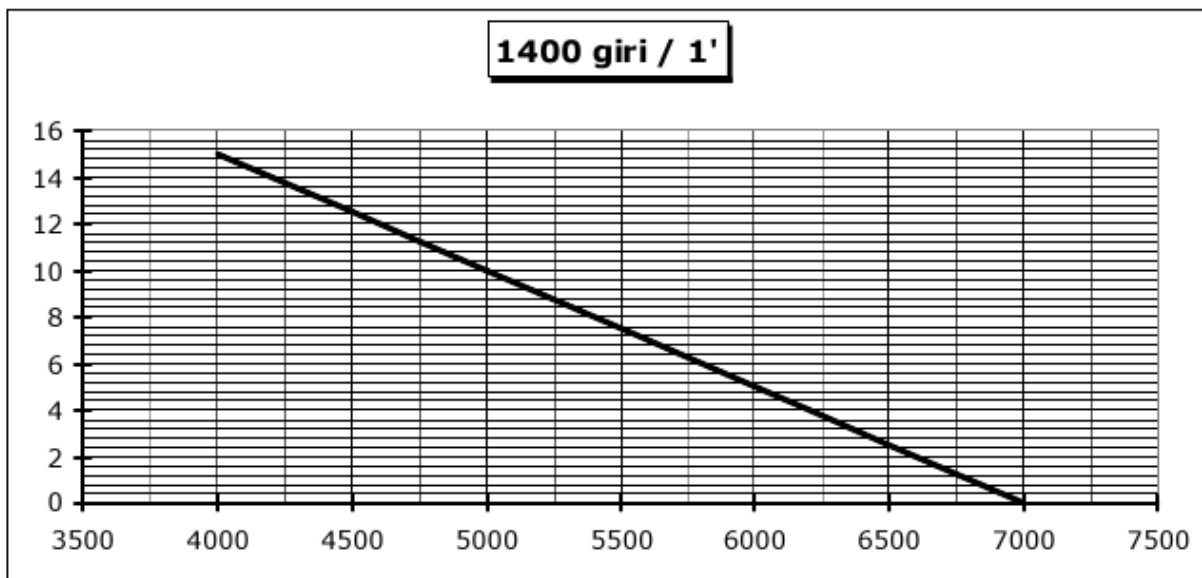

m³/h

mm
H₂O

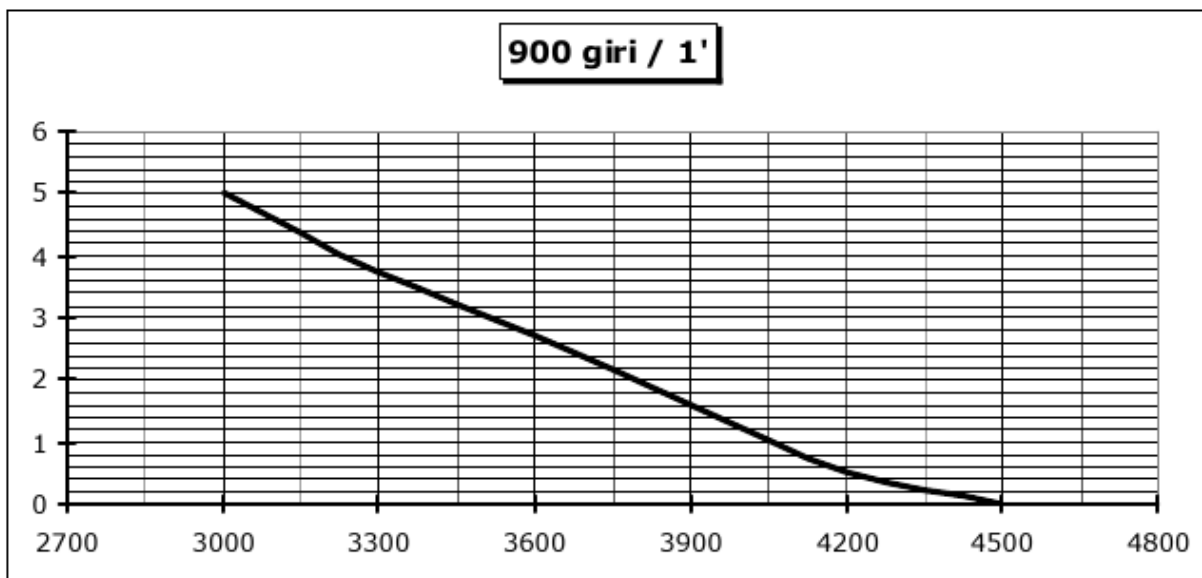

m³/h



ISO 9001
Certificate N° 10-Q-10177-TIC

Ventilmotor S.r.l. a socio unico

Uffici e stabilimento: Via Piaggio, 74 - 20037 Paderno Dugnano (Mi) - **Sede Legale:** Via G. Pogliani, 34 - Paderno Dugnano (Mi)
Tel. +39 02.9101051 / +39 02.99041382 - Fax: +39 02.9103661 - info@ventilmotor.com - www.ventilmotor.com

Cap. Sociale € 10400,00 i.v. - REA 1519030 - N. Registro Imprese MI 53691 - Partita IVA 02632870966

560

mm
H₂O

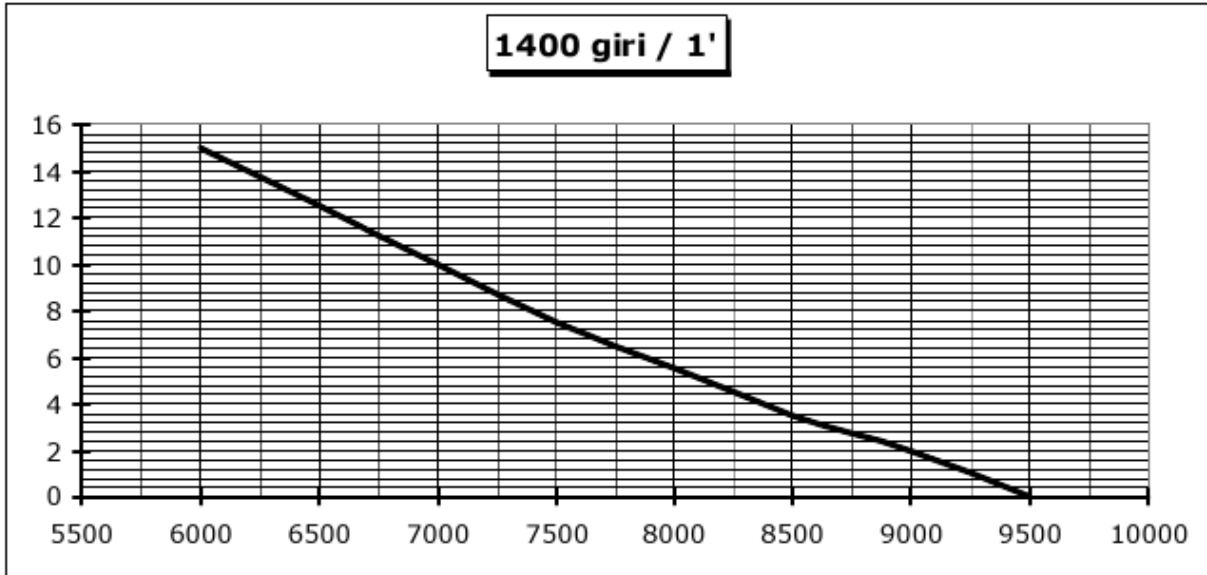

m³/h

mm
H₂O

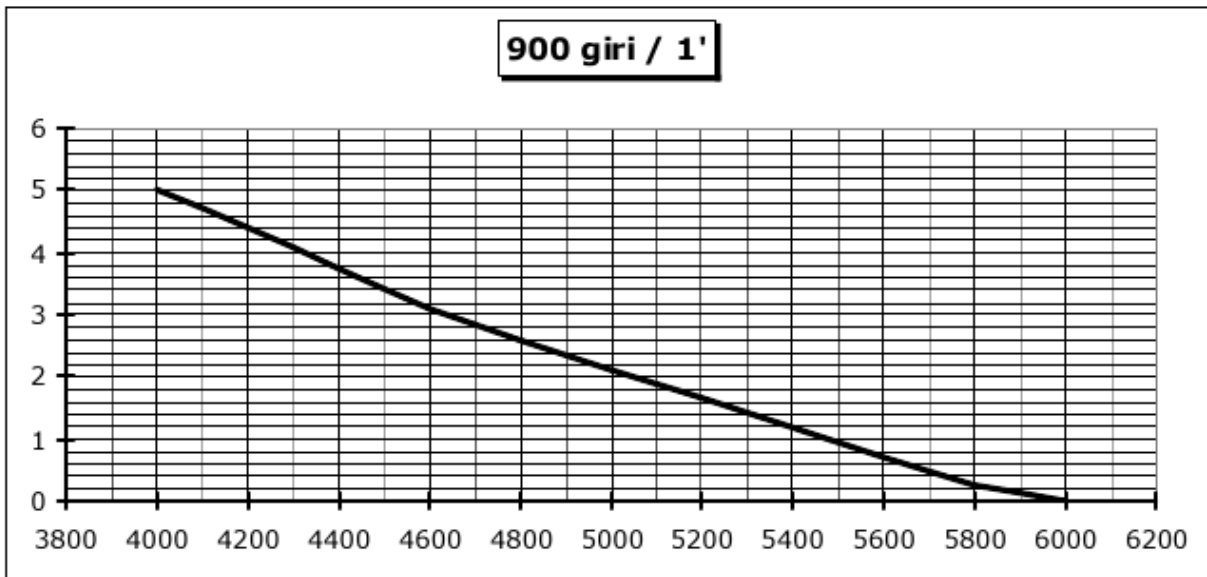

m³/h



ISO 9001
Certificate N° 10-Q-10177-TIC

Ventilmotor S.r.l. a socio unico

Uffici e stabilimento: Via Piaggio, 74 - 20037 Paderno Dugnano (Mi) - **Sede Legale:** Via G. Pogliani, 34 - Paderno Dugnano (Mi)
Tel. +39 02.9101051 / +39 02.99041382 - Fax: +39 02.9103661 - info@ventilmotor.com - www.ventilmotor.com

Cap. Sociale € 10400,00 i.v. - REA 1519030 - N. Registro Imprese MI 53691 - Partita IVA 02632870966

610

mm
H₂O

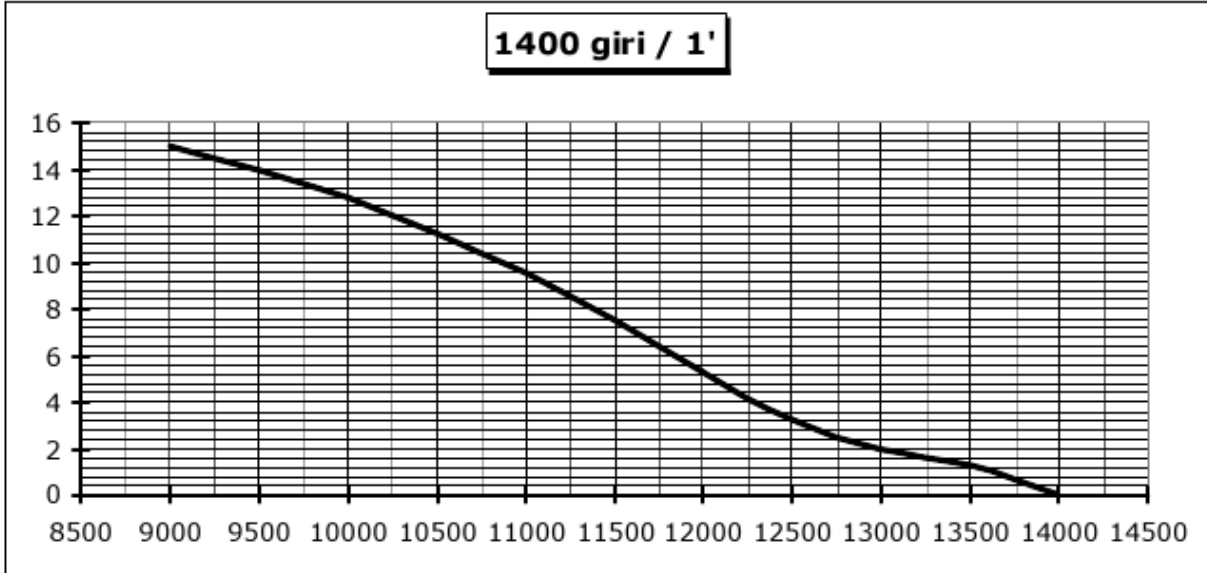

m³/h

mm
H₂O

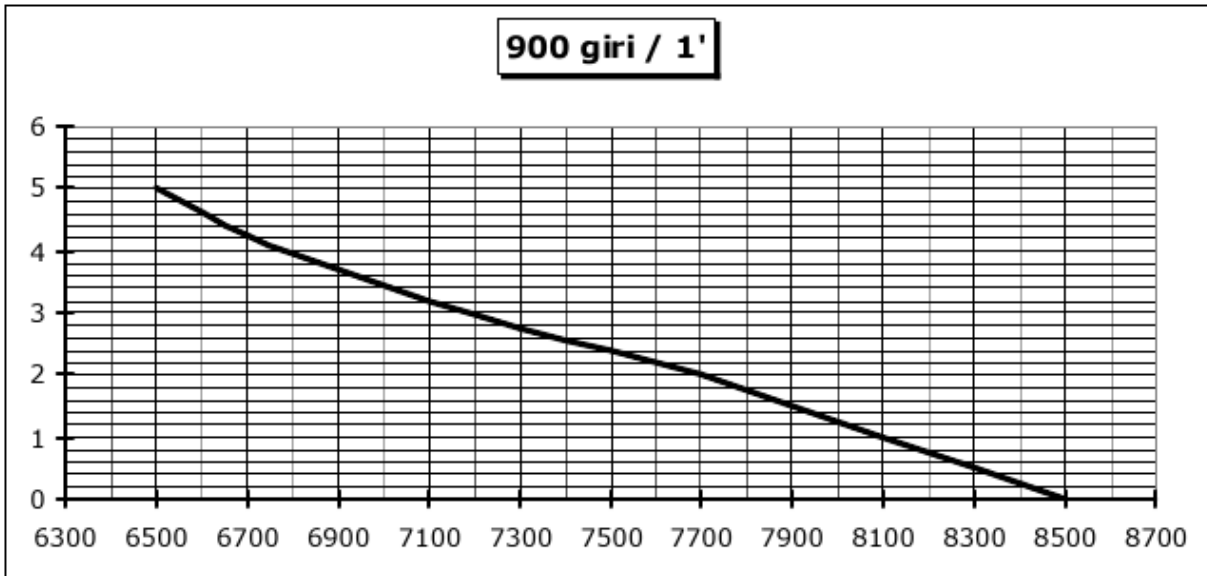

m³/h



ISO 9001
Certificate N° 10-Q-10177-TIC

Ventilmotor S.r.l. a socio unico

Uffici e stabilimento: Via Piaggio, 74 - 20037 Paderno Dugnano (Mi) - **Sede Legale:** Via G. Pogliani, 34 - Paderno Dugnano (Mi)
Tel. +39 02.9101051 / +39 02.99041382 - Fax: +39 02.9103661 - info@ventilmotor.com - www.ventilmotor.com

Cap. Sociale € 10400,00 i.v. - REA 1519030 - N. Registro Imprese MI 53691 - Partita IVA 02632870966